

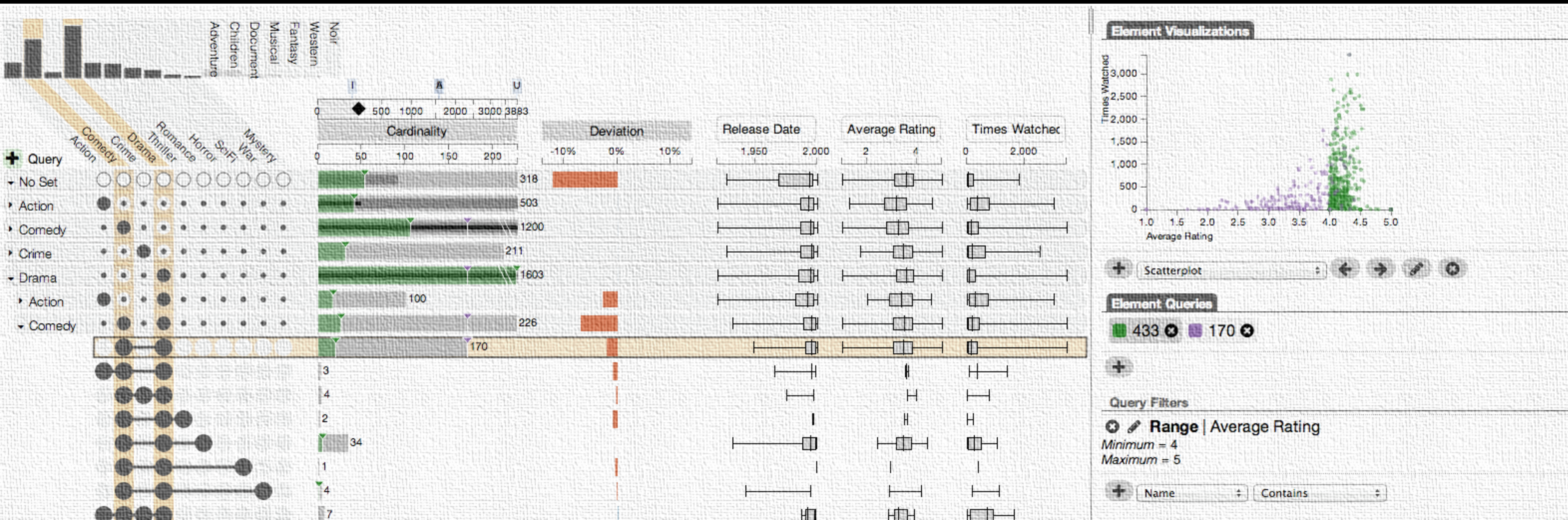

Enabling Scientific Discovery through Interactive Visual Data Analysis



visualization

pictures

The purpose of computing is insight, not numbers.

- Richard Wesley Hamming

- Card, Mackinlay, Shneiderman

Banana

M. acuminata

Date

P. dactylifera

Cress

Arabidopsis thaliana

Rice

Oryza sativa

Sorghum

Sorghum bicolor

Brome

Brachypodium distachyon

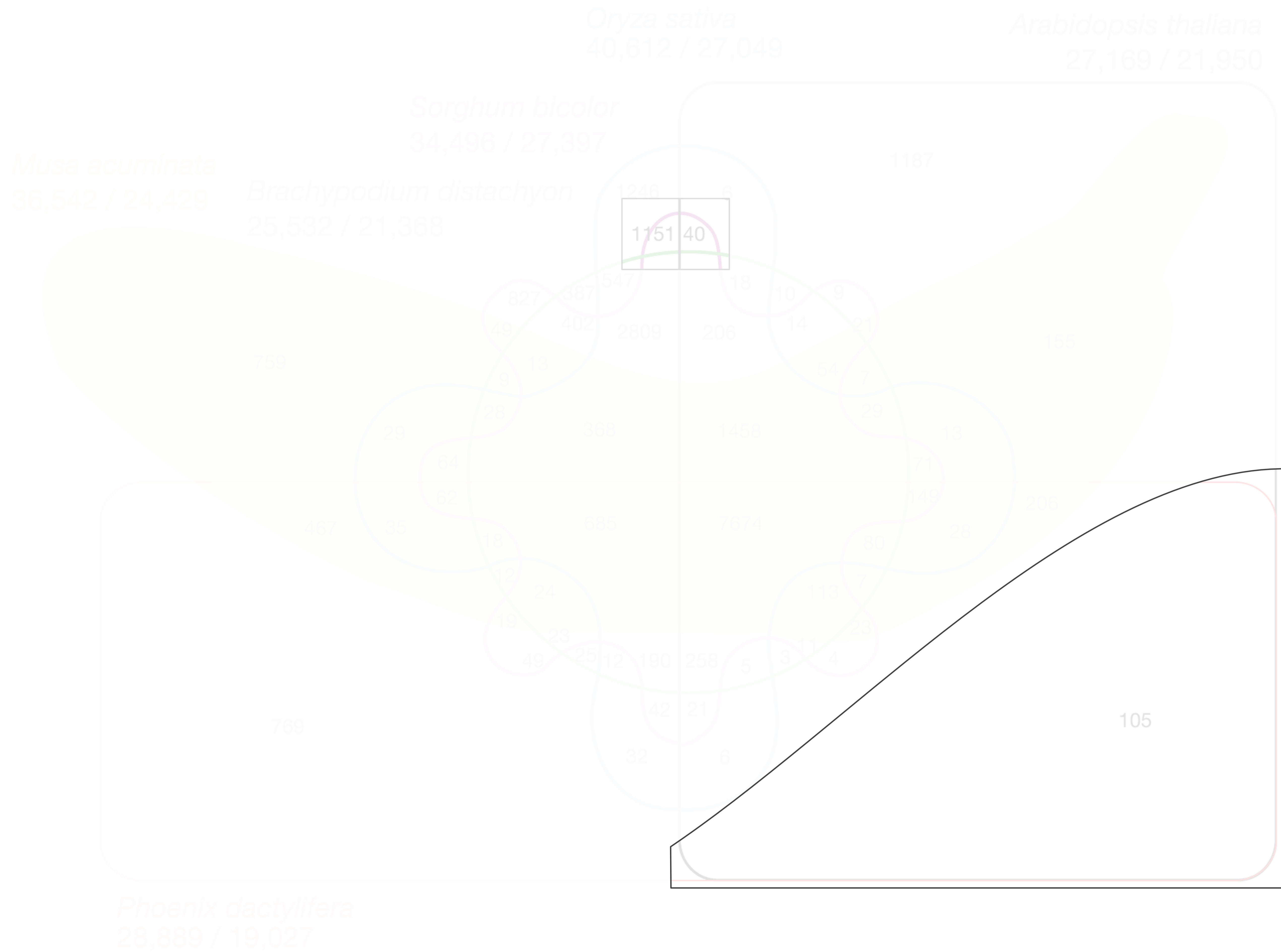

Good Data Visualization

- ... makes data **accessible**
- ... combines strengths of **humans and computers**
- ... enables **insight**
- ... **communicates**

Purpose of Visualization

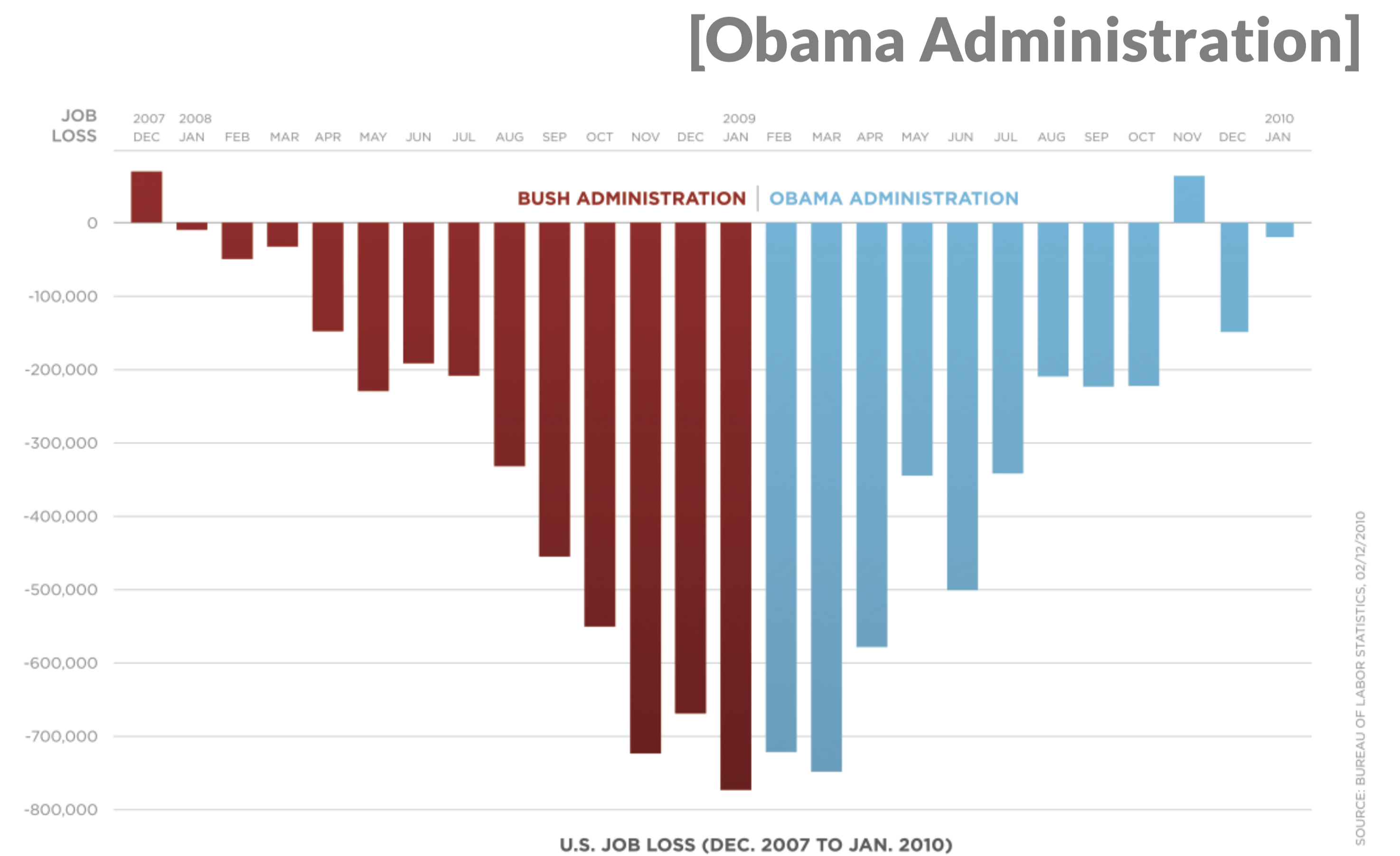
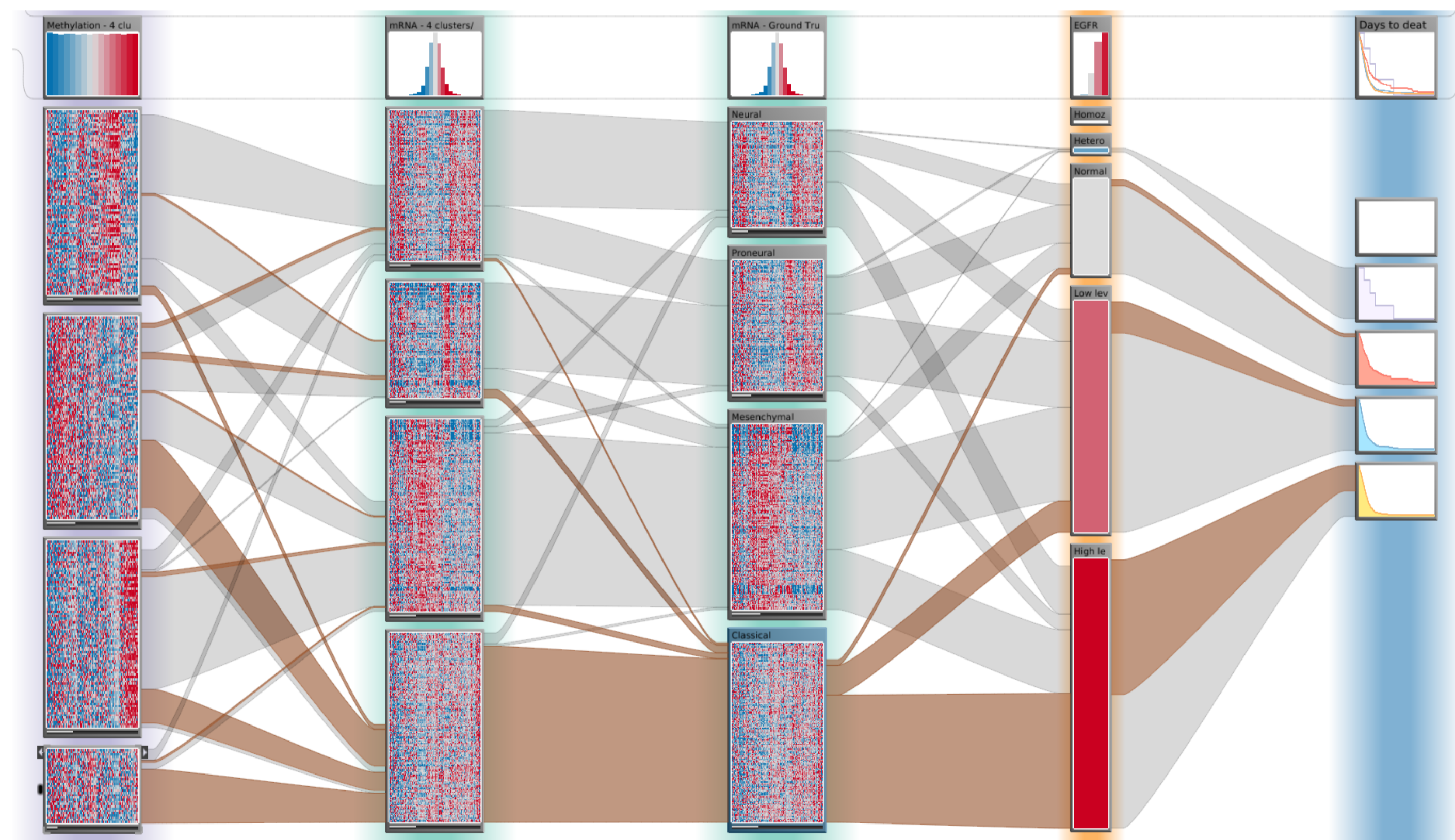

←

Open Exploration

→

Communication

Research Approach

Technique Driven

Solving a general visual analysis problem

Broad application

General questions

How to visualize many sets?

How to make rankings interactive?

Visualization Method

Problem Driven

Solving a domain problem of collaborator

Complex, targeted systems

Help answer important questions

What characterizes a cancer subtype?

Which drug works for these patients?

Visualization Application

Content

Techniques

Domain Solution

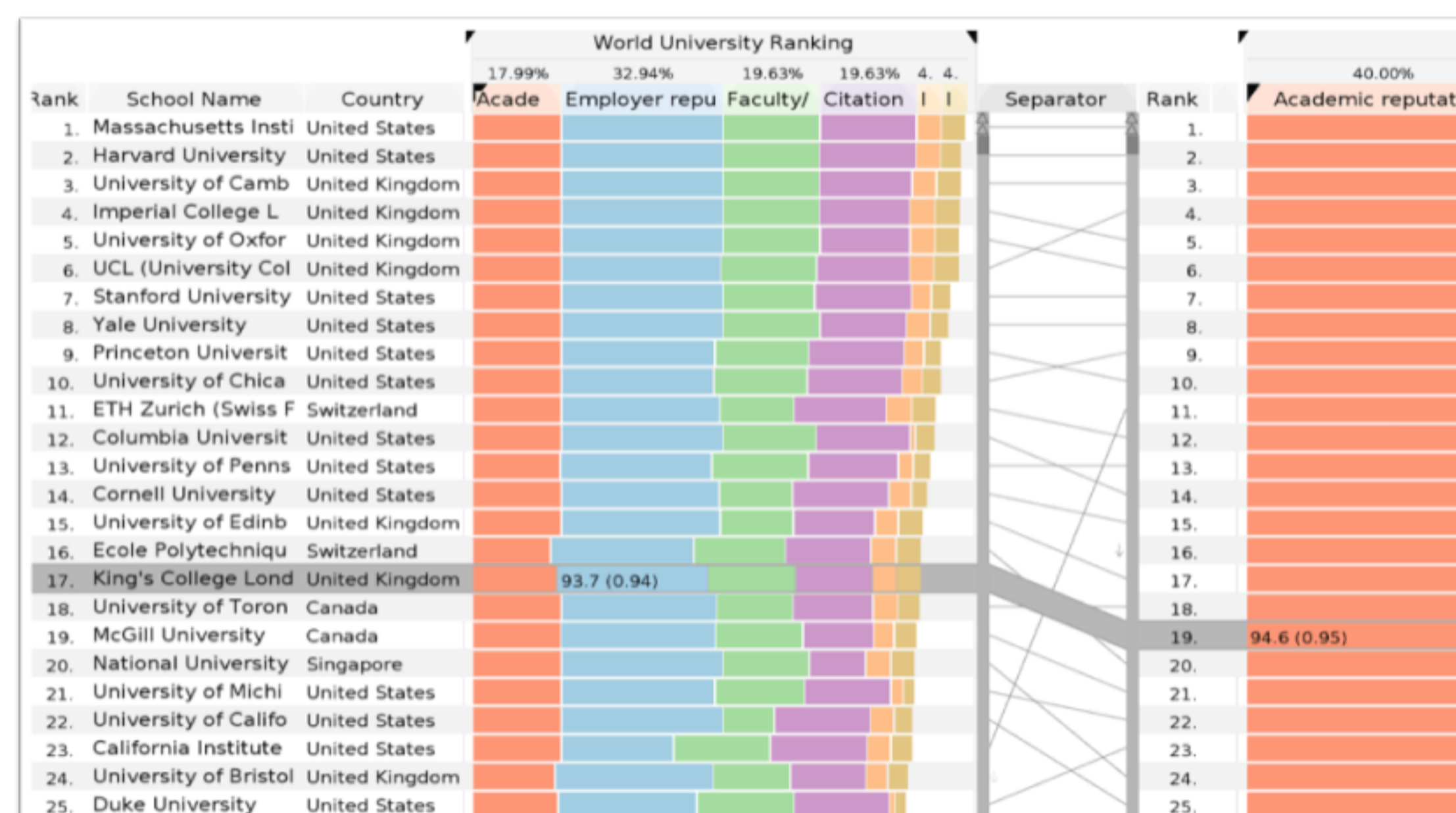

Multi-Attribute Rankings

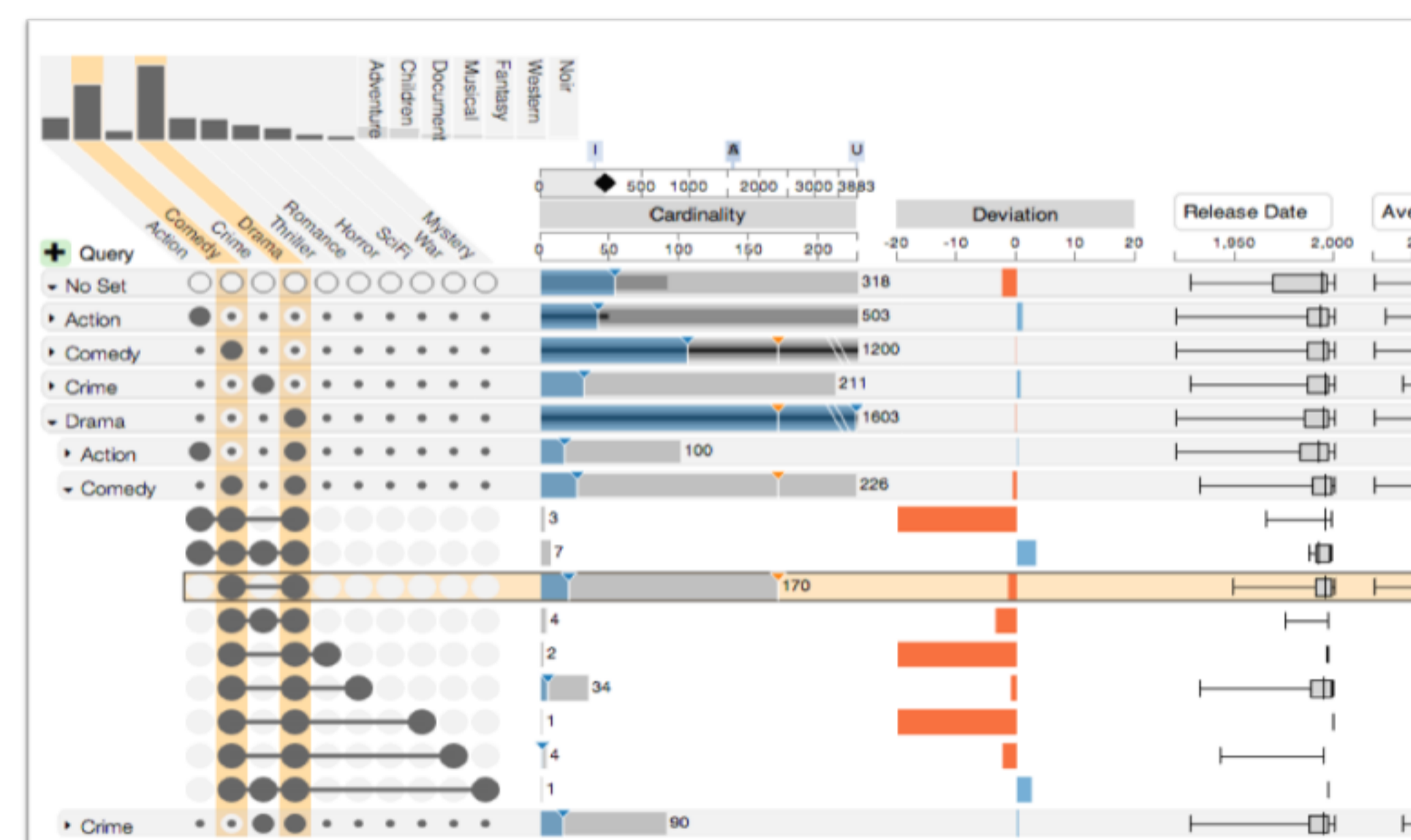

Set Visualization

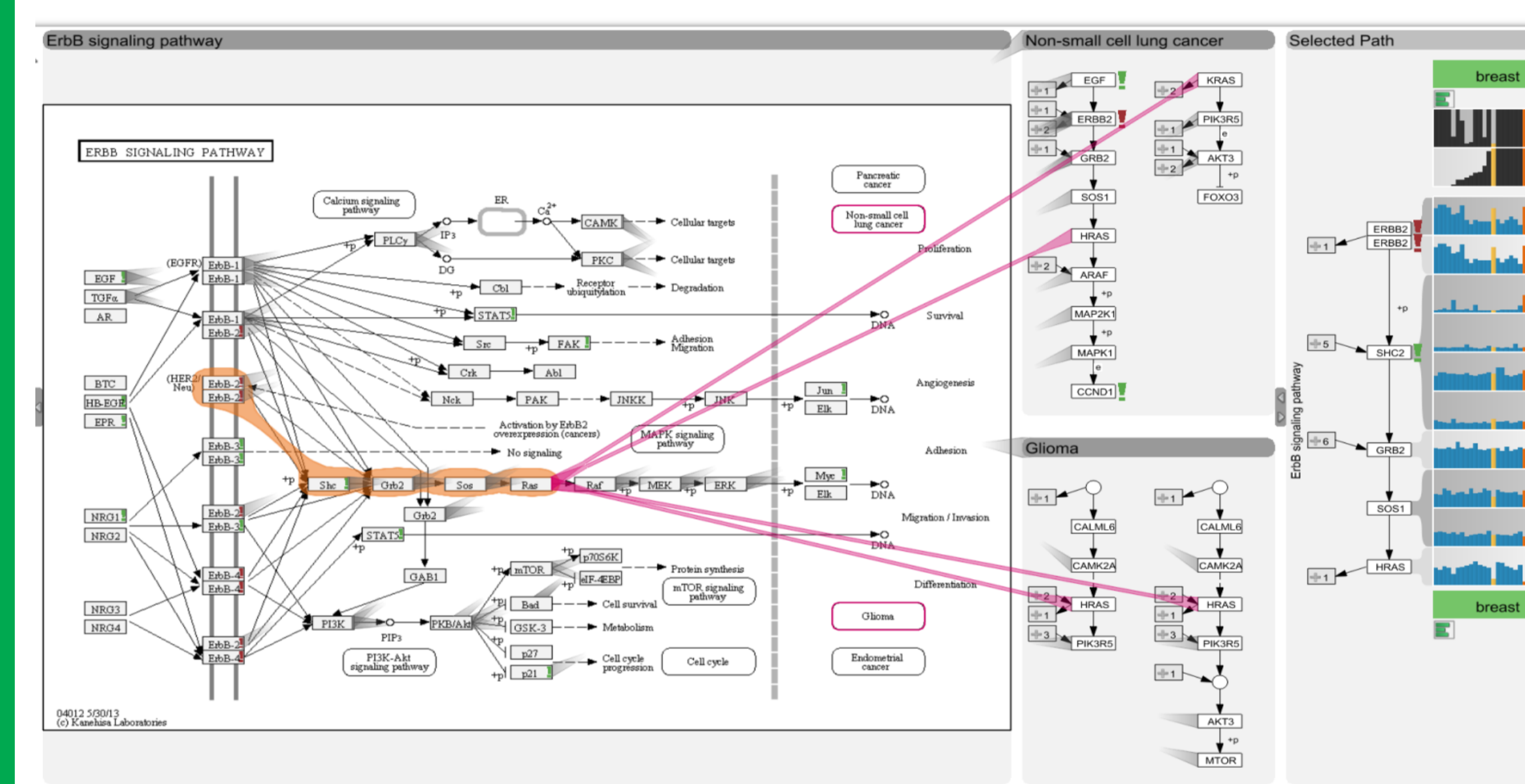

Multivariate Networks Pathway Analysis

Lay Users

Expert Analysts

[InfoVis '13]

Best Paper Award

Rankings

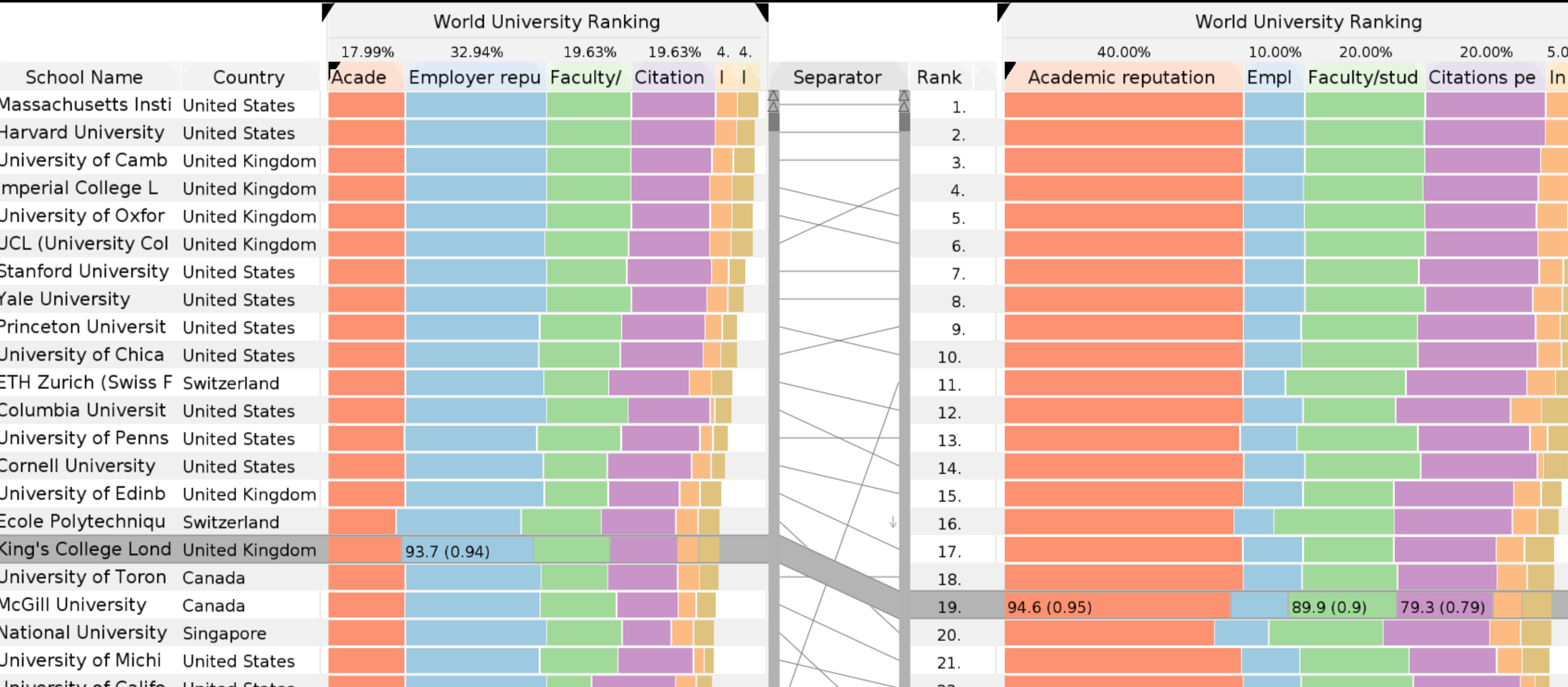



Rankings are popular

iTunes Store Top 10 Song

Rank	Artist	Song
1.	Katy Perry	Roar
2.	Avicii	Wake Me Up
3.	Lorde	Royals
4.	Lady Gaga	Applause
5.	Miley Cyrus	Wrecking Ball
6.	Drake	Hold On, We're Going Home (feat. Majid Jordan)
7.	Pharrell	Blurred Lines (feat. T.I. & Robin Thicke)
8.	Justin Bieber	What My Kind of Night
9.	Miley Cyrus	Can't Stop
10.	Line Dragons	Proactive

World University Rankings - 2012

QS RANK	SCHOOL NAME	COUNTRY	QS STARS RATING	OVERALL	ACADEMIC REPUTATION	EMPLOYER REPUTATION	FACULTY STUDENT	INTERNATIONAL FACULTY	INTERNATIONAL STUDENTS	CITATIONS PER FACULTY
1	Massachusetts Institute of Technology (MIT)	United States	5	100.00	100	100	100	100	100	100
2	University of Cambridge	United Kingdom	5	99.7	100	100	100	100	100	100
3	Harvard University	United States	5	99.9	100	100	100	100	100	100
4	UCL (University College London)	United Kingdom	5	99.9	100	100	100	100	100	100
5	University of Oxford	United Kingdom	5	99.9	100	100	100	100	100	100

US News BEST CARS

Affordable Small Cars

Rank	Model	Performance	Interior	Safety	Reliability	MSRP
1	Toyota Yaris	8.0	8.9	9.0	3.5	12,000
2	Honda Fit	8.0	8.3	9.3	3.5	13,000
3	Ford Fiesta	8.0	8.3	9.3	3.5	13,000
4	Hyundai Accent	8.0	8.3	9.3	3.5	13,000
5	Vauxhall Corsa	8.0	8.3	9.3	3.5	13,000

SJR Journal Rankings

Rank	Title	SJR	H Index	Total Docs. (2012)	Total Docs. (3years)	Total Refs.	Total Cites (3years)	Citable Docs. (3years)	Cites / Doc. (2years)	Ref. / Doc.	Country
1	IEEE Transactions on Pattern Analysis and Machine Intelligence	8.094	200	196	579	8,249	5,724	543	9.43	42.09	USA
2	ACM Computing Surveys	6,751	81	196	65	4,962	894	10	8.72	130.58	USA
3	Foundations and Trends in Information Retrieval	6,536	12	38	10	1,746	151	64	6.12	221.33	USA
4	International Journal of Computer Vision	6,167	121	3	65	5,111	894	11	4.91	44.83	USA
5	Foundations and Trends in Networking	5,997	11	114	9	968	71	10	13.86	35.85	USA

U.S. and Canada Box Office

Rank	Title	Distributor	Weekend Gross	Cumulative Gross	Wks Out	# of Theaters
1	The Weinstein Company	The Weinstein Company	\$20,201,300	\$79,466,400	3	3330
2	EST MODUS IN REBUS	Horatio (Saline 1,1,106)	\$18,472,900	\$18,472,900	1	2735

The World's Billionaires

Rank	Name	Net Worth	Industry
1	Larry Ellison	\$43 B	69 diversified
2	Charles Koch	\$34 B	77 diversified
3	David Koch	\$34 B	73 diversified
4	Michael Bloomberg	\$31 B	85 L'Oréal
5	Li Ka-shing	\$31 B	90

Things to do in Atlanta

Rank	Attraction	Reviews
1	Fox Theatre	976 reviews
2	Atlanta Botanical Garden	697 reviews

World University Rankings - 2011 - 2012

Rank	Institution	Country	Score
1	California Institute of Technology	United States	93.7
2	University of Oxford	United Kingdom	93.6
3	Stanford University	United States	92.7
4	Harvard University	United States	92.6
5	Massachusetts Institute of Technology	United States	90.6
6	Princeton University	United Kingdom	90.5
7	University of Cambridge	United Kingdom	90.4

Bestenliste Vergleich: Handys im Test

Rank	Produkt	Preis	Gesamtwertung
1	Samsung Galaxy S4	ab 470,00 €	95.1
2	Sony Xperia Z	ab 442,00 €	95.7
3	HTC One	ab 439,00 €	95.5

Goal

Intuitive

Interactive

Multi-Attribute



Ranking Visualization

To Create

Refine



















Explore

Rank	University	Score
------	------------	-------

1. MIT, USA 
2. Harvard, U 
3. Princeton, 
4. Cambridge 
5. Oxford, UK  4.0

Support Multiple Attributes

$$\text{Score} = f(A, B, C)$$

Rank	University	A	B	C
1.	MIT, USA			
2.	Harvard, USA		 	
3.	Princeton, US		 	
4.	Cambridge, U		 	
5.	Oxford, UK			

Combiner functions: $f(A,B,C)$

(Weighted) sum

$$\text{Score} = w_a A + w_b B + w_c C$$

→ Serial

Maximum

$$\text{Score} = \max(A, B, C)$$

→ Parallel

Product

Nesting

...

→ Complex
Combiners

Serial Combiner (as Stacked Bar)



Rank	University	A	B	C
1.	MIT, USA			
2.	Harvard, USA			
3.	Princeton, USA			
4.	Cambridge, UK			
5.	Oxford, UK			

Serial Combiner (as Stacked Bar)



Rank	University	A	B	C
1.	MIT, USA			
2.	Harvard, USA			
3.	Princeton, USA			
4.	Cambridge, UK			
5.	Oxford, UK			

Serial Combiner (as Stacked Bar)



Rank	University	A	B	C
1.	MIT, USA	Large red segment	Medium green segment	Medium purple segment
2.	Harvard, USA	Large red segment	Medium green segment	Medium purple segment
3.	Princeton, USA	Medium red segment	Medium green segment	Medium purple segment
4.	Cambridge, UK	Large red segment	Small green segment	Small purple segment
5.	Oxford, UK	Large red segment	Very small green segment	Small purple segment

Rank	School Name	Country	Faculty/student ratio	Employer reputation	Citations per faculty
	Filter: <None>	Filter: 2 out of 72			
1.	American University	United States			
2.	Arizona State University	United States			
3.	Aston University	United Kingdom			
4.	Birkbeck College, University of L	United Kingdom			
5.	Boston College	United States			
6.	Boston University	United States			
7.	Brandeis University	United States			
8.	Brown University	United States			
9.	Brunel University	United Kingdom			
10.	California Institute of Technology	United States			
11.	Cardiff University	United Kingdom			
12.	Case Western Reserve University	United States			
13.	City University London	United Kingdom			
14.	College of William & Mary	United States			
15.	Colorado State University	United States			
16.	Columbia University	United States			
17.	Cornell University	United States			
18.	Cranfield University	United Kingdom			
19.	Dartmouth College	United States			
20.	Drexel University	United States			
21.	Duke University	United States			
22.	Durham University	United Kingdom			

*Flexible Mapping of
Attributes to Scores*

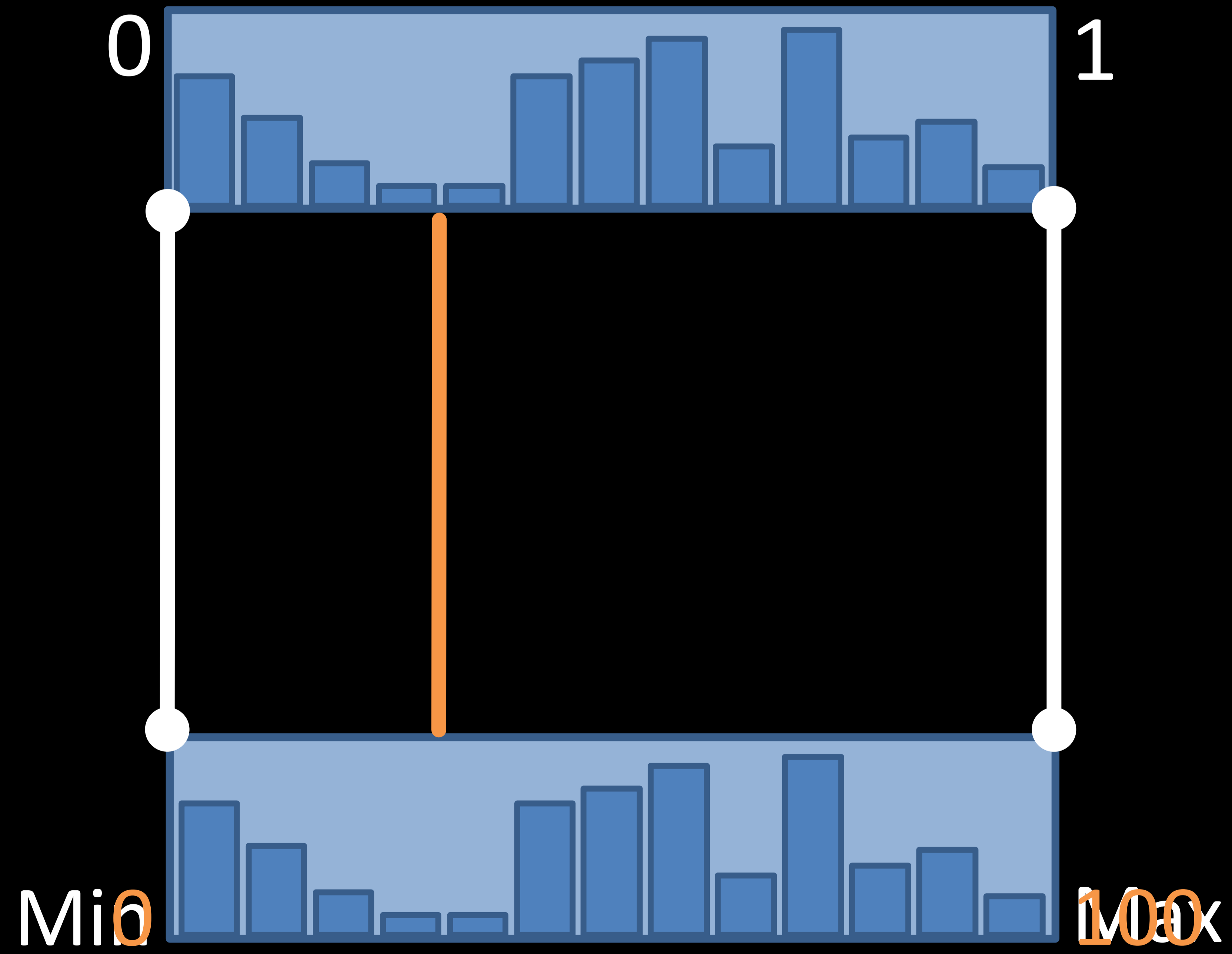
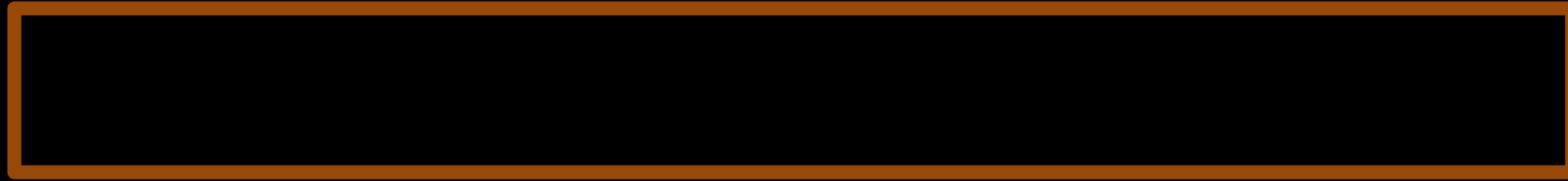

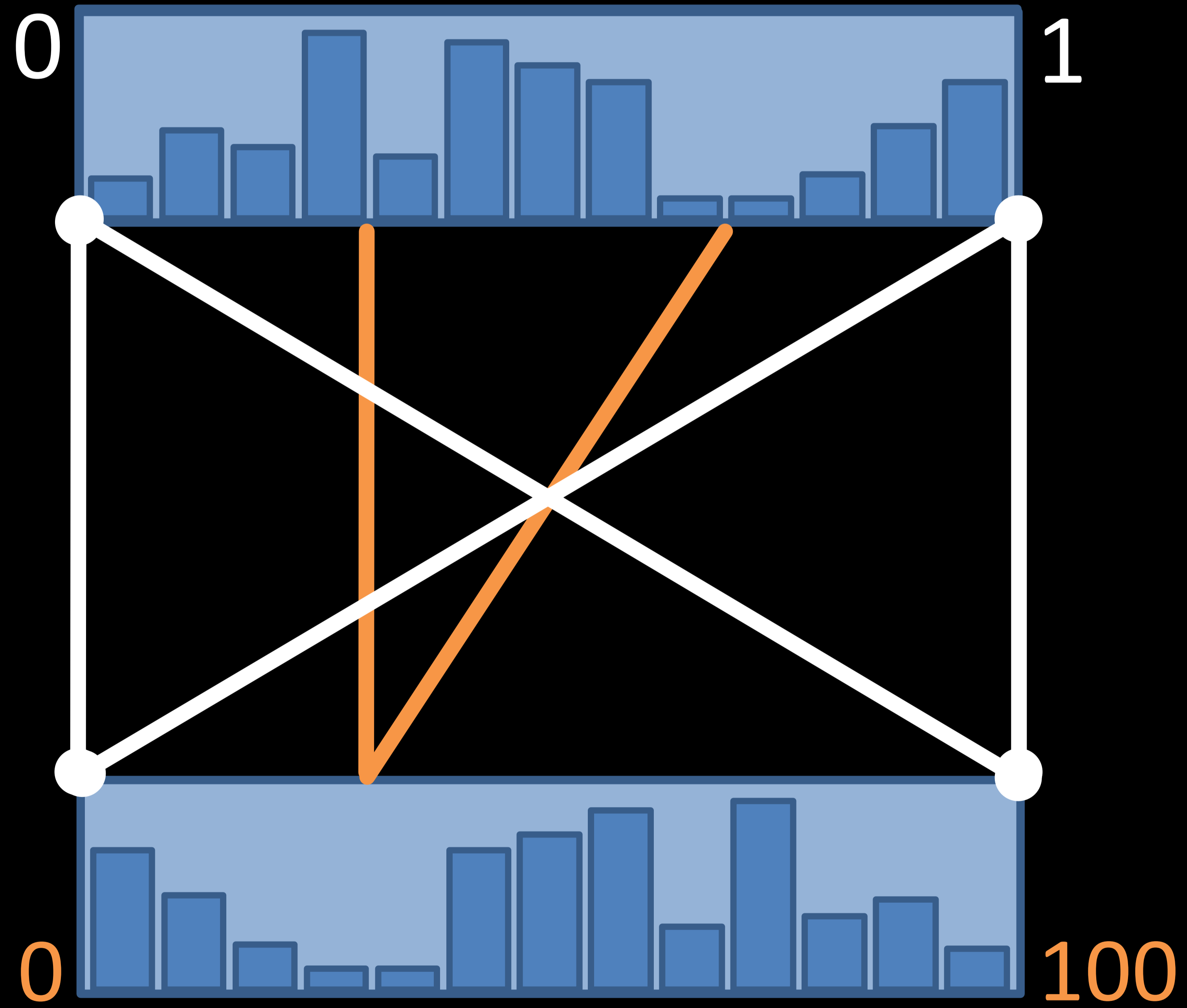
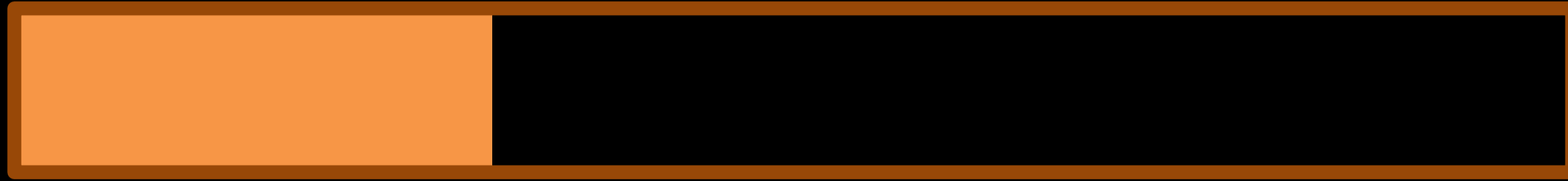

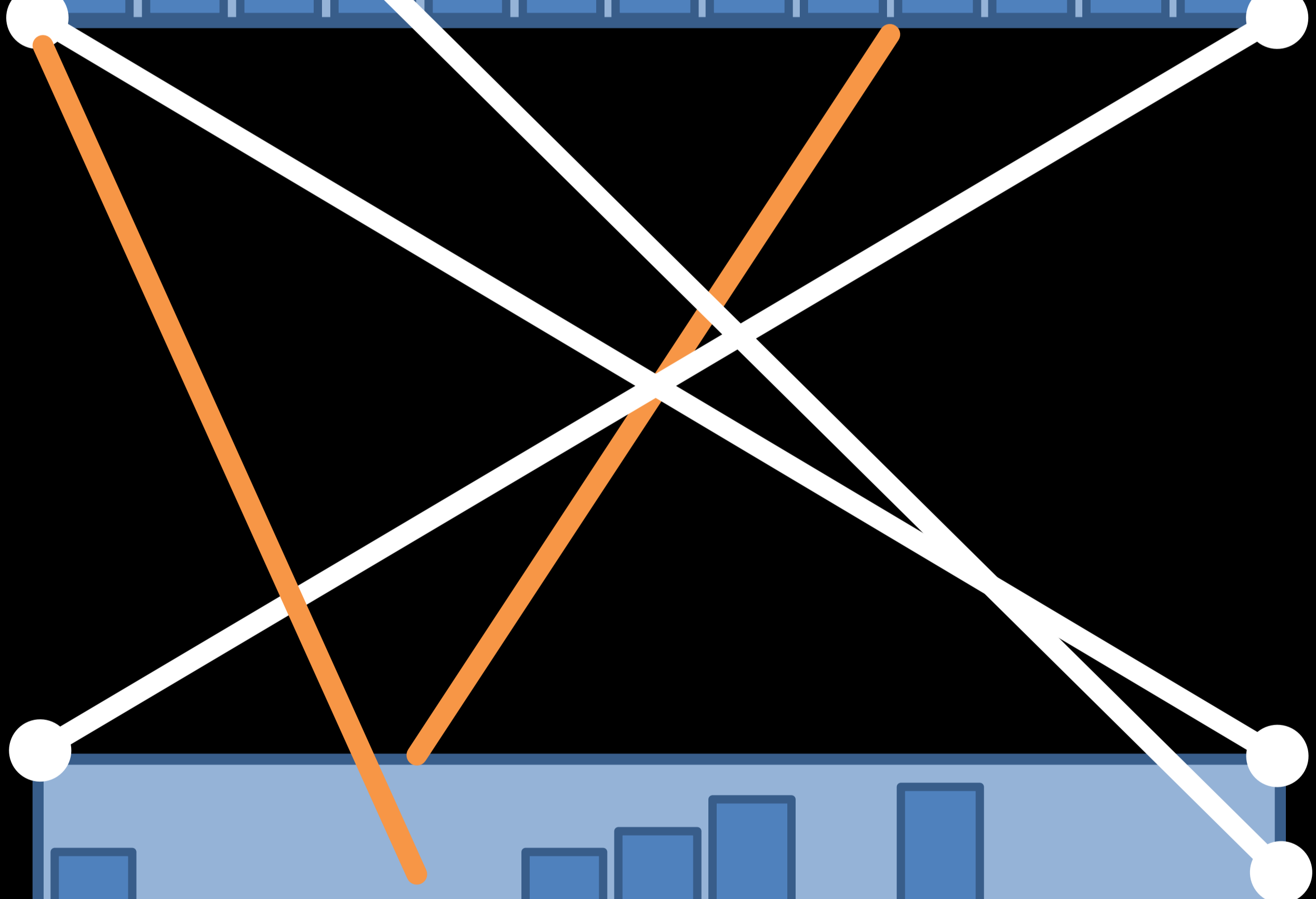
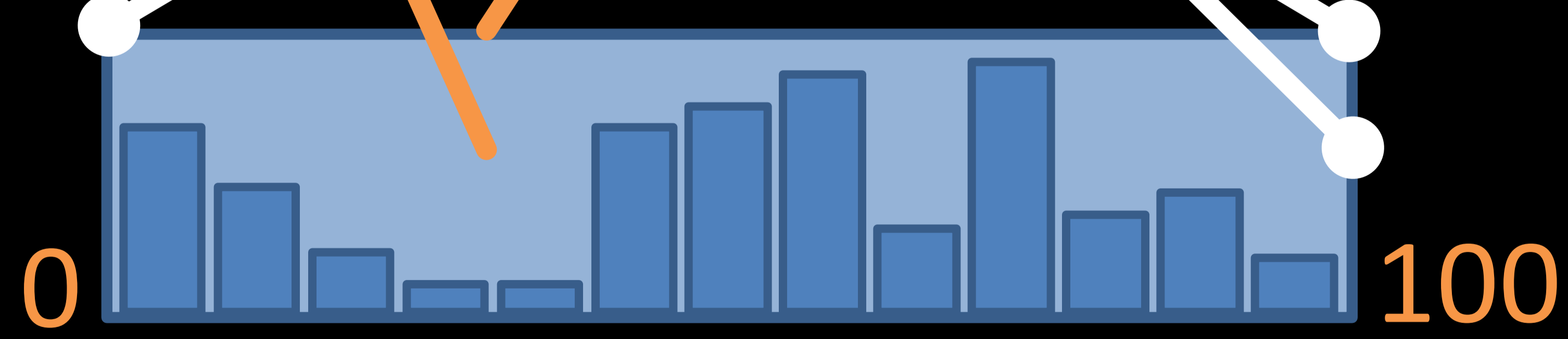
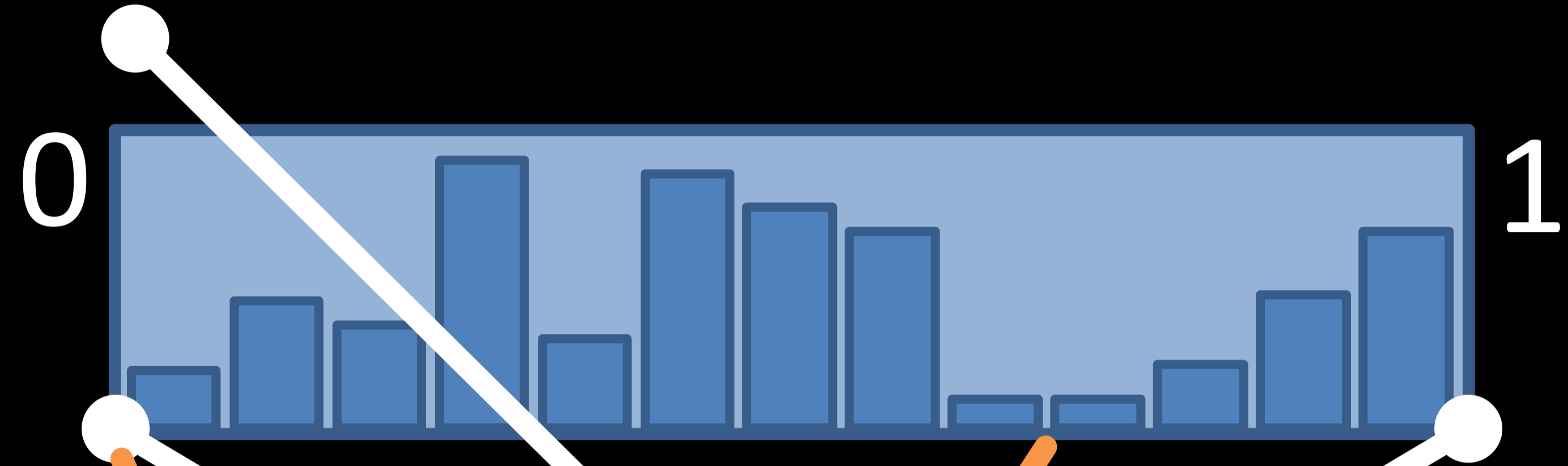

SUM (Engineering & Technology, Arts & Humanities, Life Sciences & Medicine)

Ran	School Name	Country
Filter:		Filter:
<None>		2 out of 43
1.	University of Oxford	United Kingdom
2.	University of Cambridge	United Kingdom
3.	Harvard University	United States
4.	Stanford University	United States
5.	Massachusetts Institute of Technology (MIT)	United States
6.	University of California, Berkeley (UCB)	United States
7.	University of California, Los Angeles (UCL)	United States
8.	Yale University	United States
9.	UCL (University College London)	United Kingdom
10.	Columbia University	United States
11.	Princeton University	United States
12.	University of Edinburgh	United Kingdom
13.	University of Michigan	United States
14.	Cornell University	United States
15.	University of Pennsylvania	United States
16.	The University of Manchester	United Kingdom
17.	Imperial College London	United Kingdom
18.	University of Chicago	United States

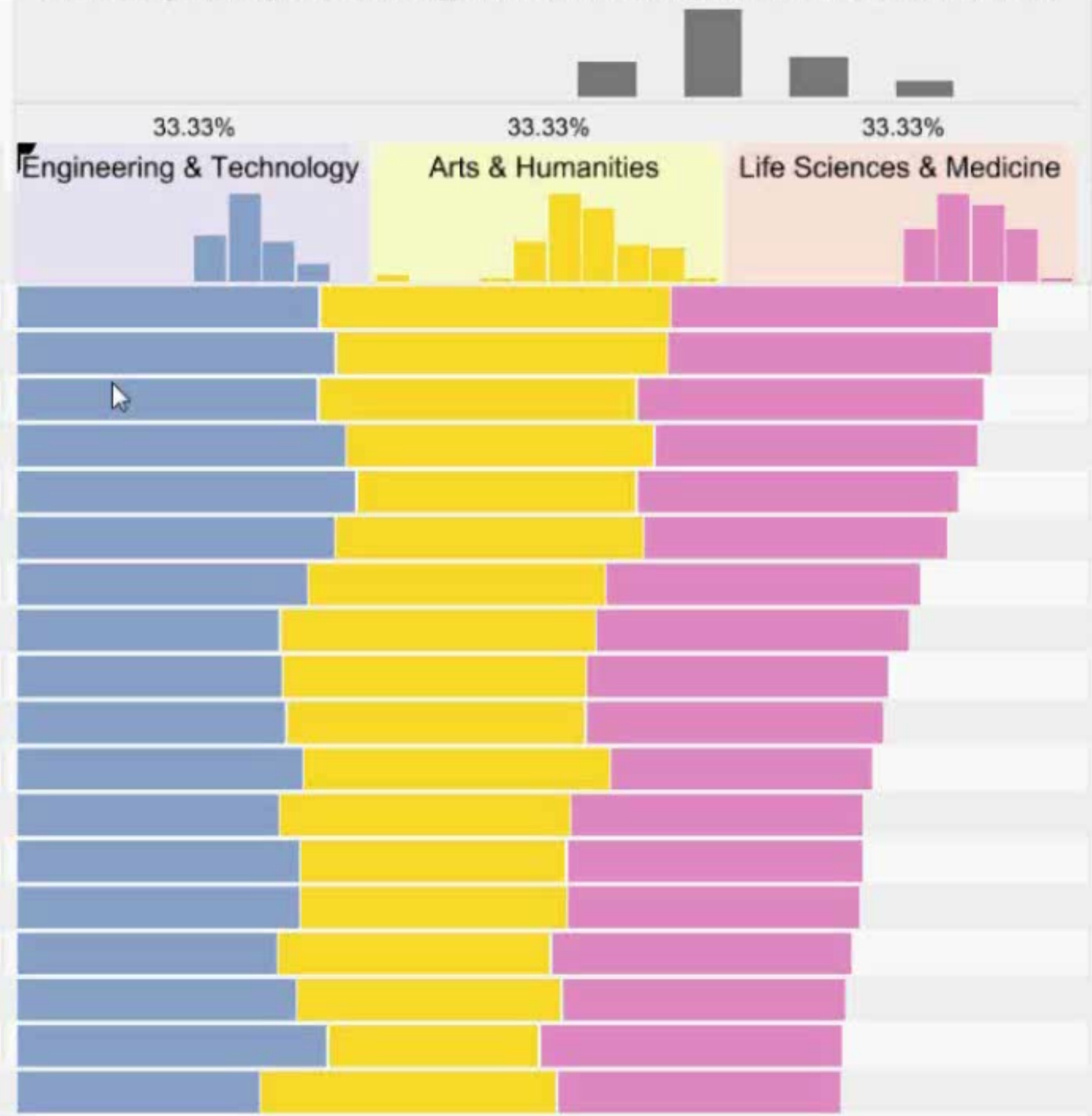

Compare Rankings

Bump Charts

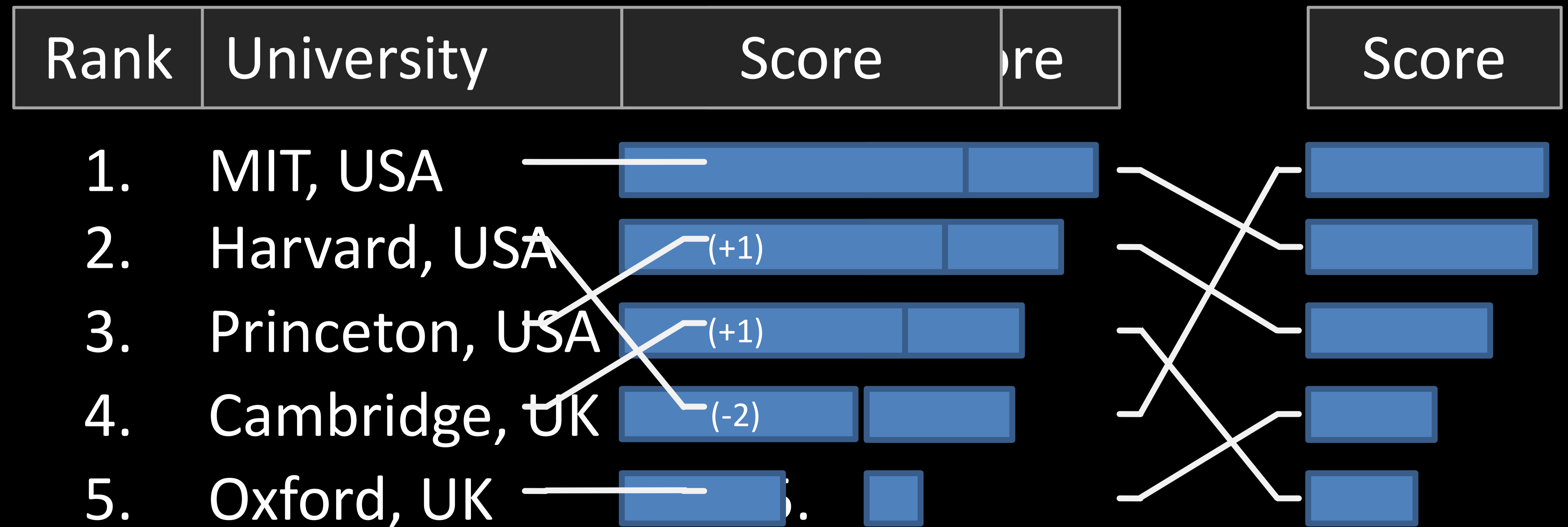

Bump Charts

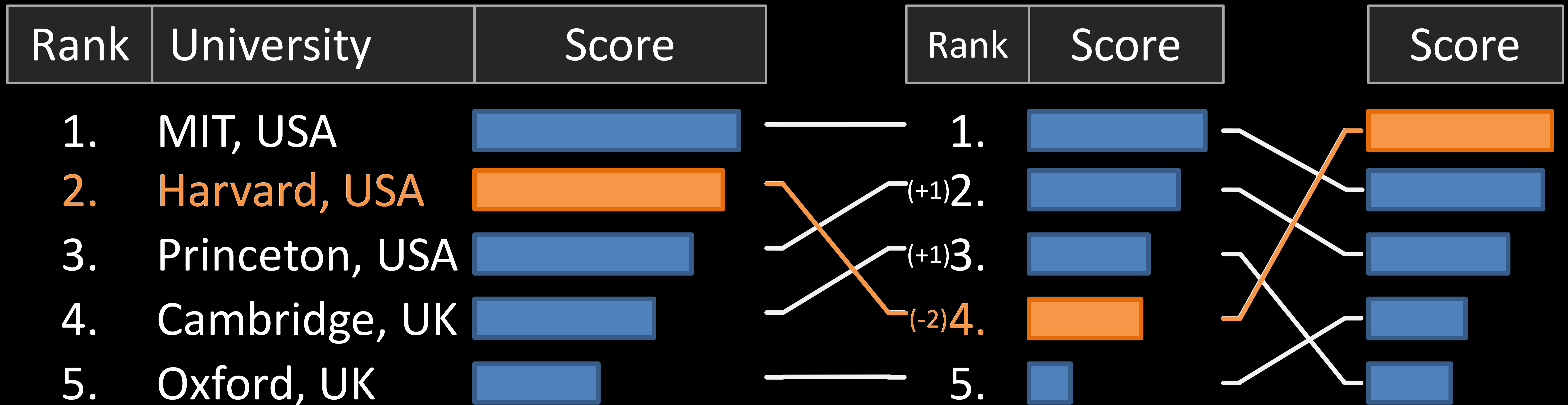

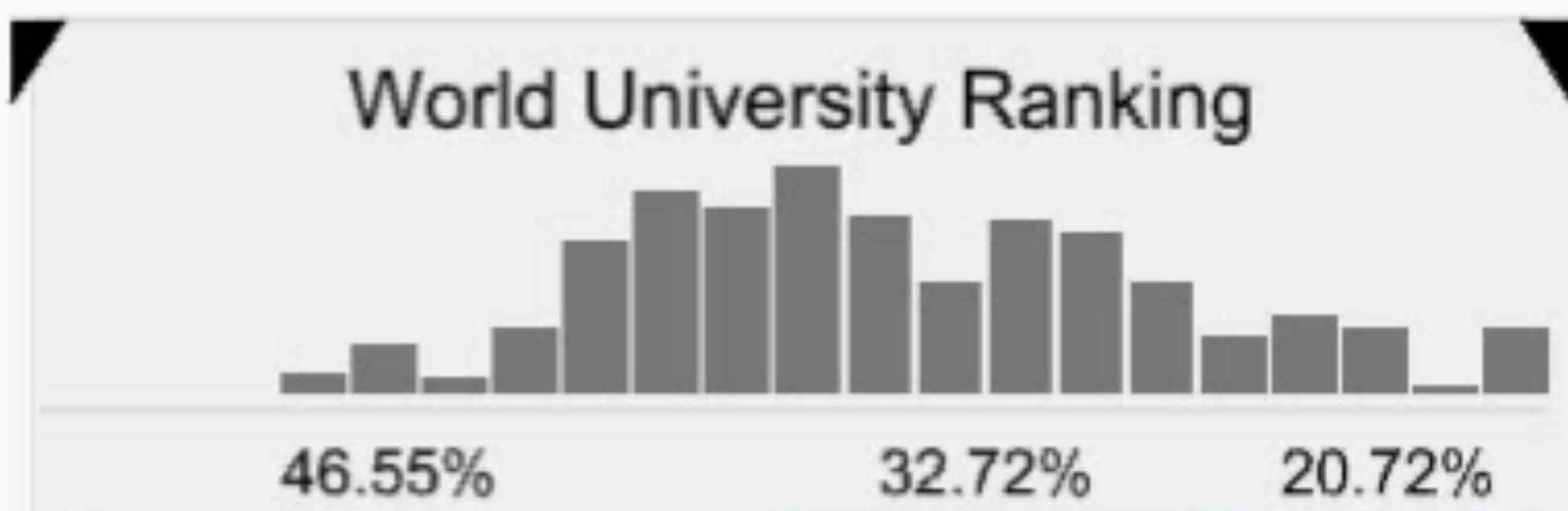

Rank	School Name
	Filter: <None>
1.	Massachusetts Institute of Te
2.	California Institute of Technol
3.	Harvard University
4.	University of Cambridge
5.	UCL (University College Lond
6.	University of Oxford
7.	Princeton University
8.	Imperial College London
9.	University of Chicago
10.	Stanford University
11.	Columbia University
12.	Duke University
13.	University of Pennsylvania
14.	Johns Hopkins University
15.	Yale University
16.	University of Michigan
17.	Ecole normale supérieure, Pa
18.	Northwestern University

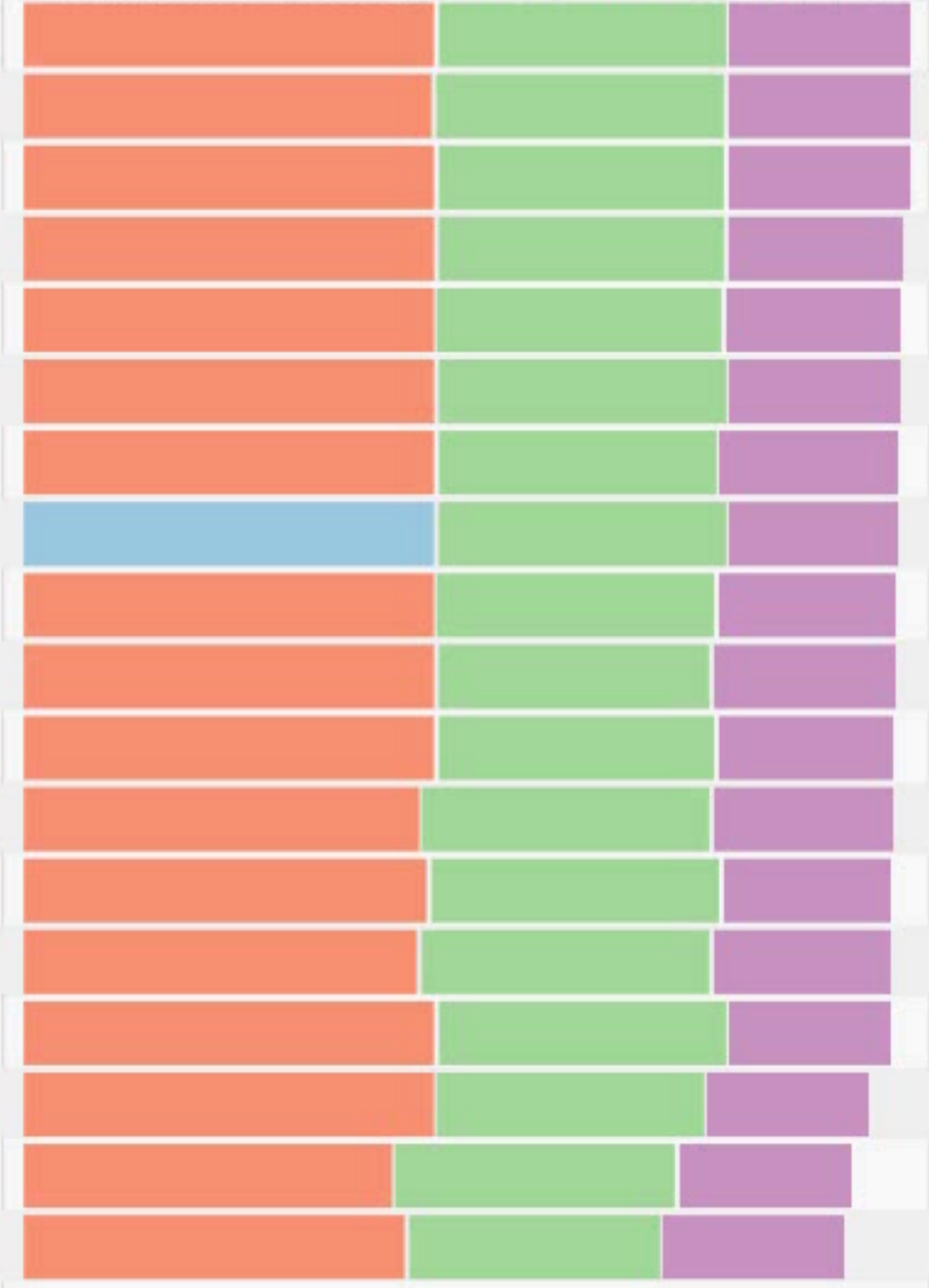

<http://lineup.caleydo.org>
<http://caleydo.github.io/lineup.js/>

[InfoVis'14]

UpSet Visualizing Intersecting Sets

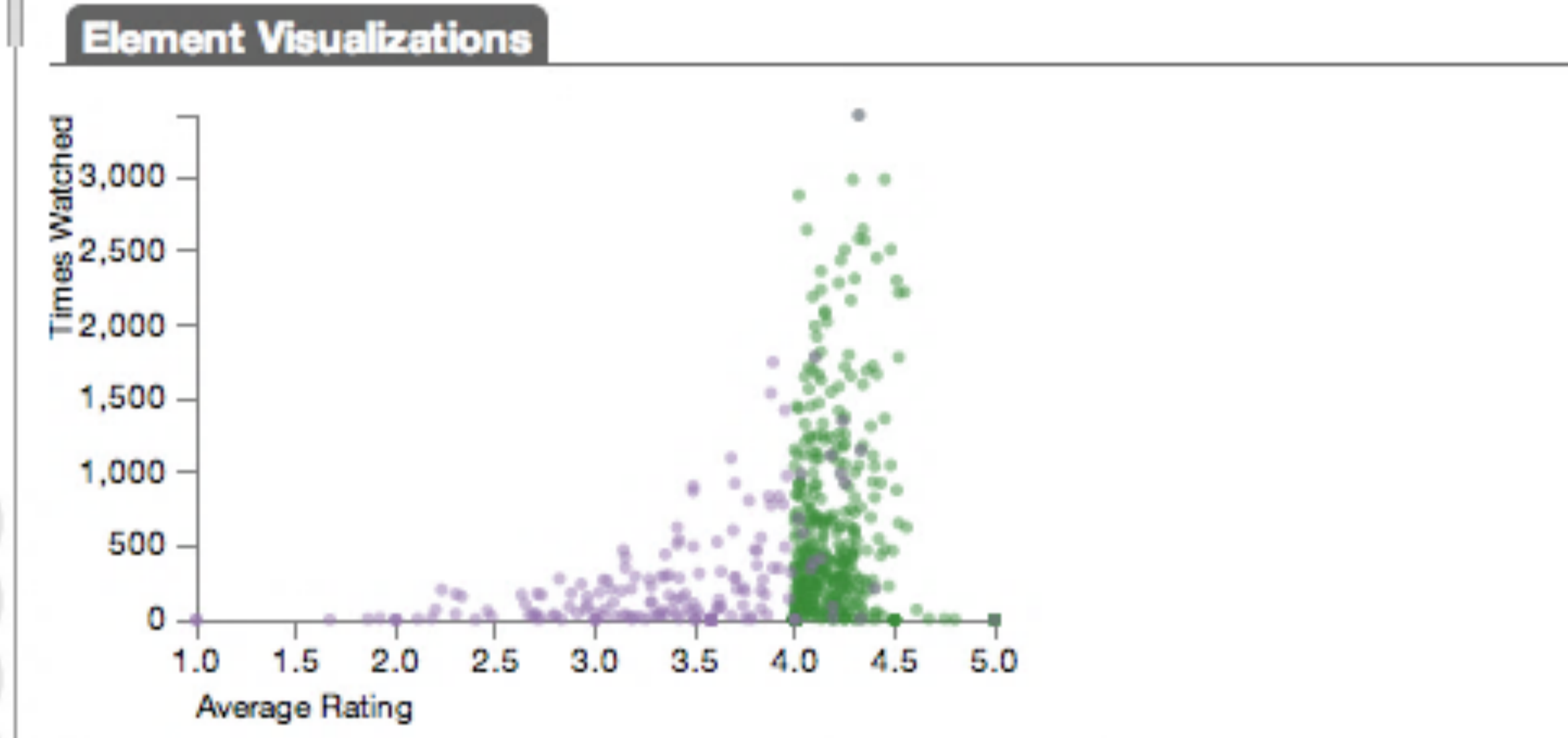
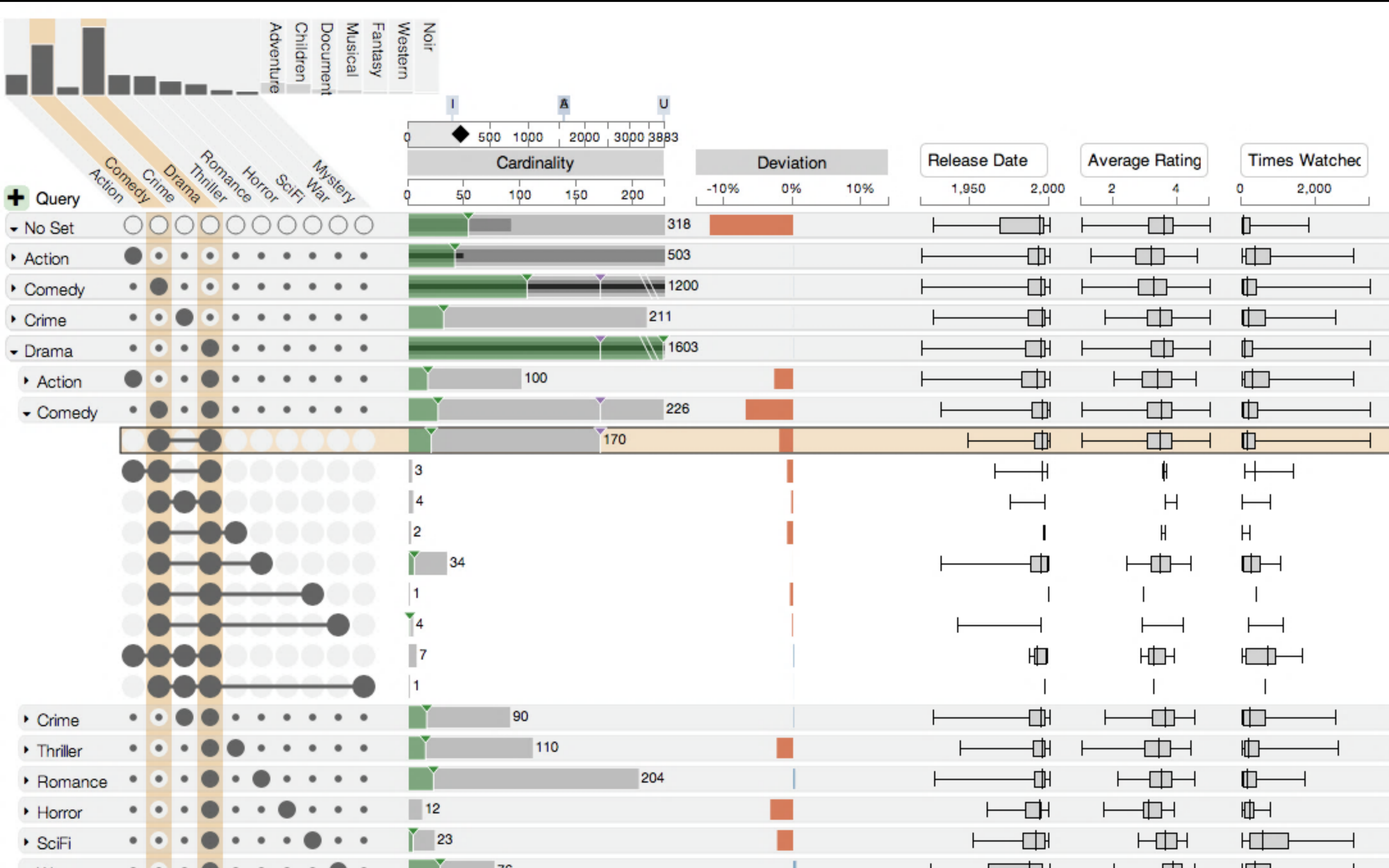

Scatterplot

Element Queries

433 × 170 ×

Query Filters

✖ Range | Average Rating
 Minimum = 4
 Maximum = 5

Name Contains

Query Results

Name	Release Date	Average Rating	Times Watched	Set Count
Toy Story (1995)	1995	4.15	2077	2
Sense and Sensibility (1995)	1995	4.03	835	2
Persuasion (1995)	1995	4.06	179	1
City of Lost Children, The (1995)	1995	4.06	403	2

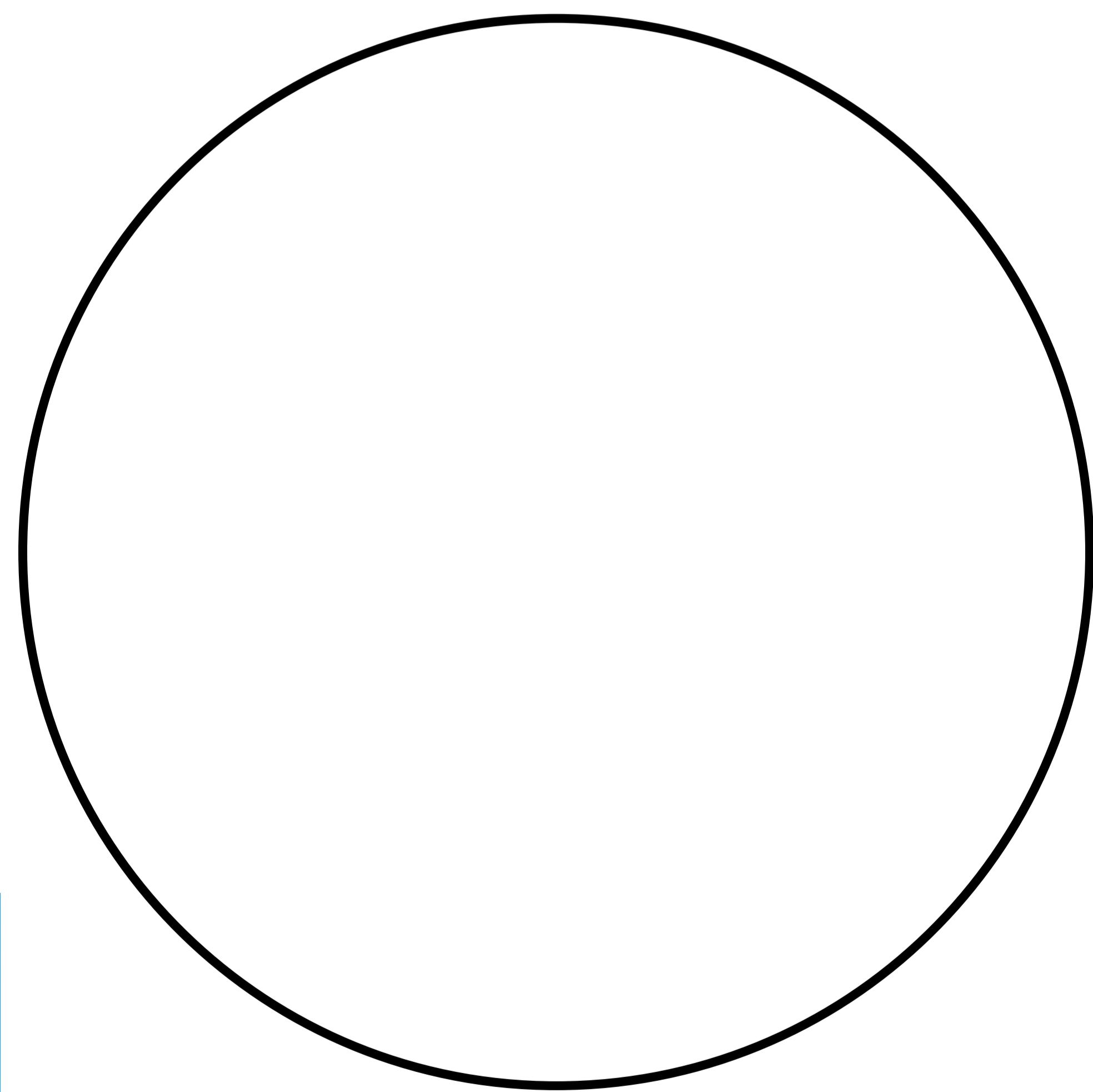

School

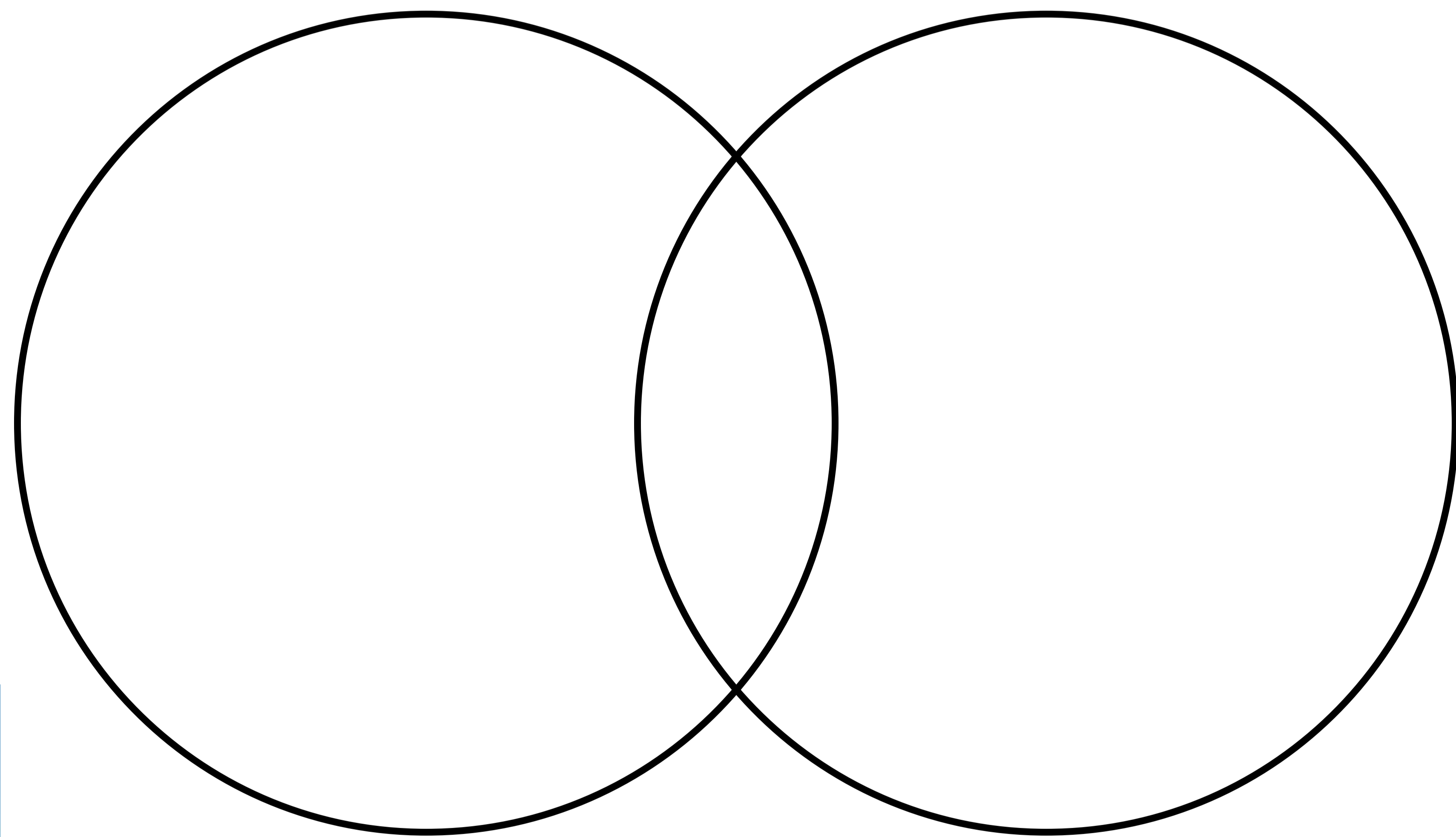

School

Power Plant



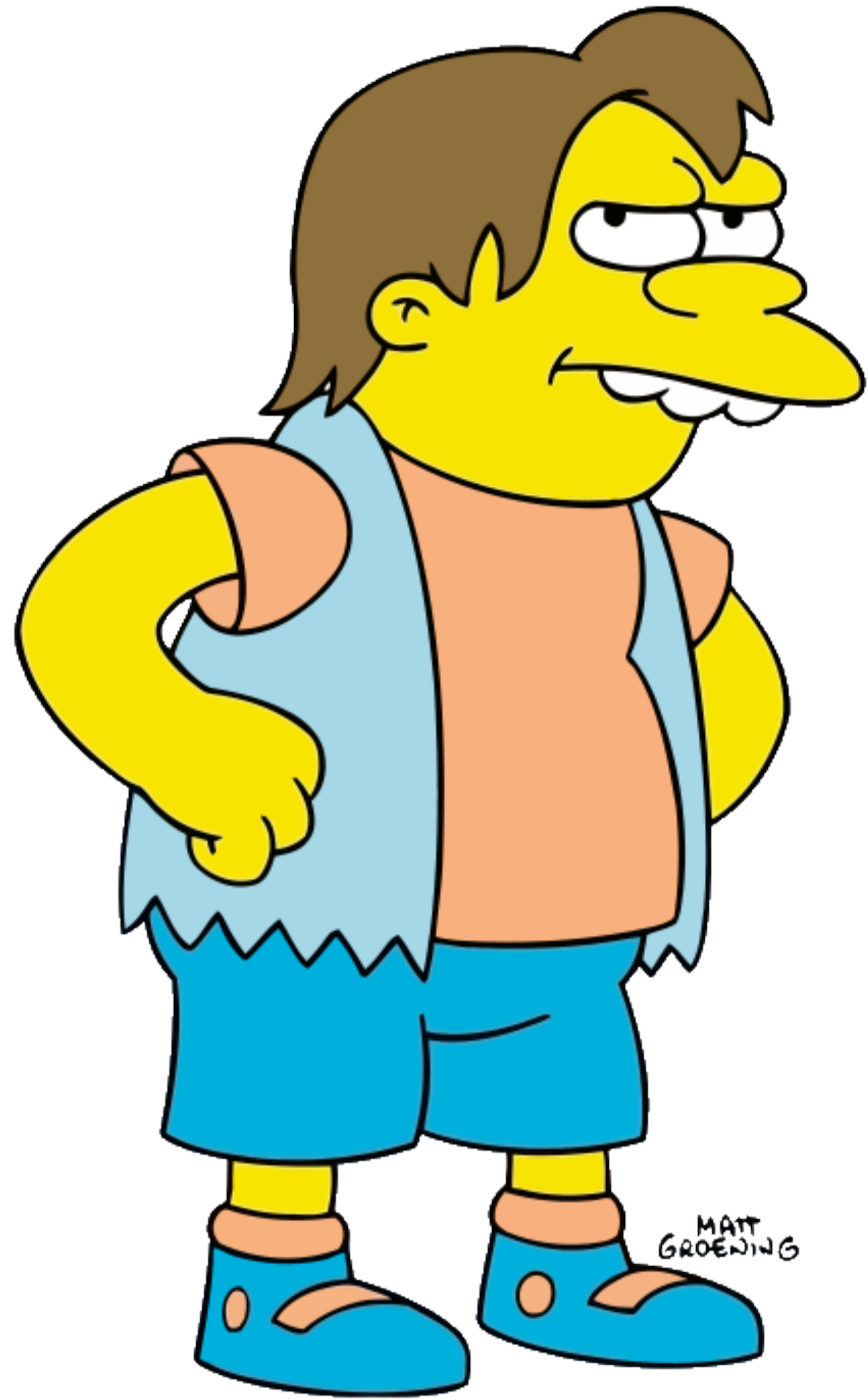

Evil

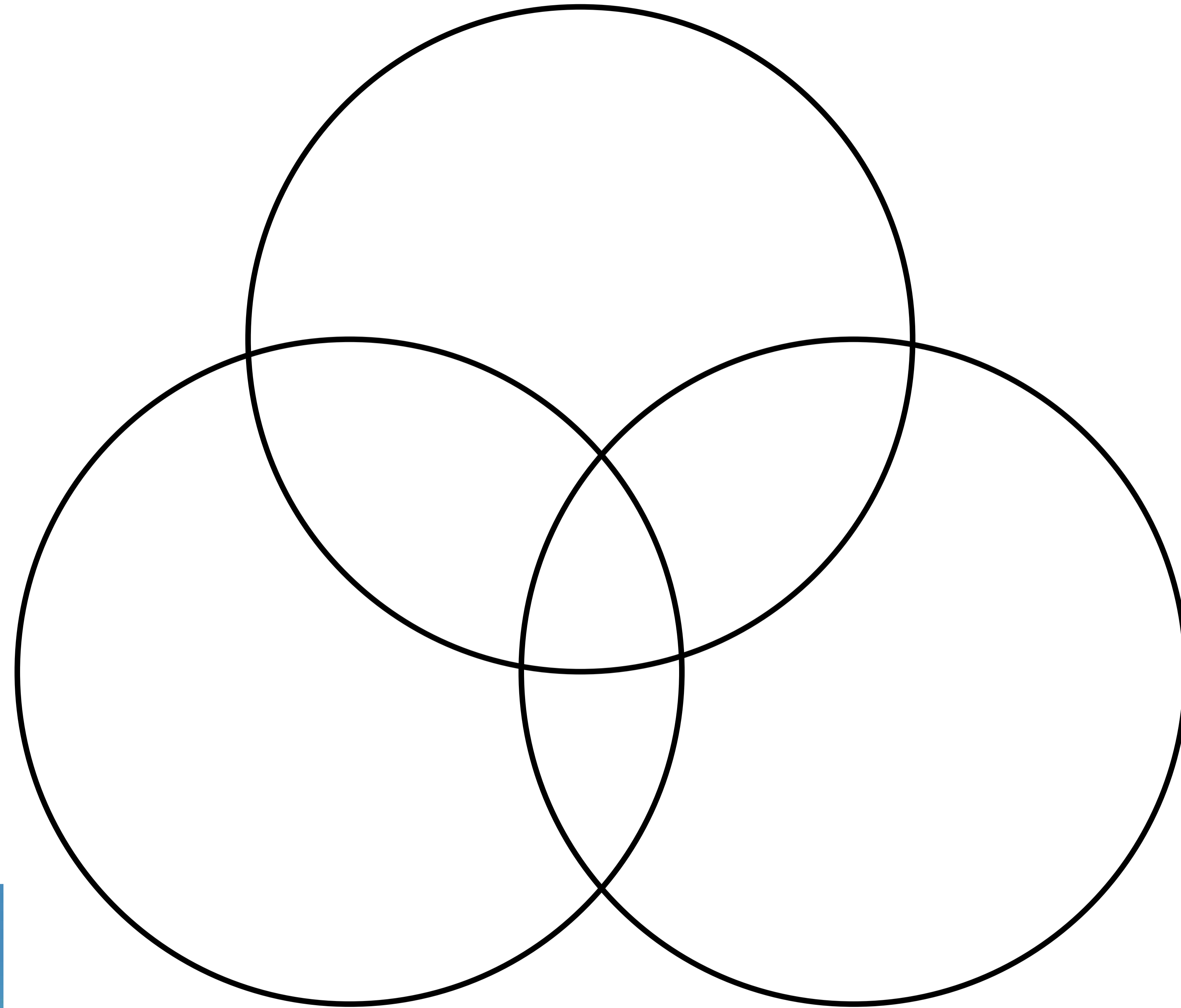

School

Power Plant

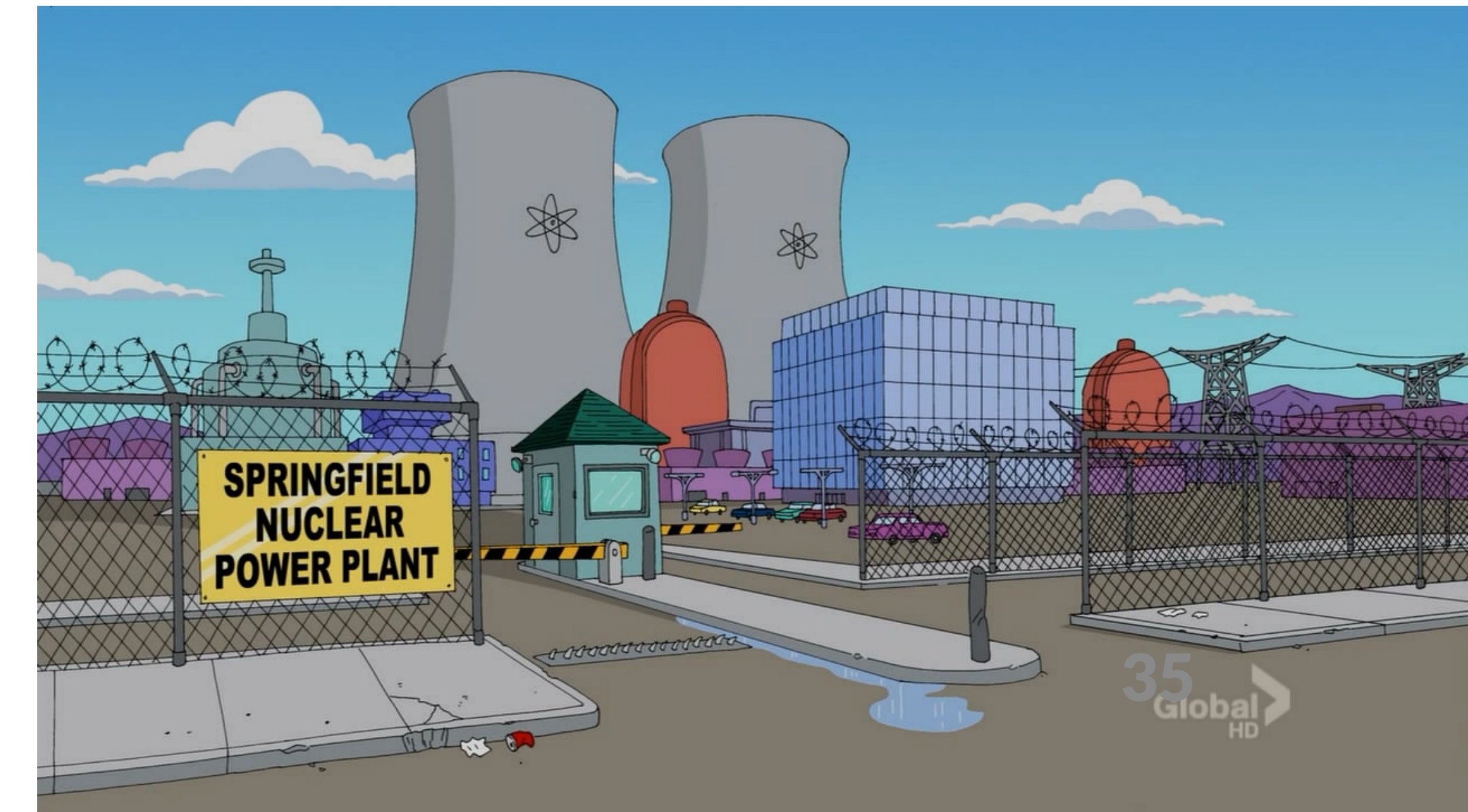

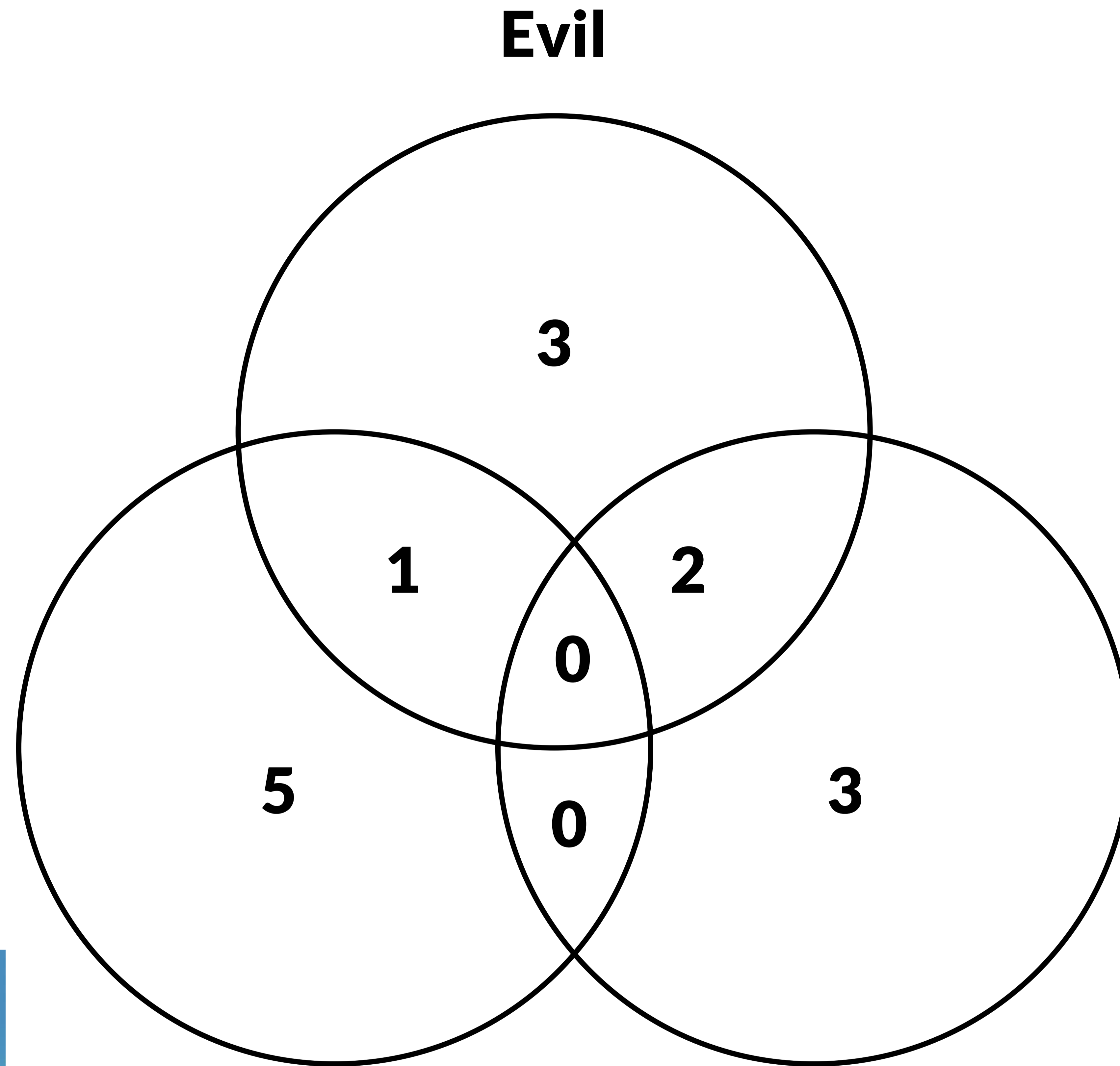



Blue Hair?

Evil

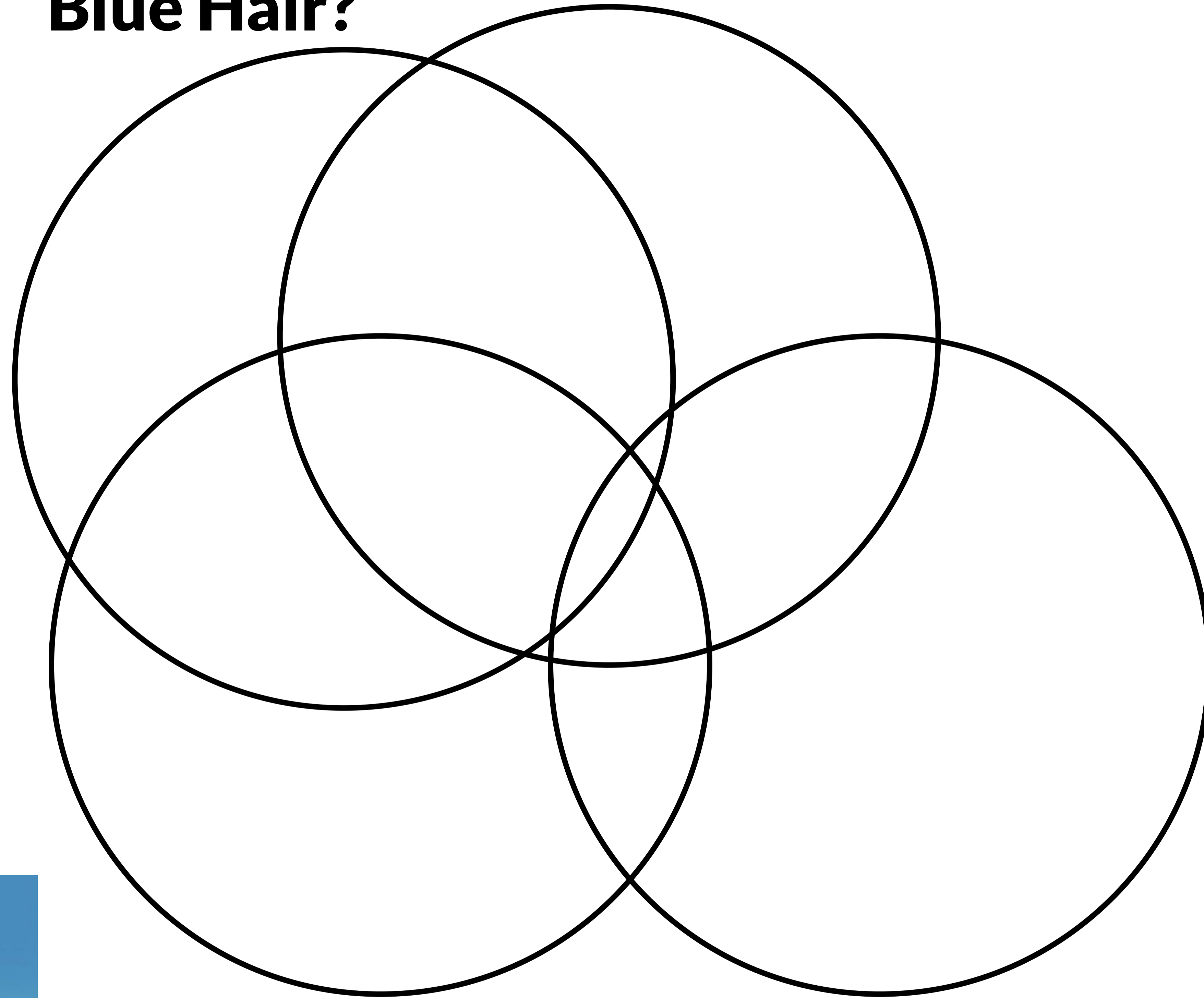

School

Power Plant





Blue Hair?

Evil

Duff Beer?

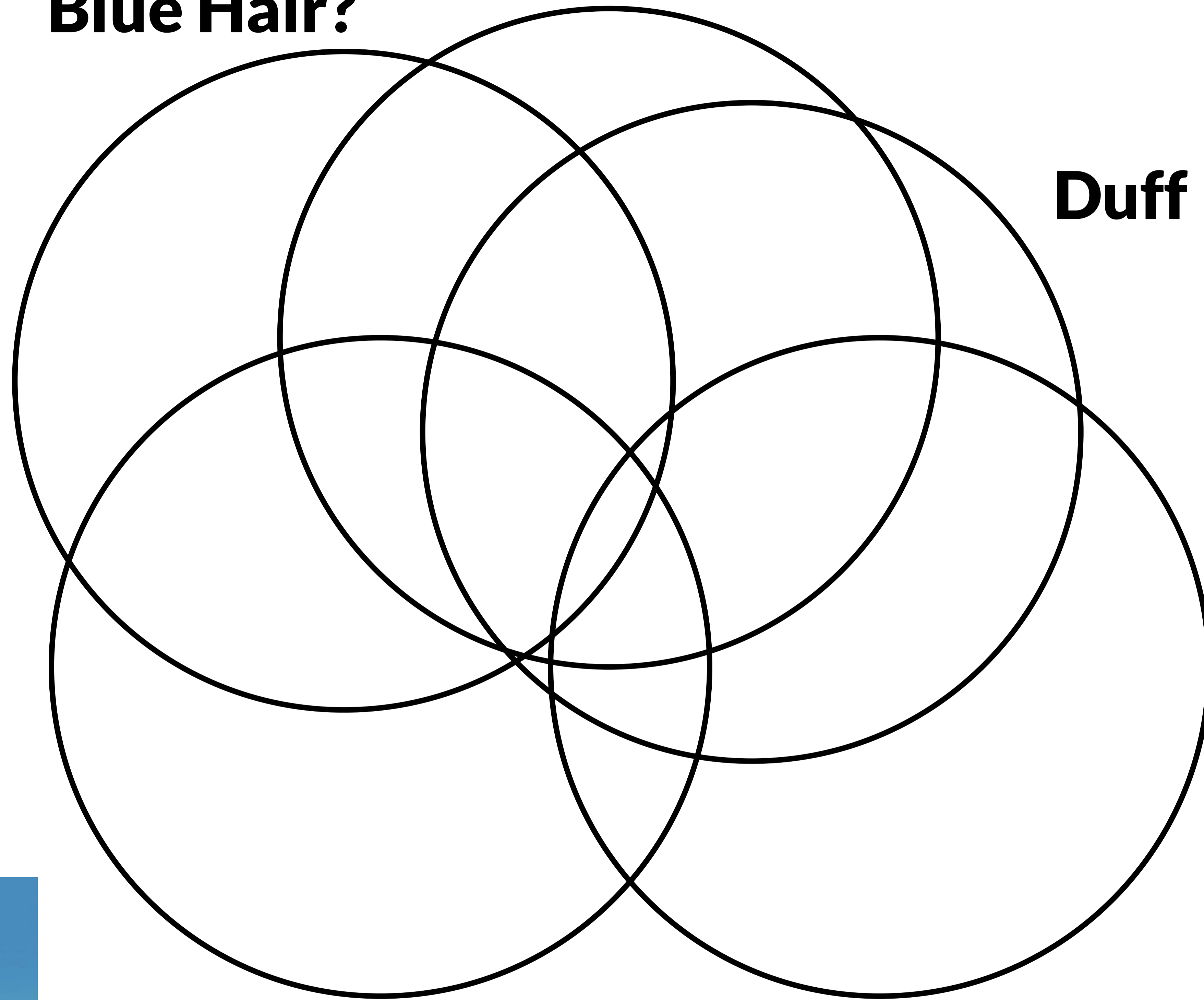

School

Power Plant

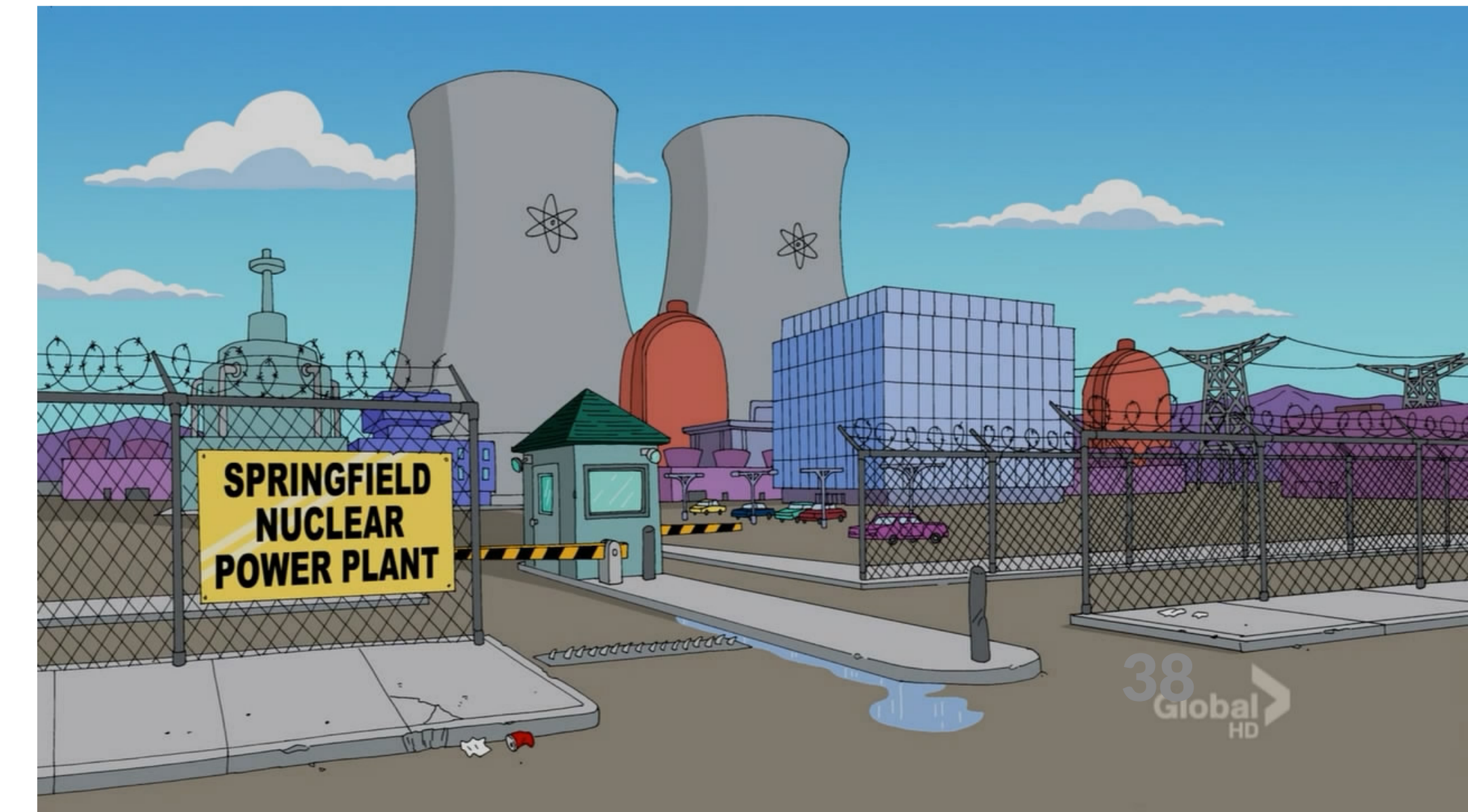

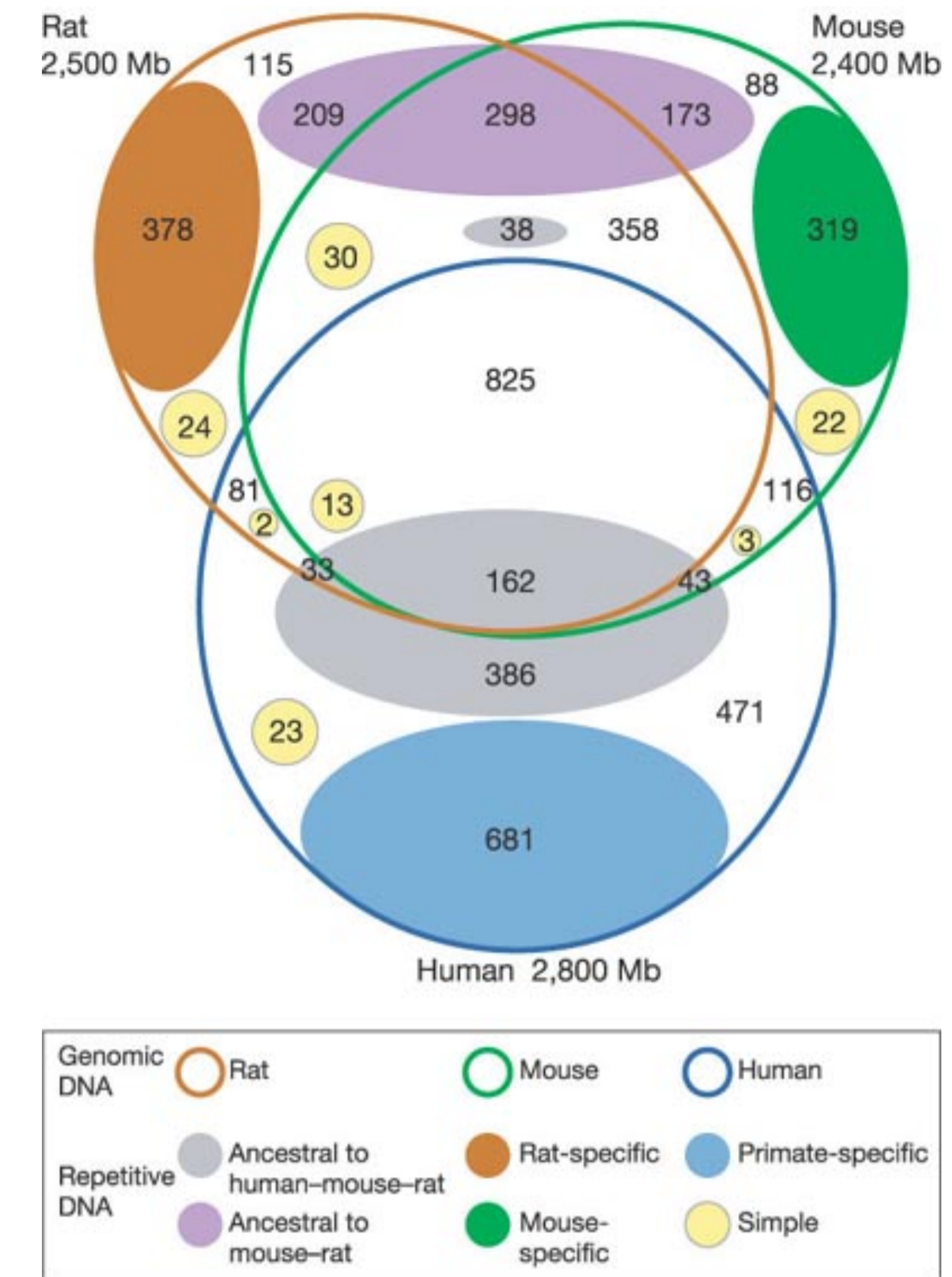
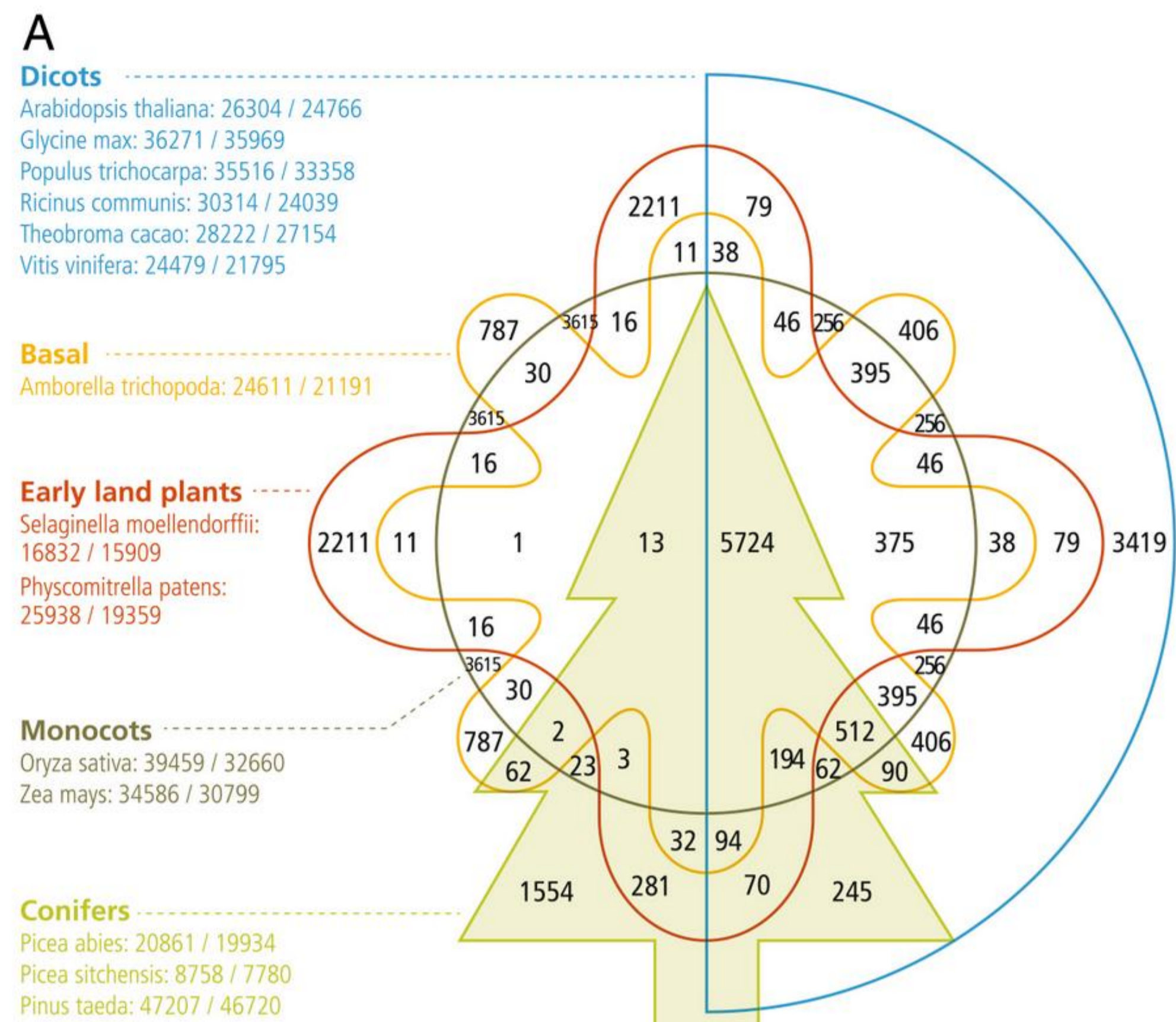

[Gibbs et al., Nature, 2004]

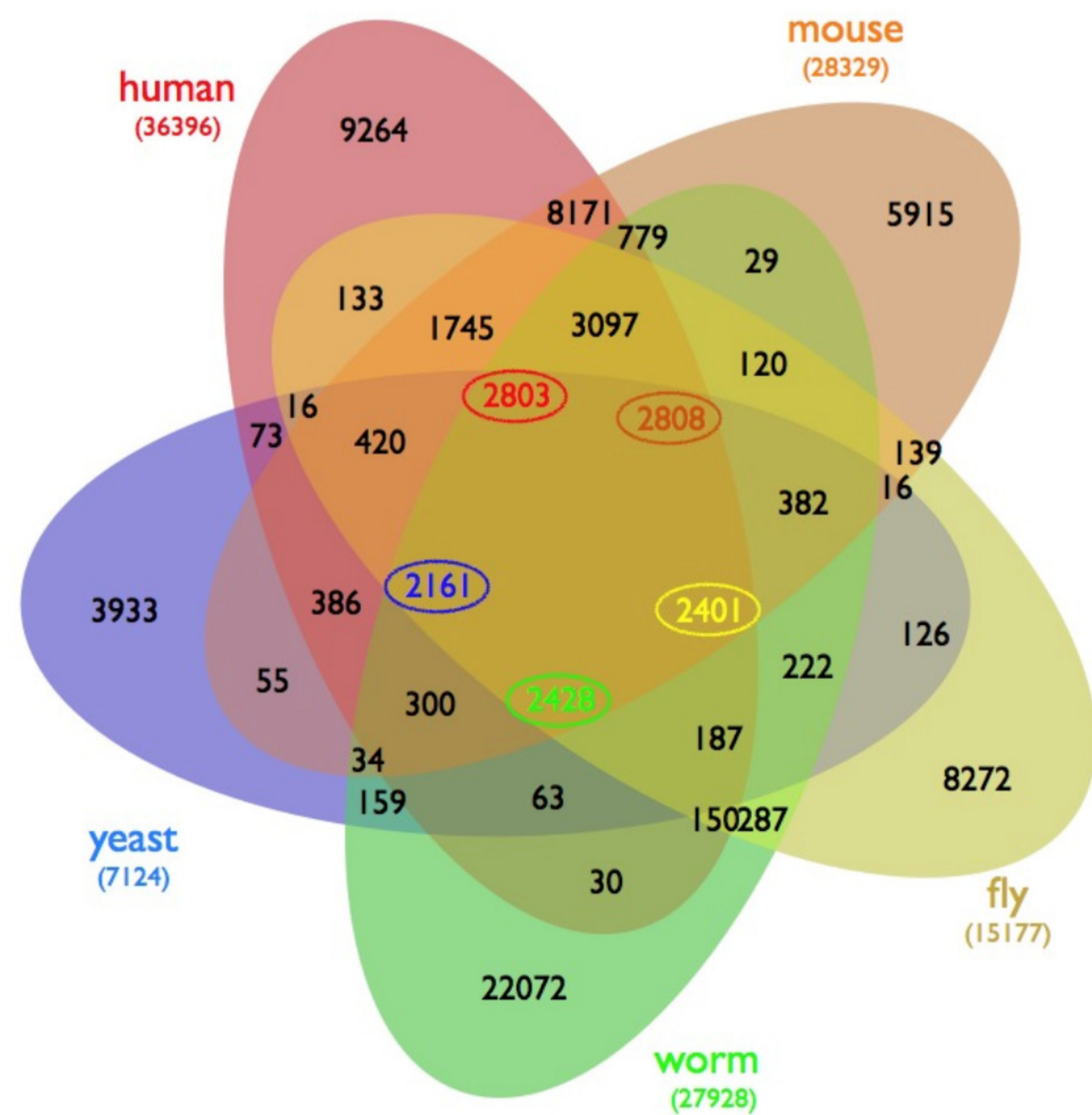

[Wiles et al., BMC Systems Biology]

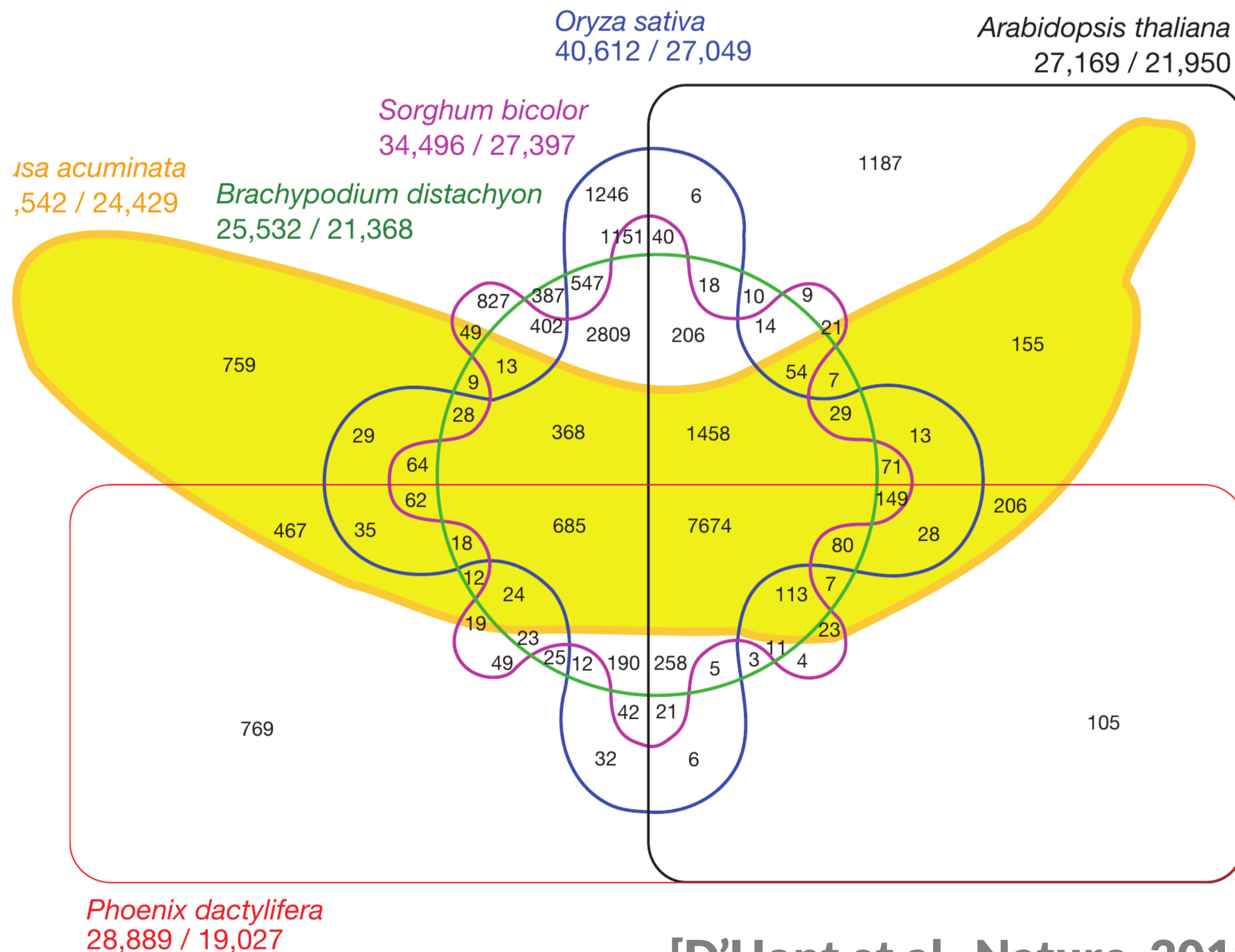

[D'Hont et al., Nature, 2012]

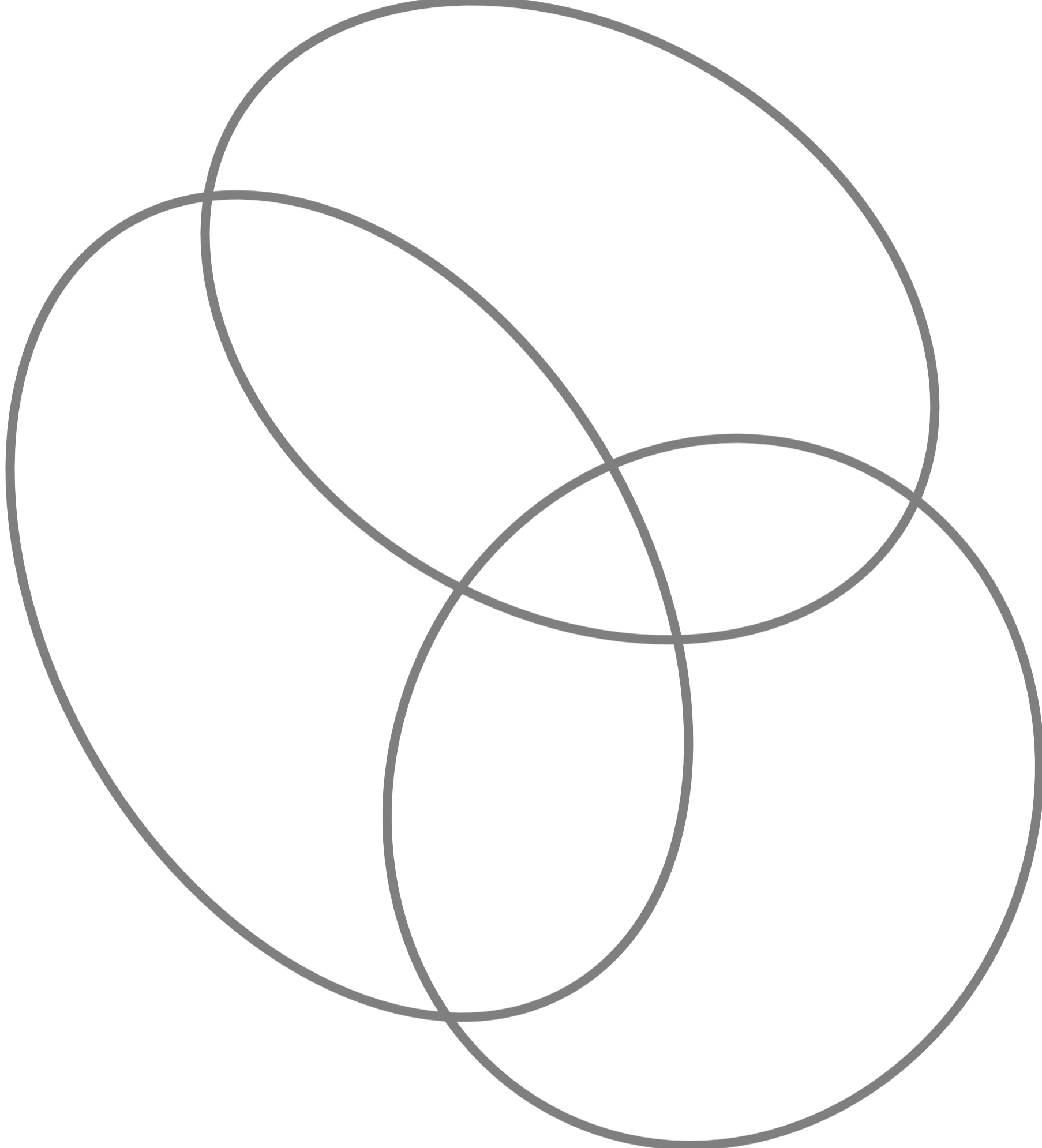

22

AV • ?
AV

19

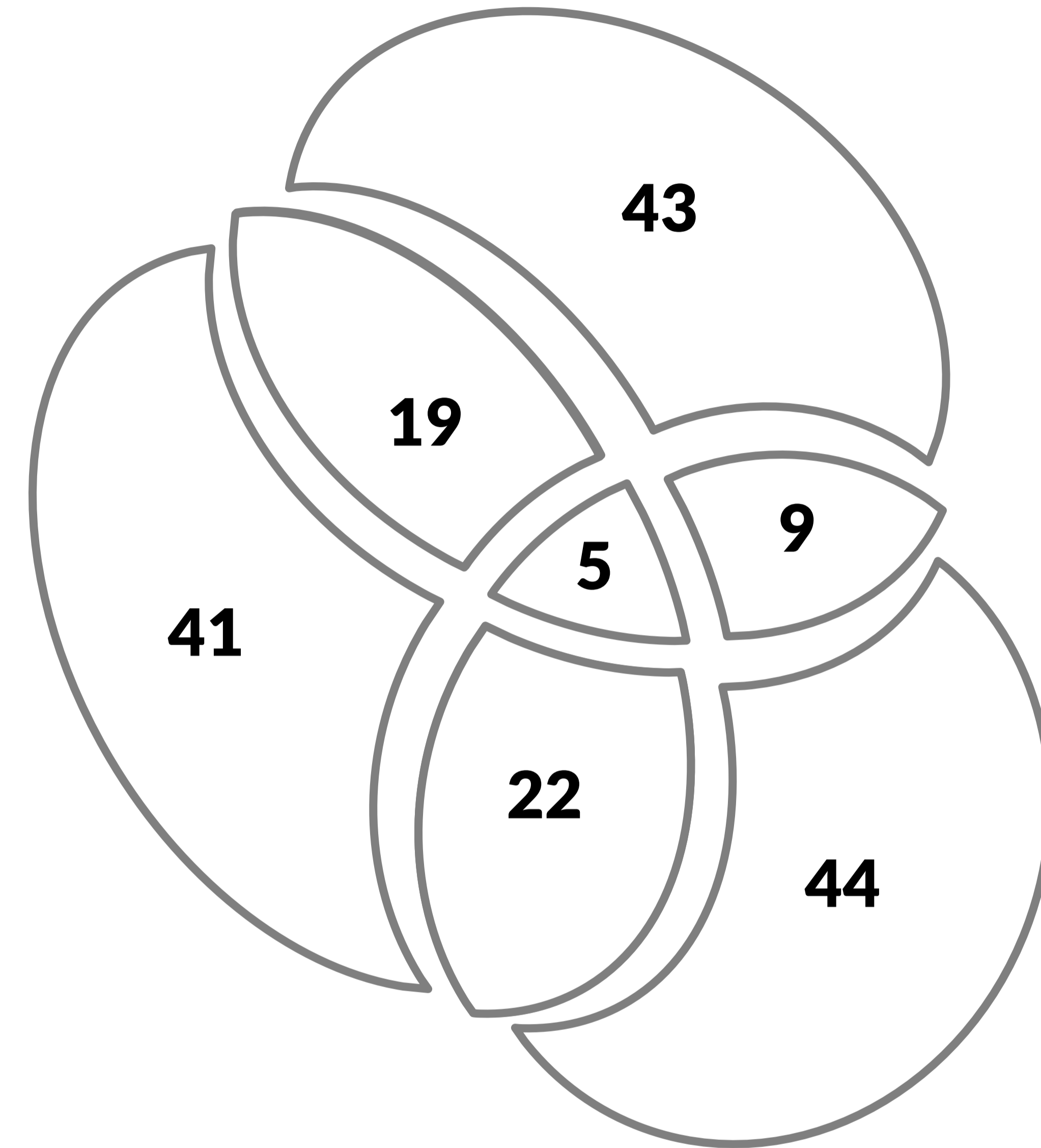

Set Vis Goals

1. Efficient visual encoding

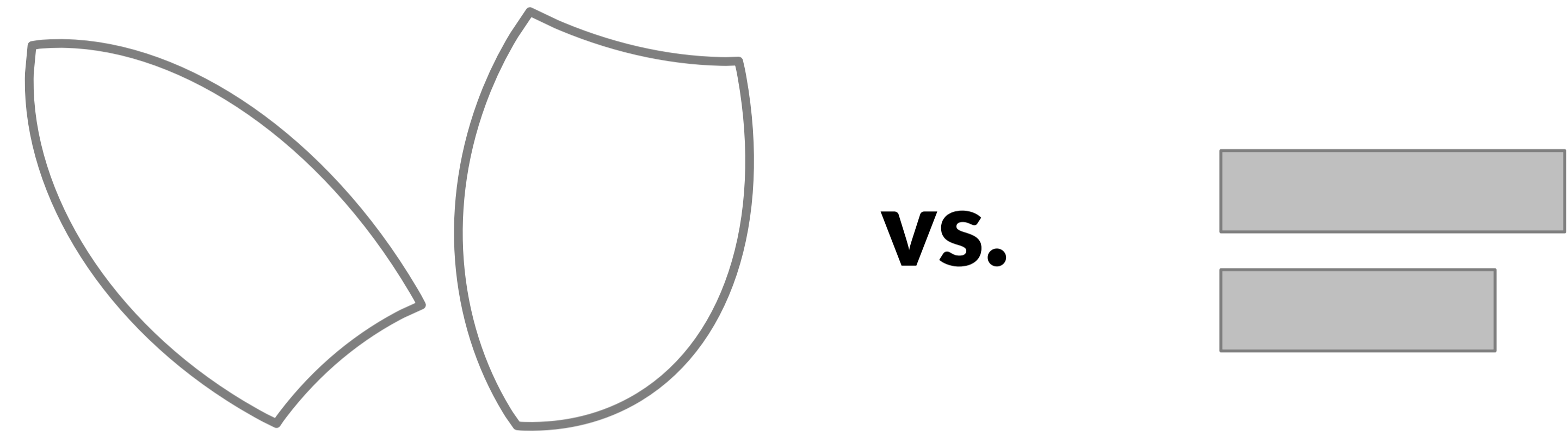

2. Creating complex slices of a dataset

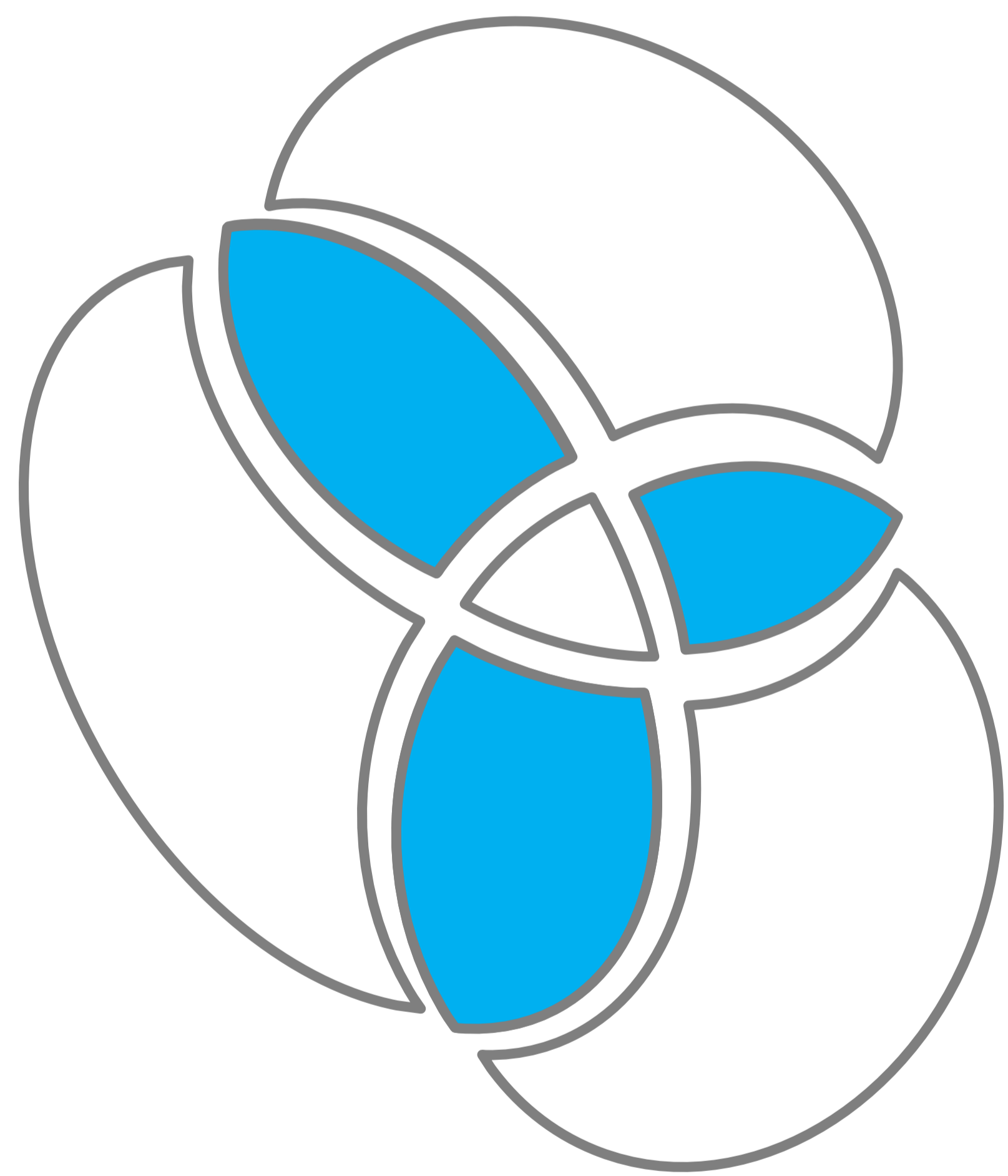

3. Visualize attributes

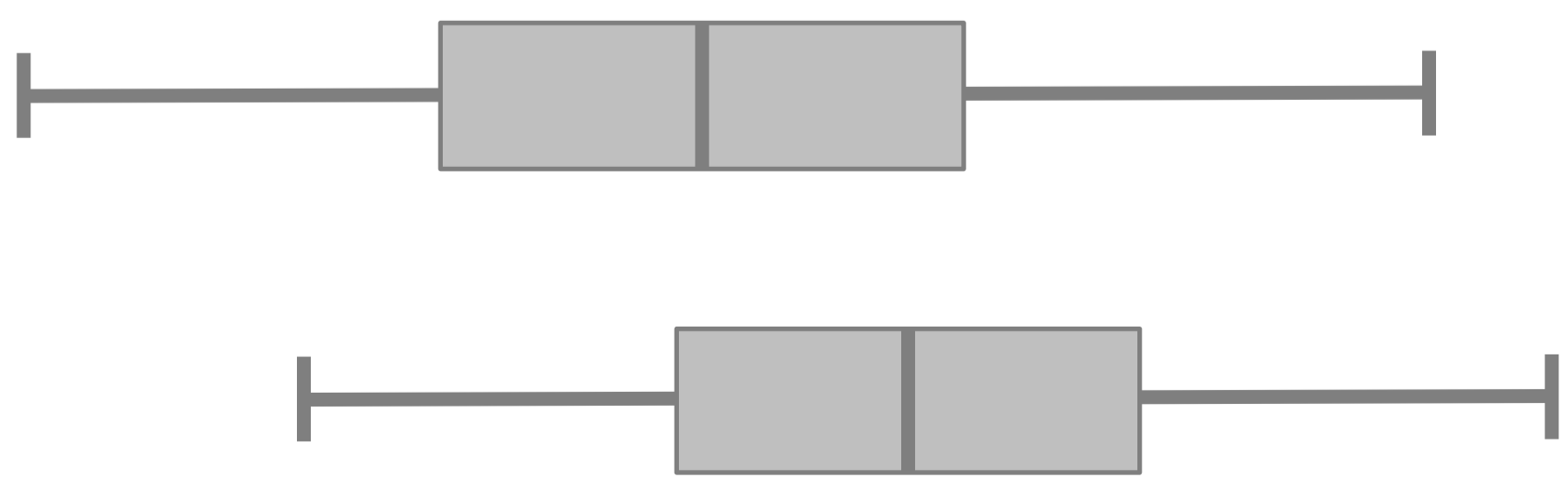

[Movie Lens Dataset]



Attribute Details

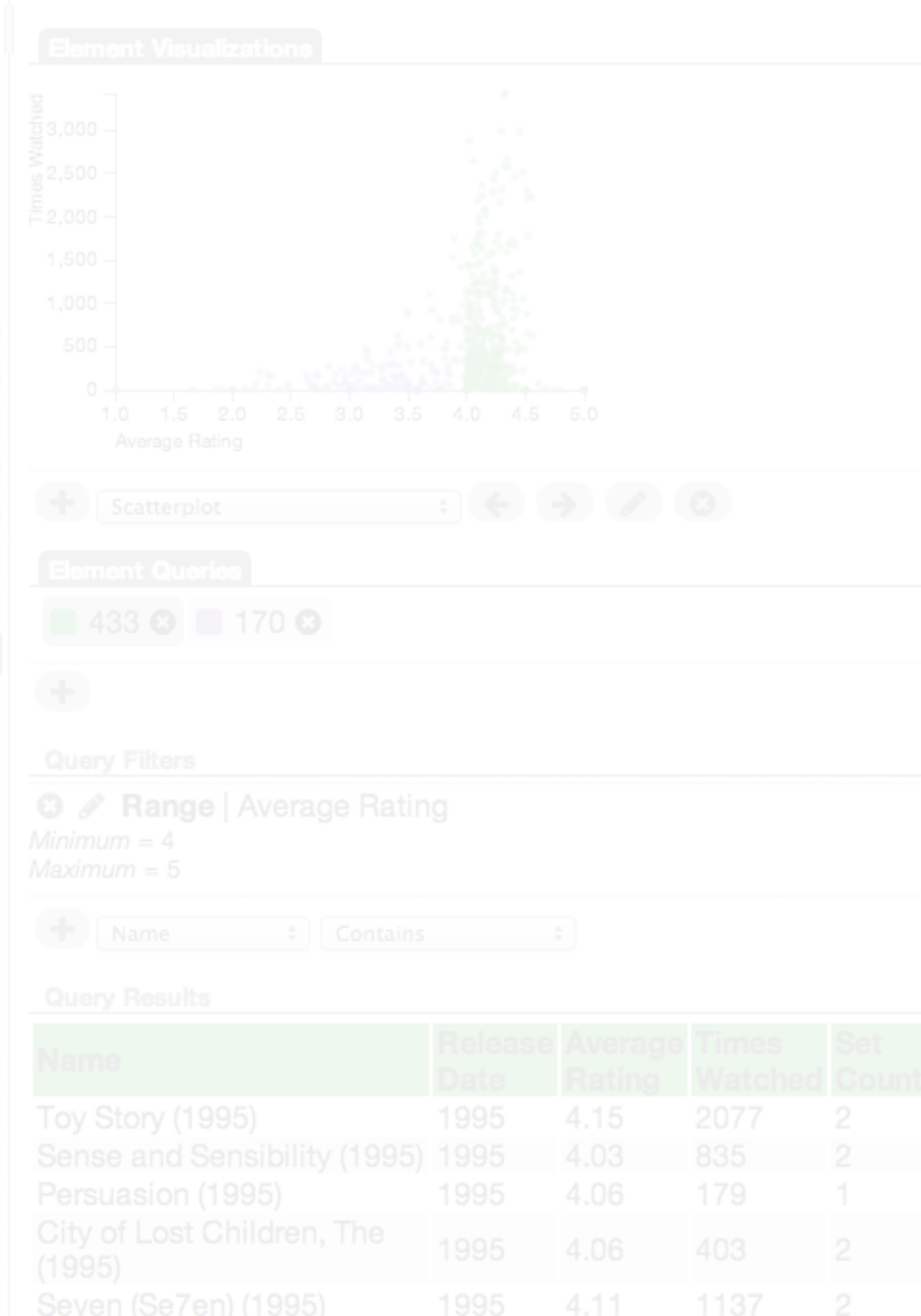

Visualizing Intersections

Visualizing Properties

Element List & Queries

Visualizing Intersections

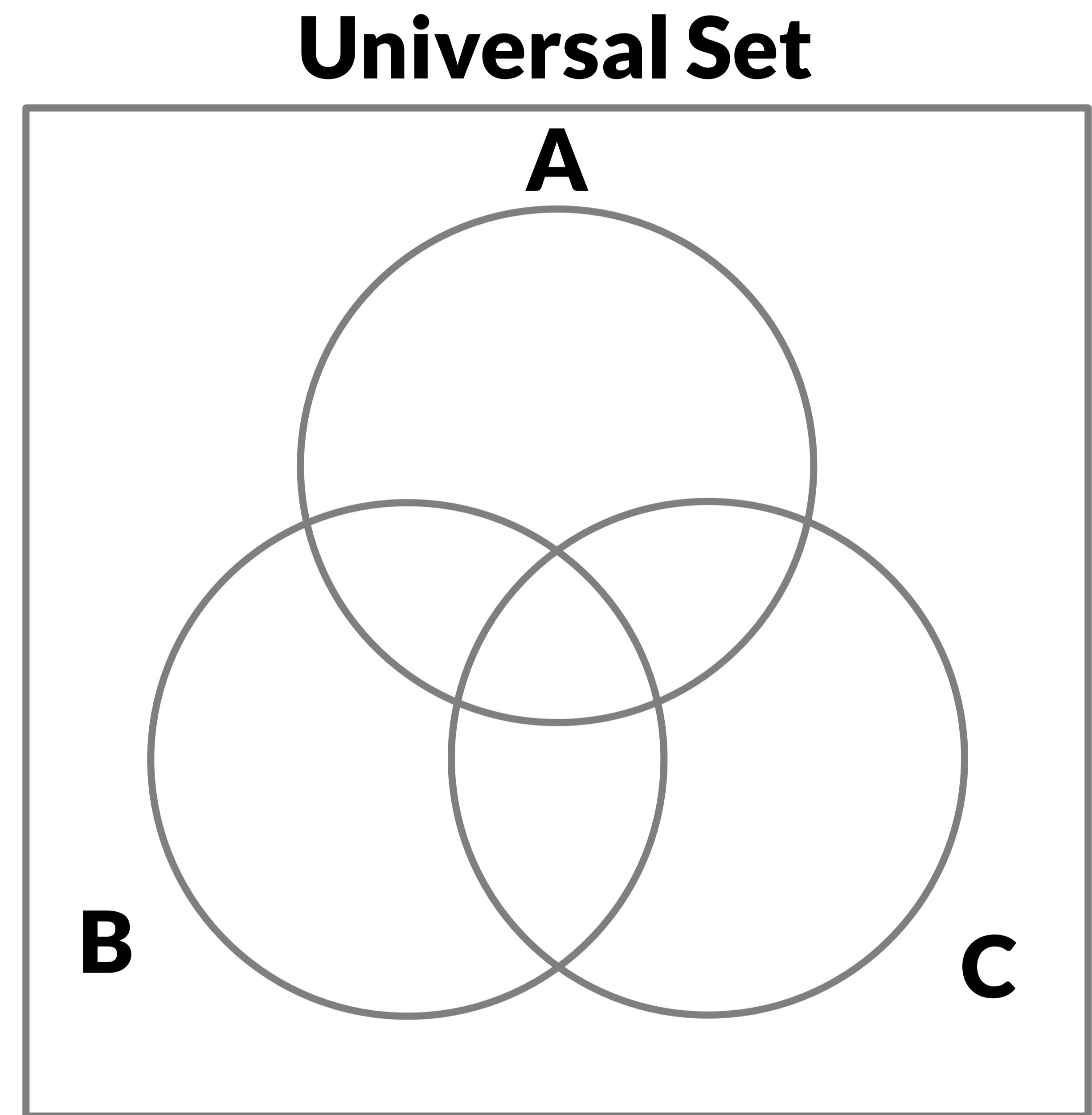
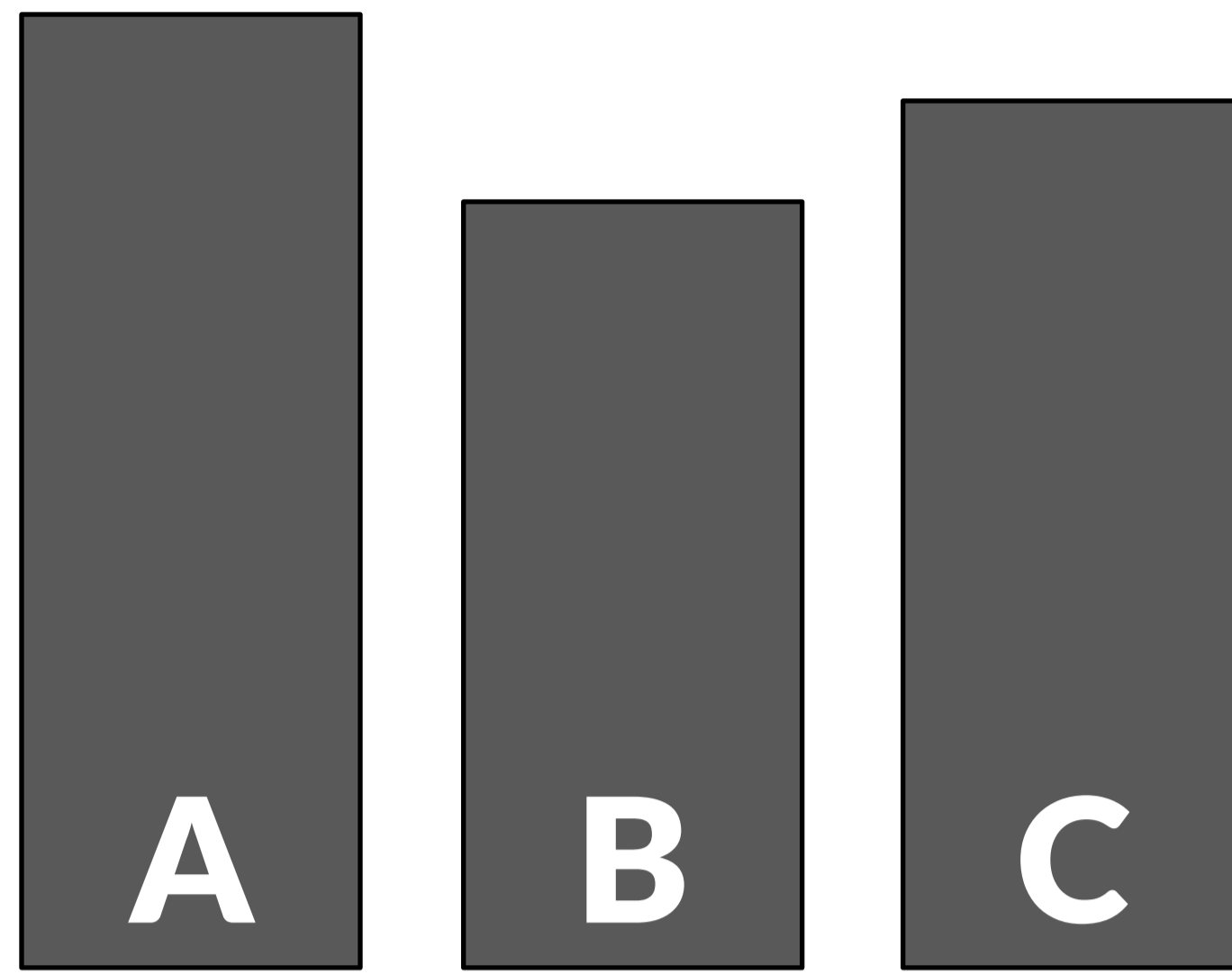

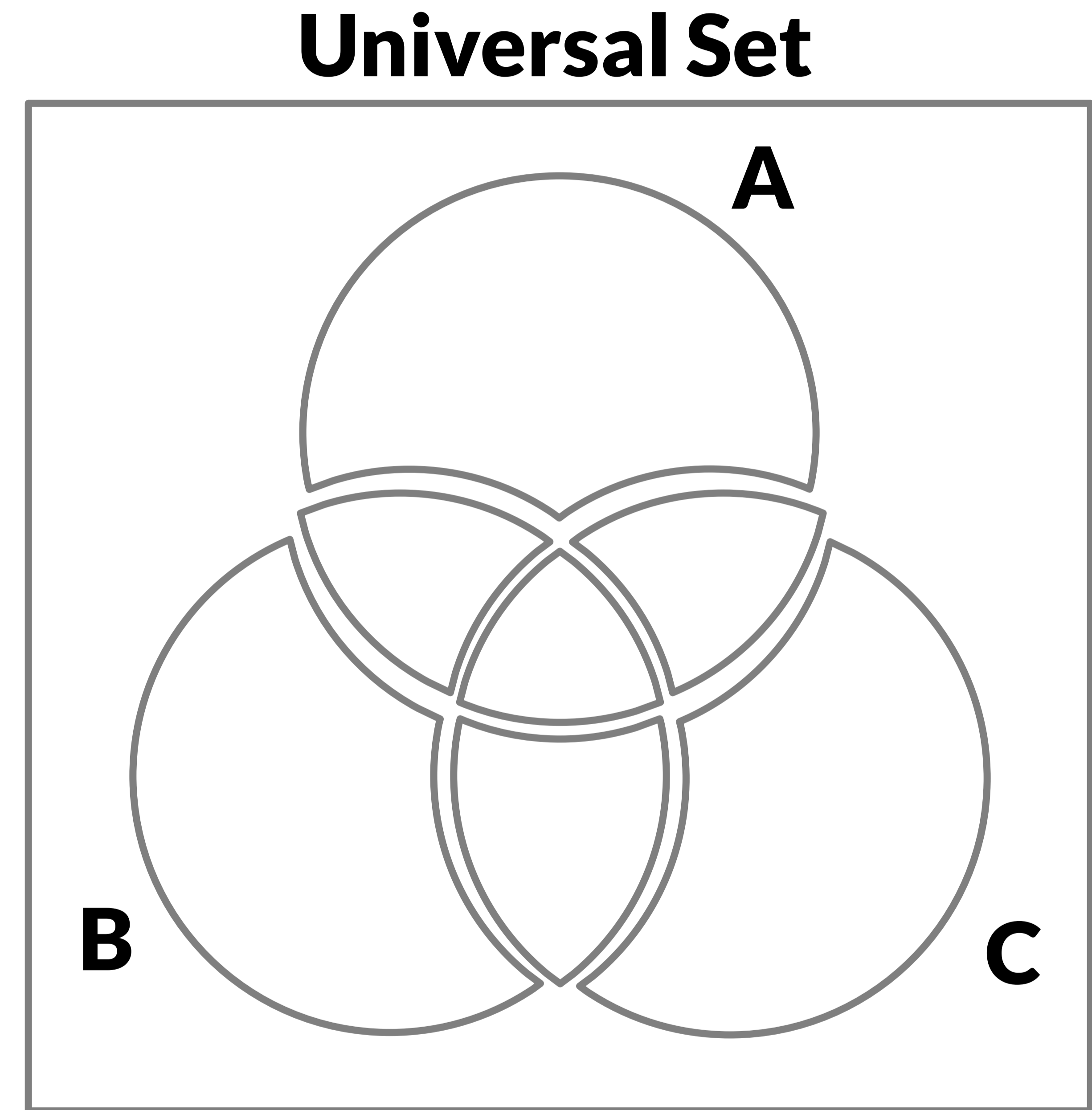
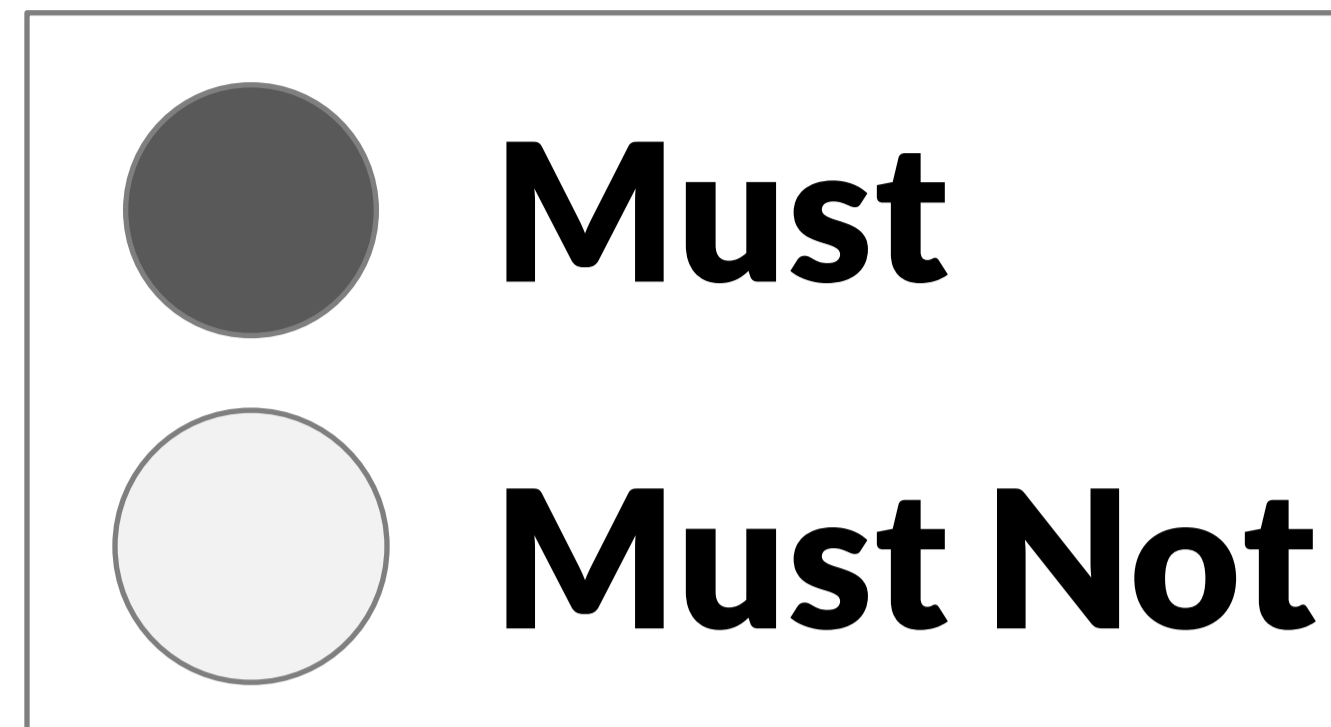
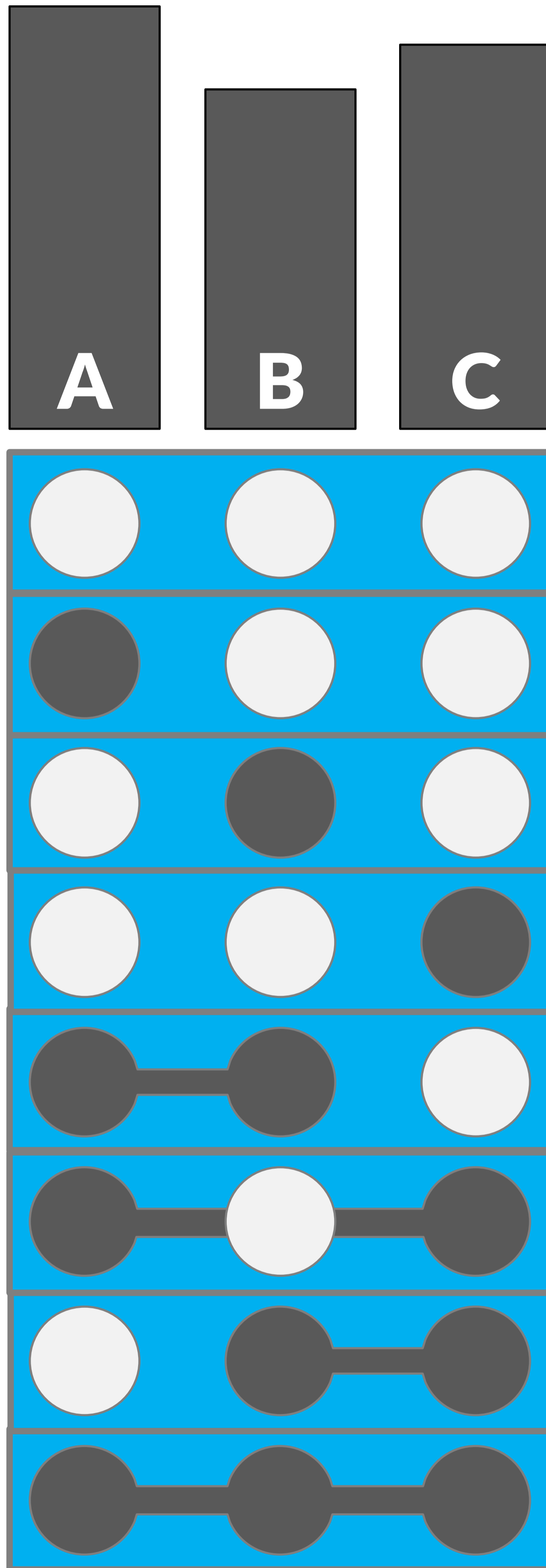

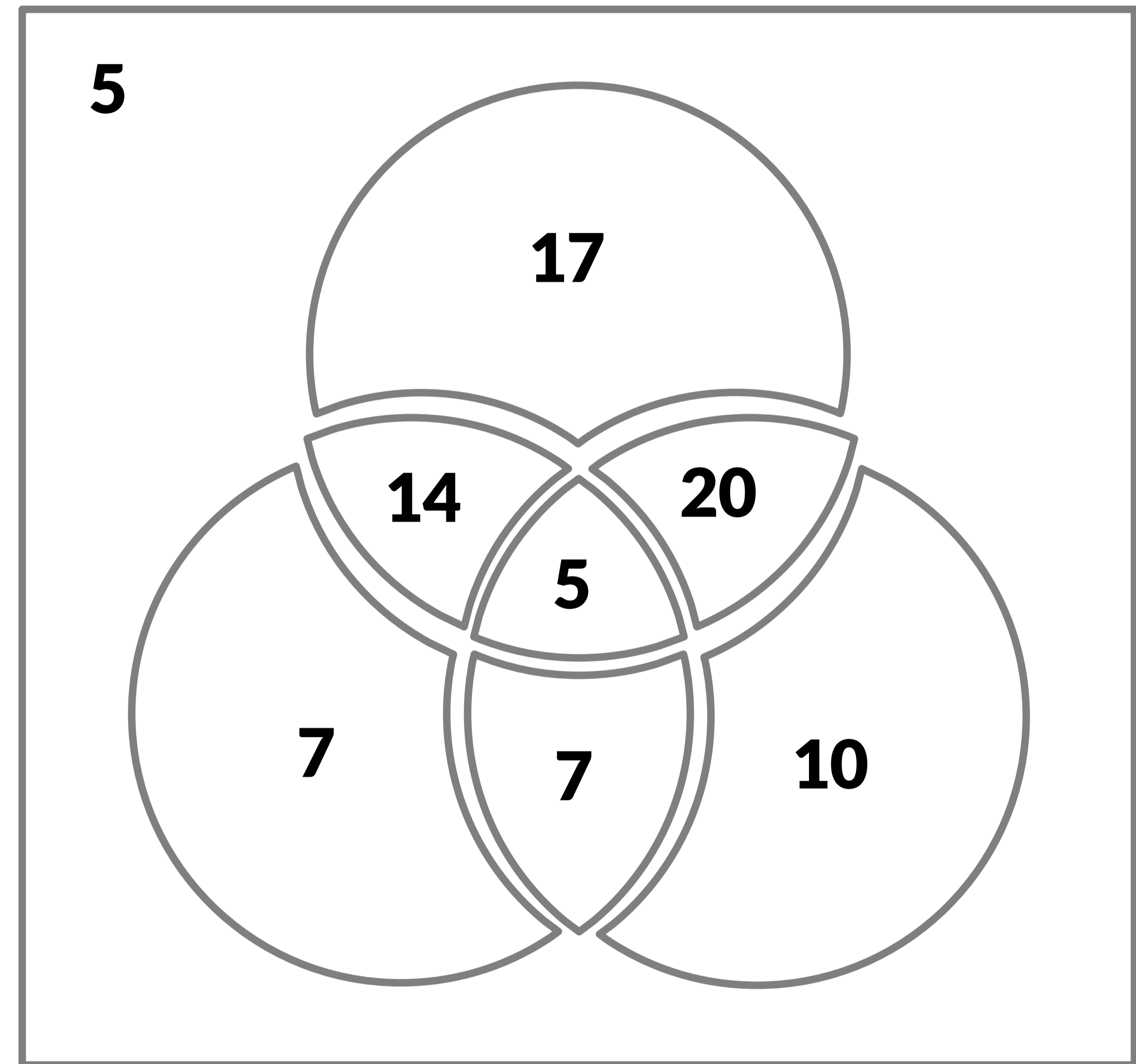
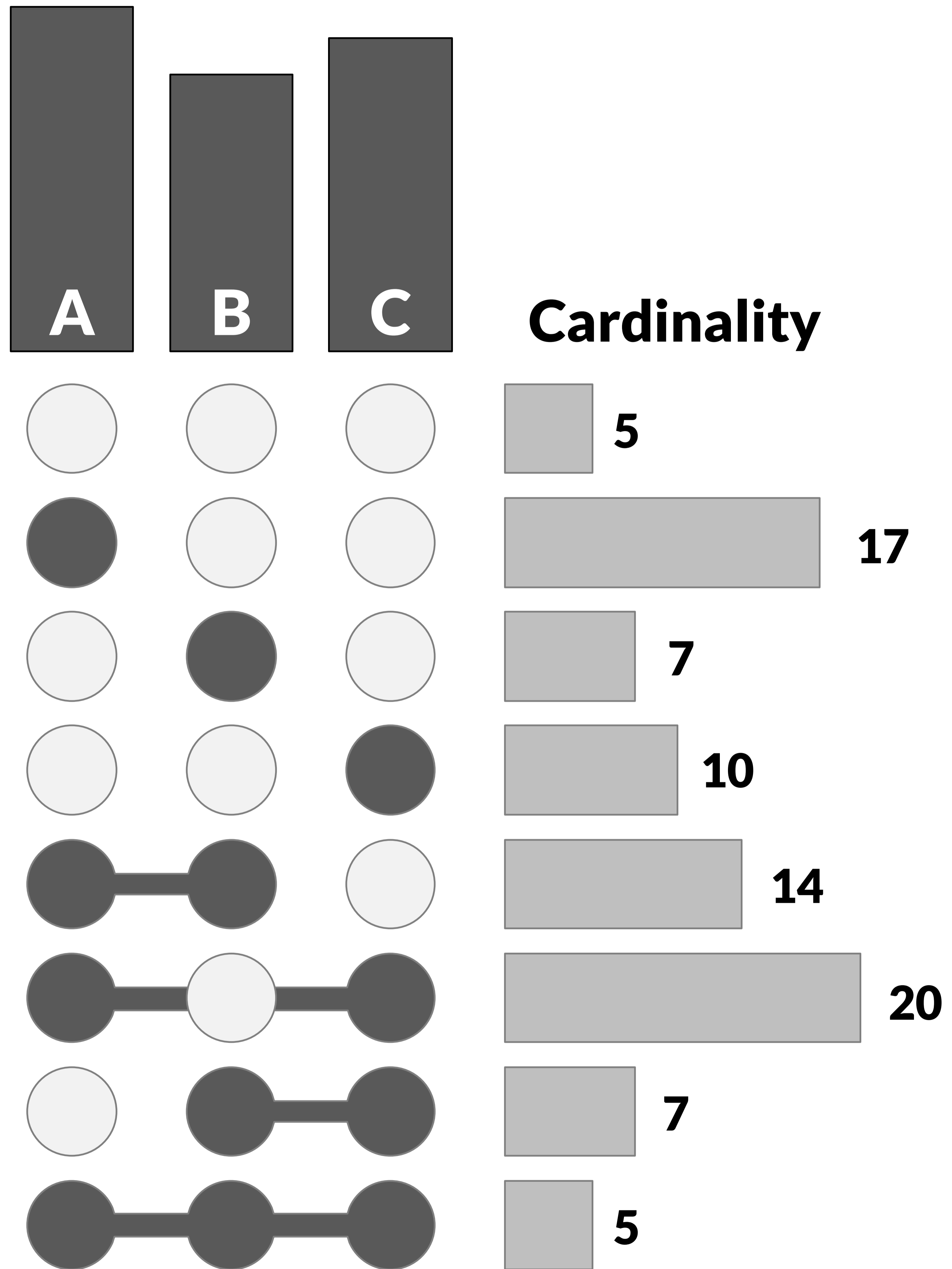

Plotting Attributes

**How surprising is the size of an intersection?
 What's the distribution of an
 attribute in an intersection?**

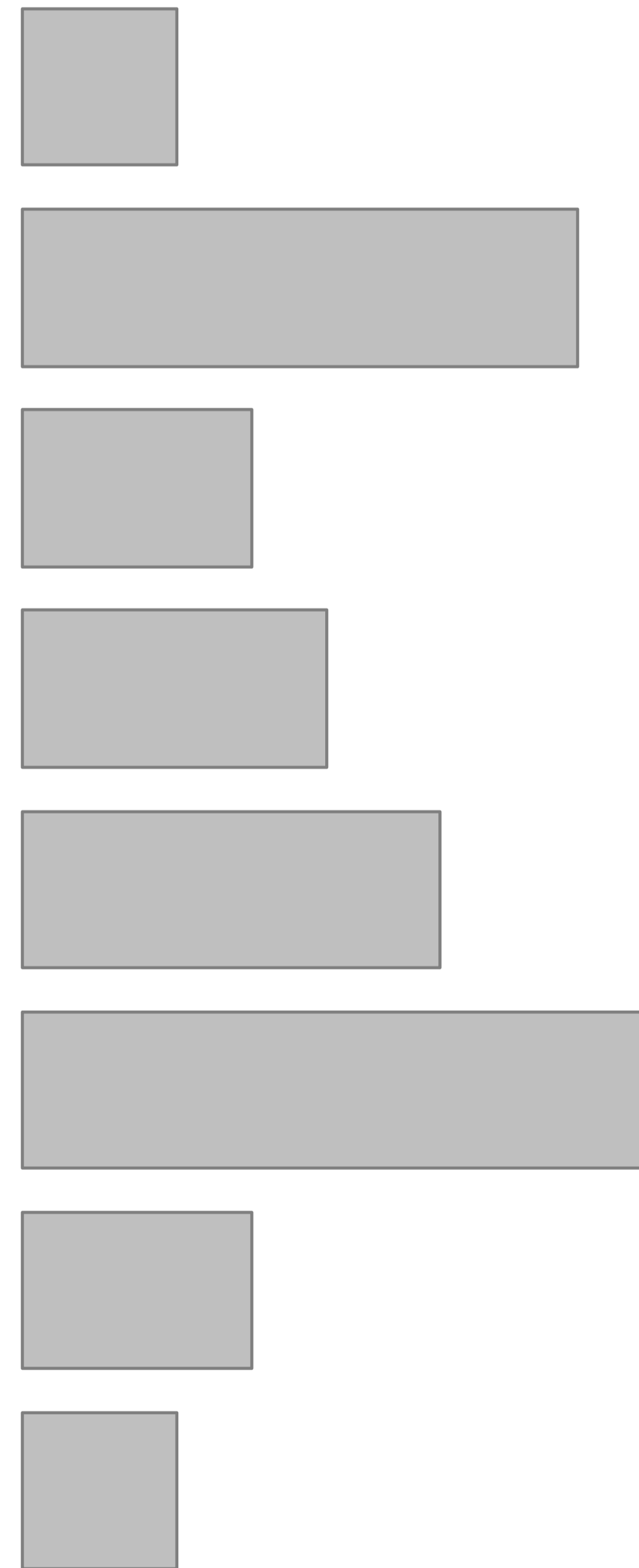
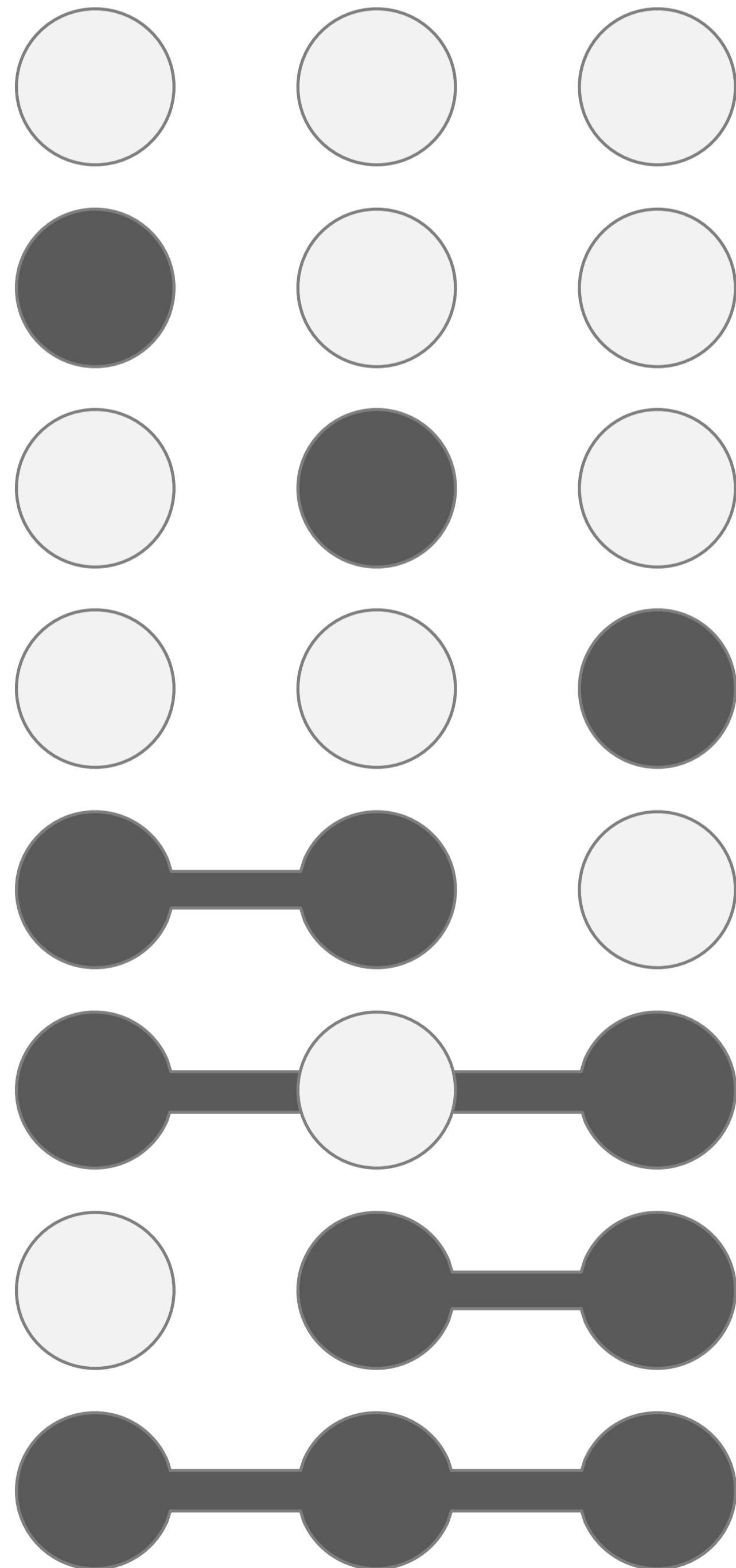
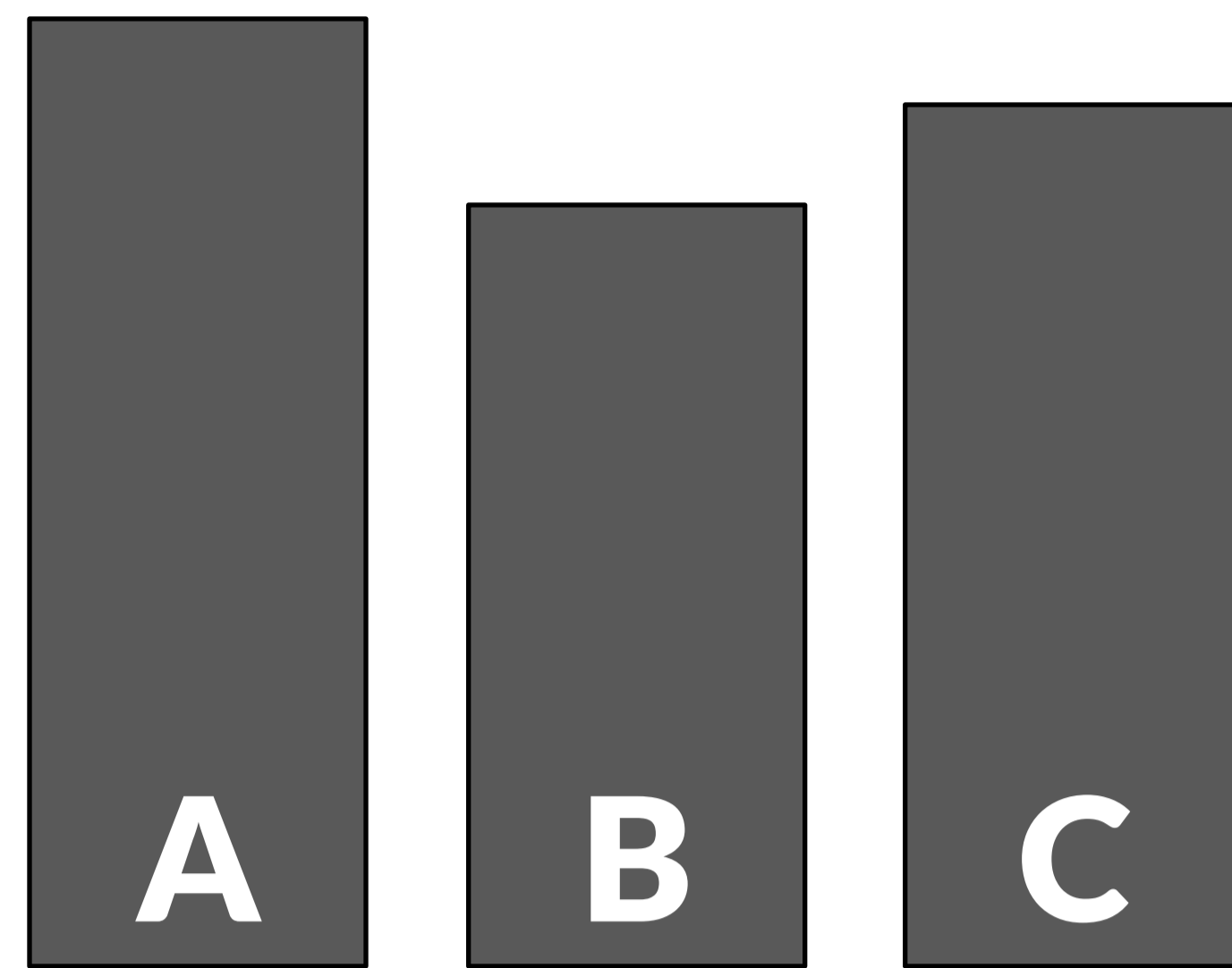

Deviation

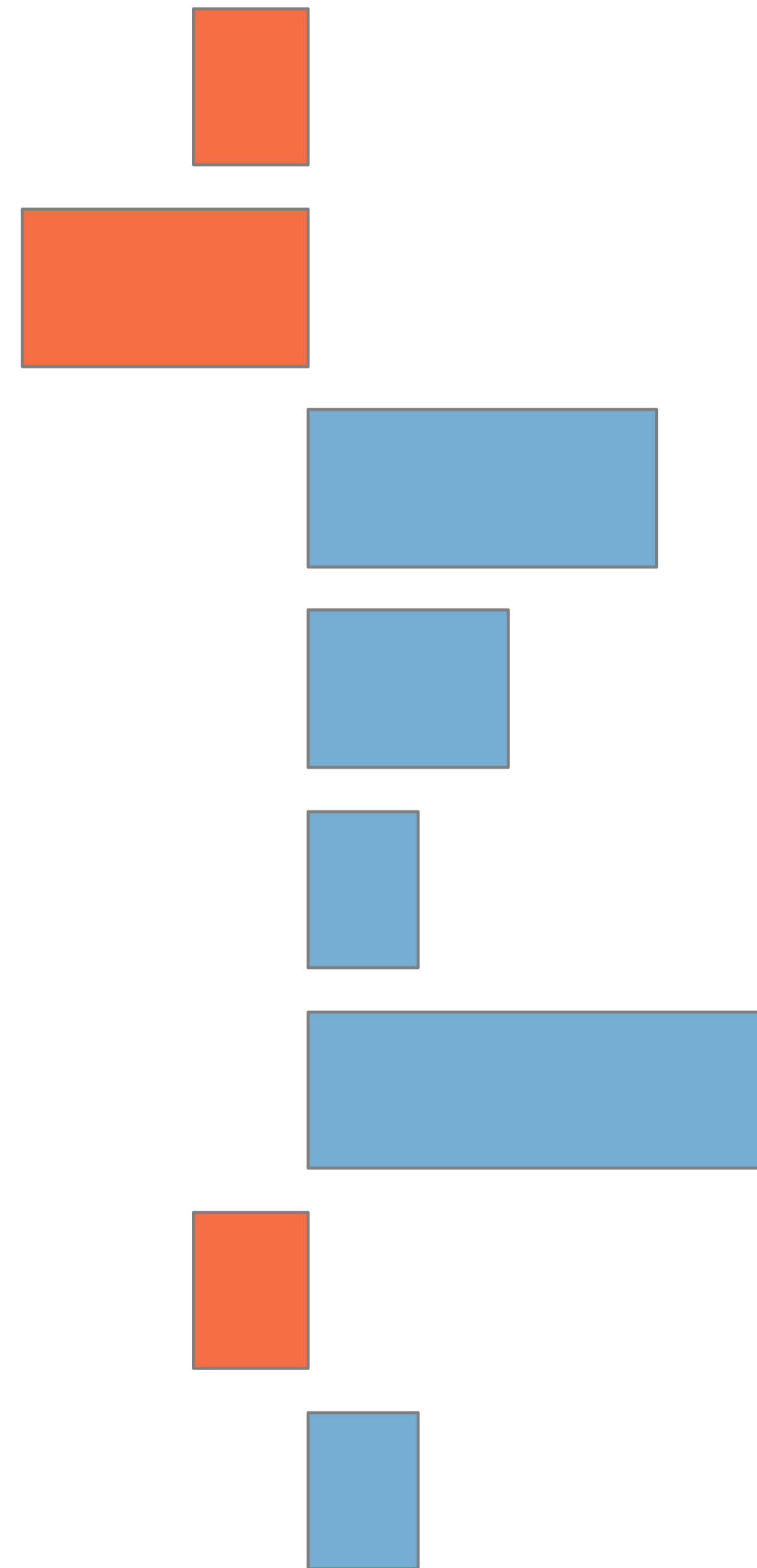

Attributes

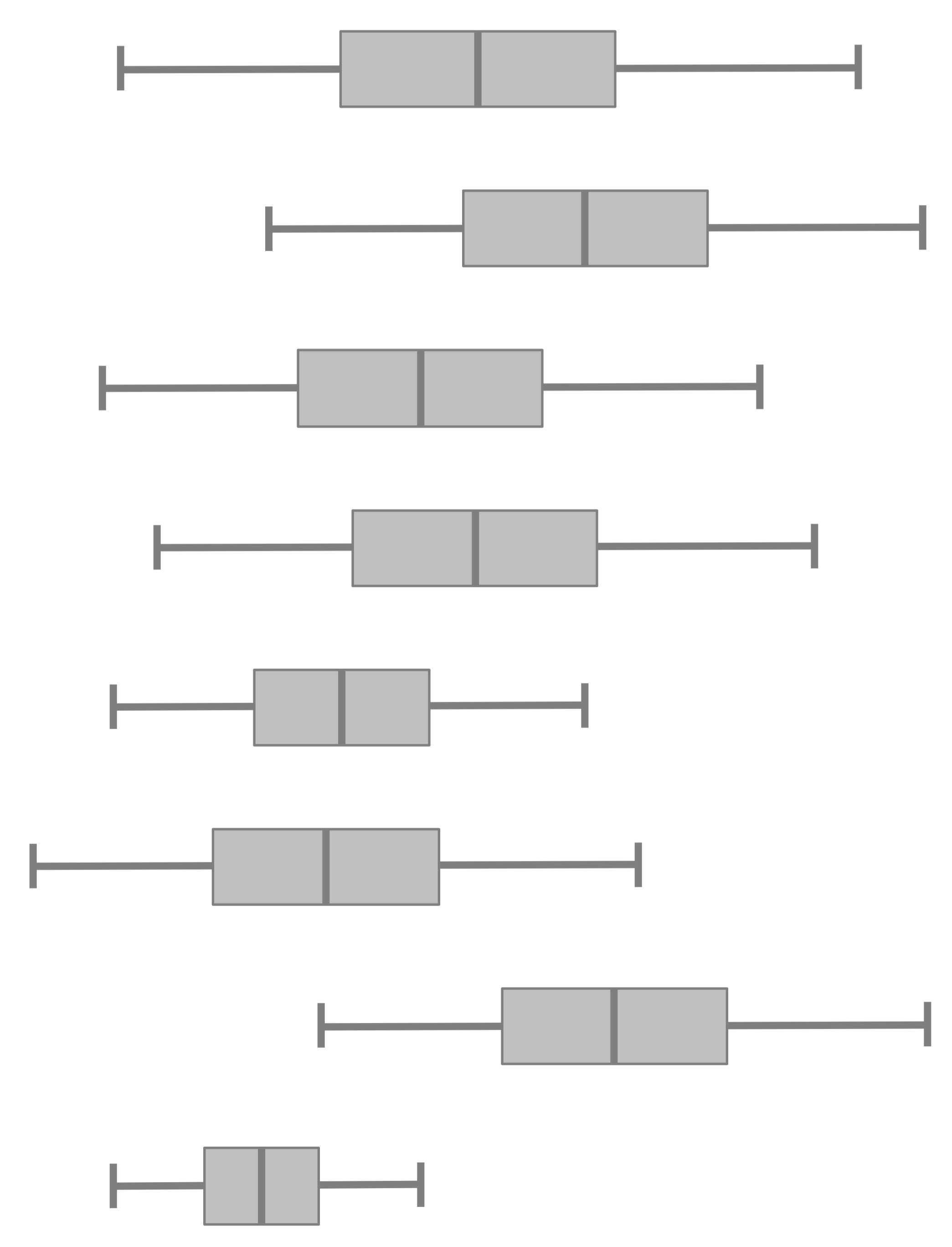

First, aggregate by
 Don't Aggregate

Then, aggregate by
 Don't Aggregate

Sort by
 Degree
 Cardinality
 Deviation

Aggregates

Row Height
 Large

Data
 Min Degree: 0
 Max Degree: 5
 Hide Empty Intersections

Dataset Information
 Name: Movies
 Genres
 # Sets: 17
 # Attributes: 6
 # Elements: 3883
 Author: grouplens
 Description: MovieLens ratings dataset, curated and filtered by Alsallakh.
 Source: <http://grouplens.org/d..>

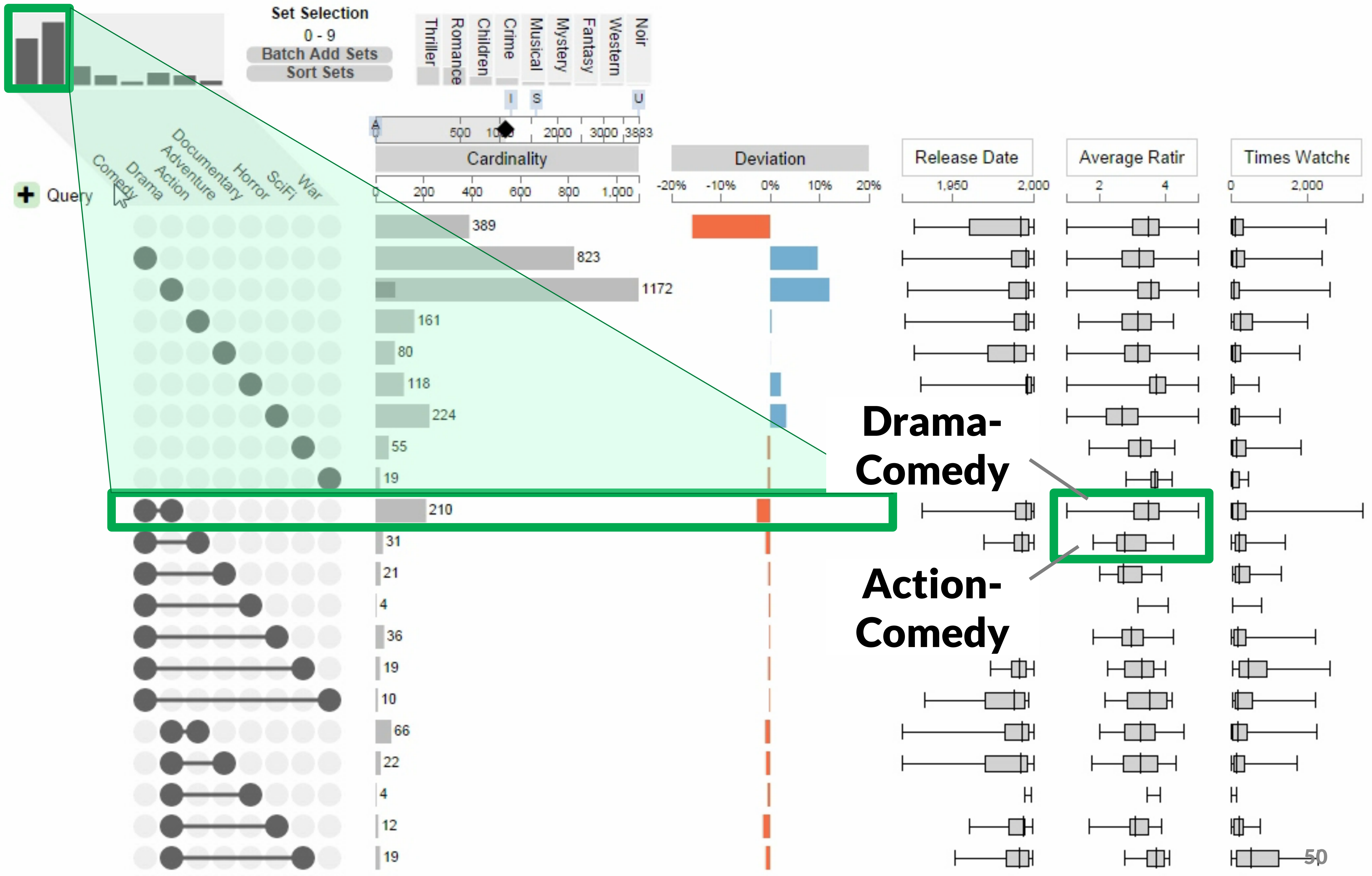

Sorting

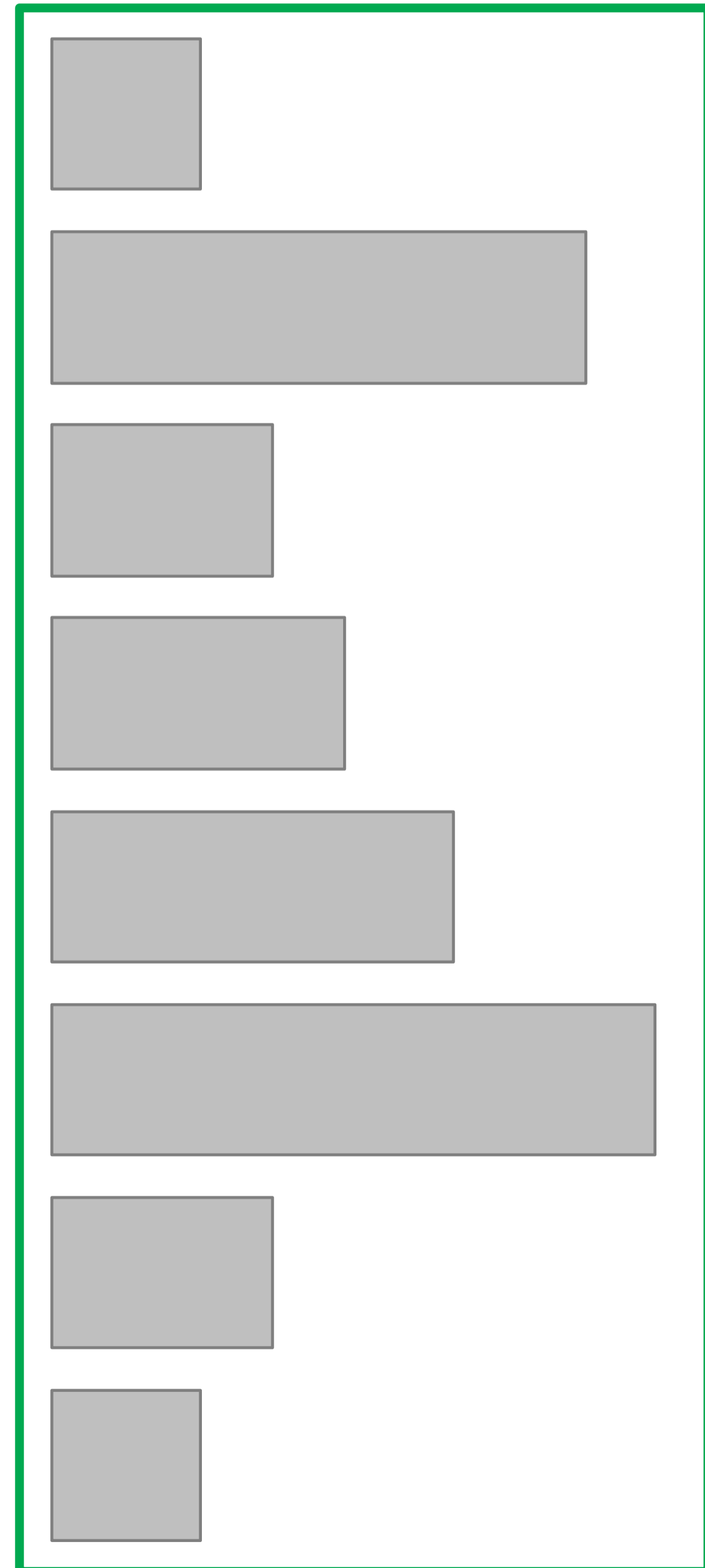
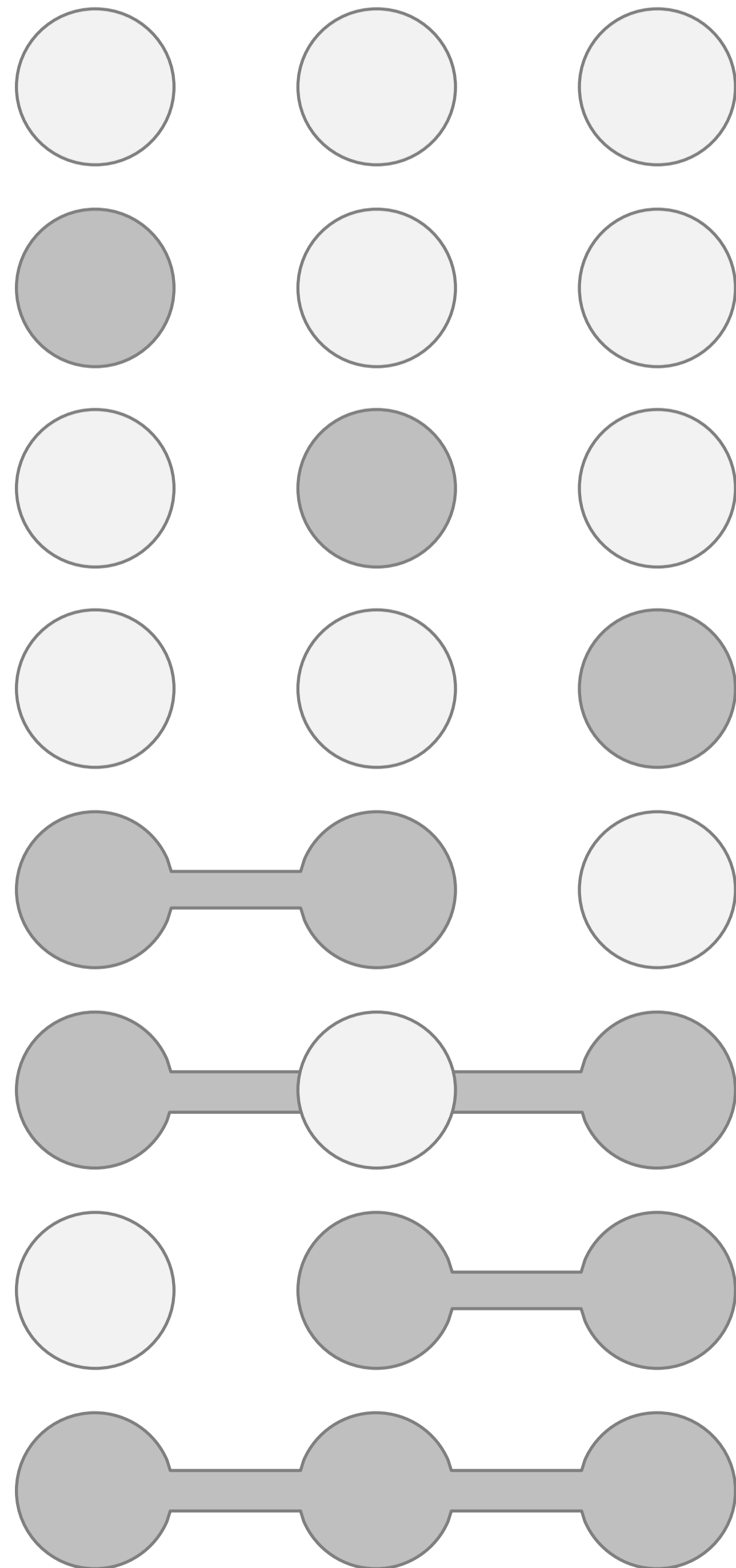
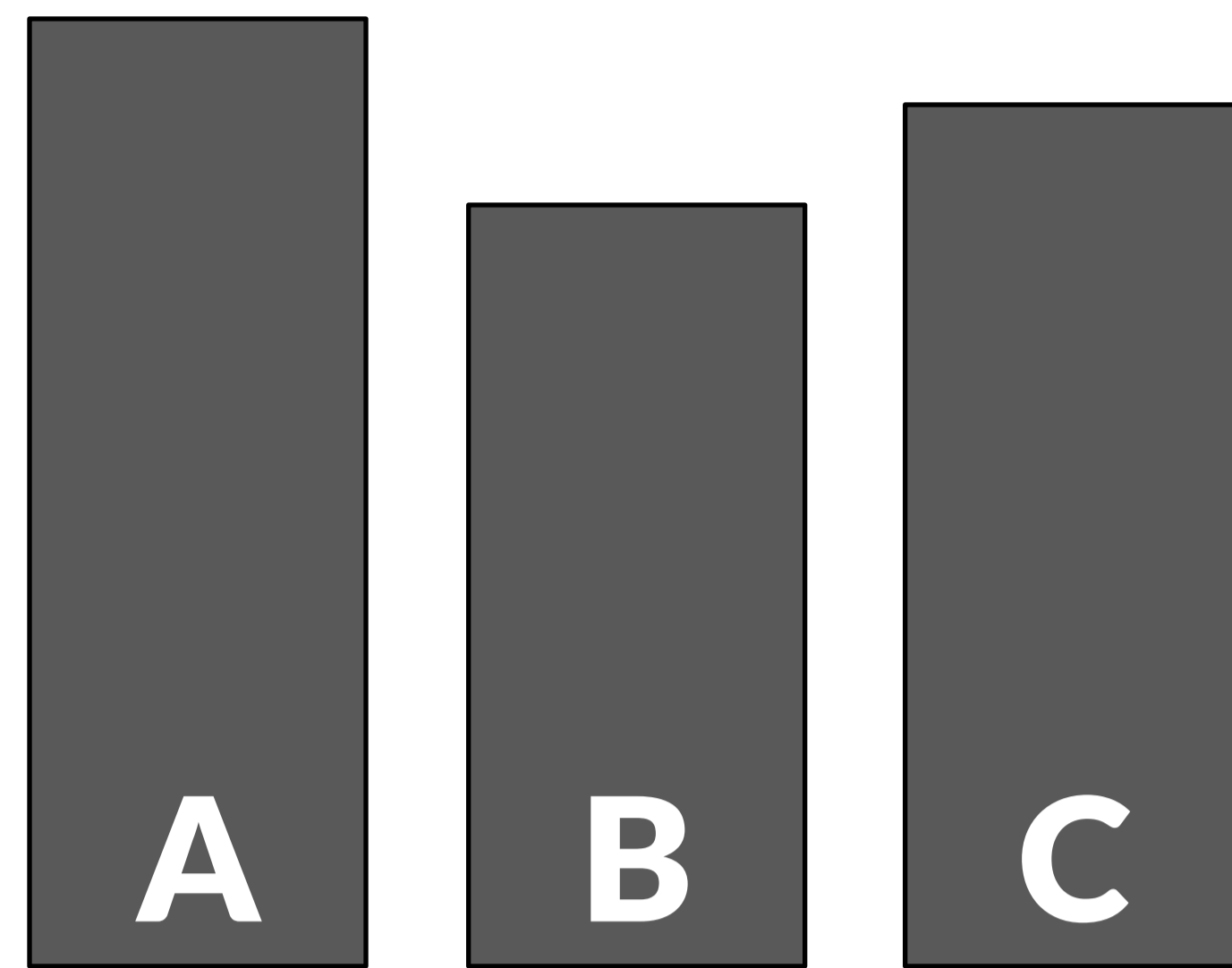

**Which is the biggest intersection?
Sort By: Cardinality**

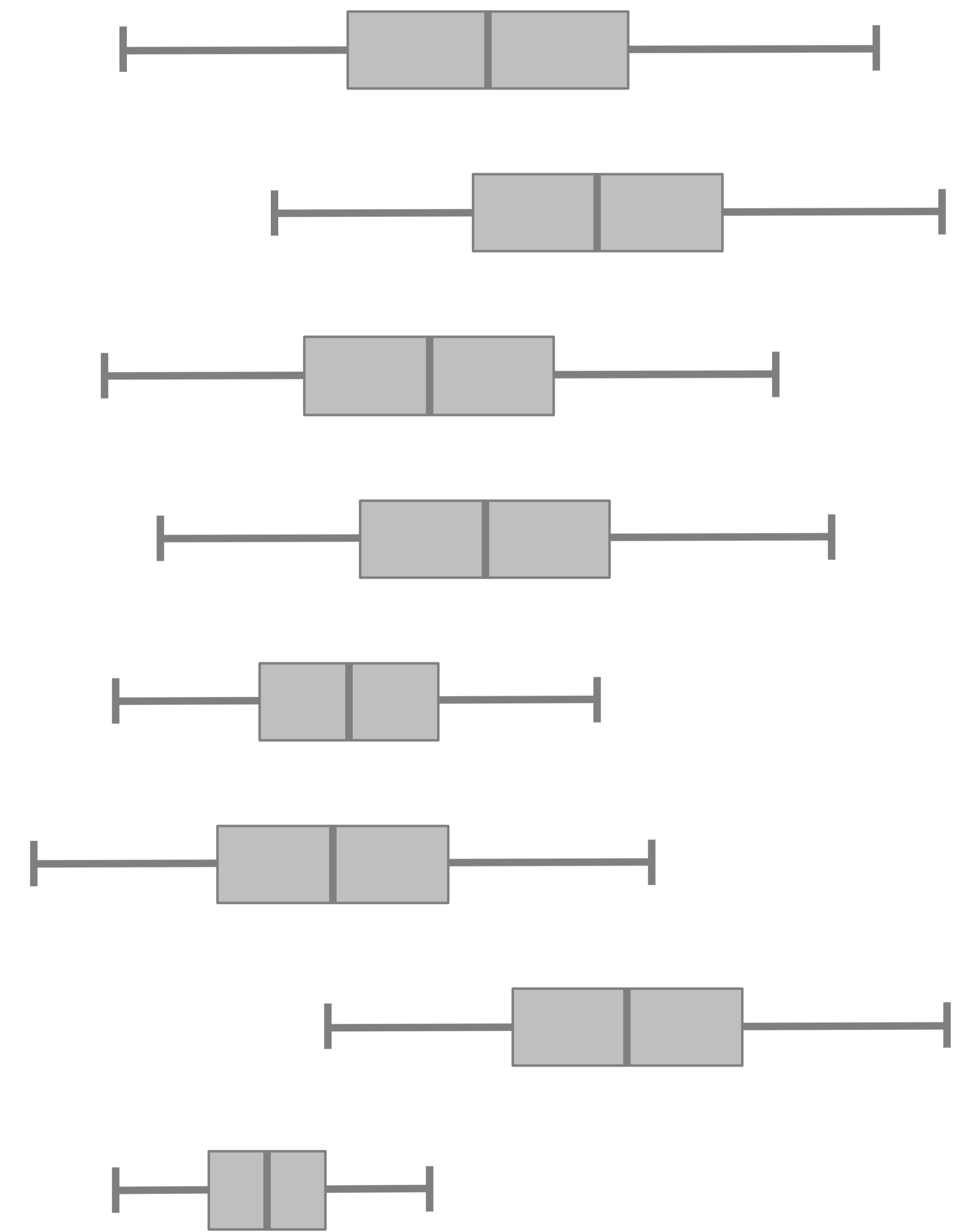
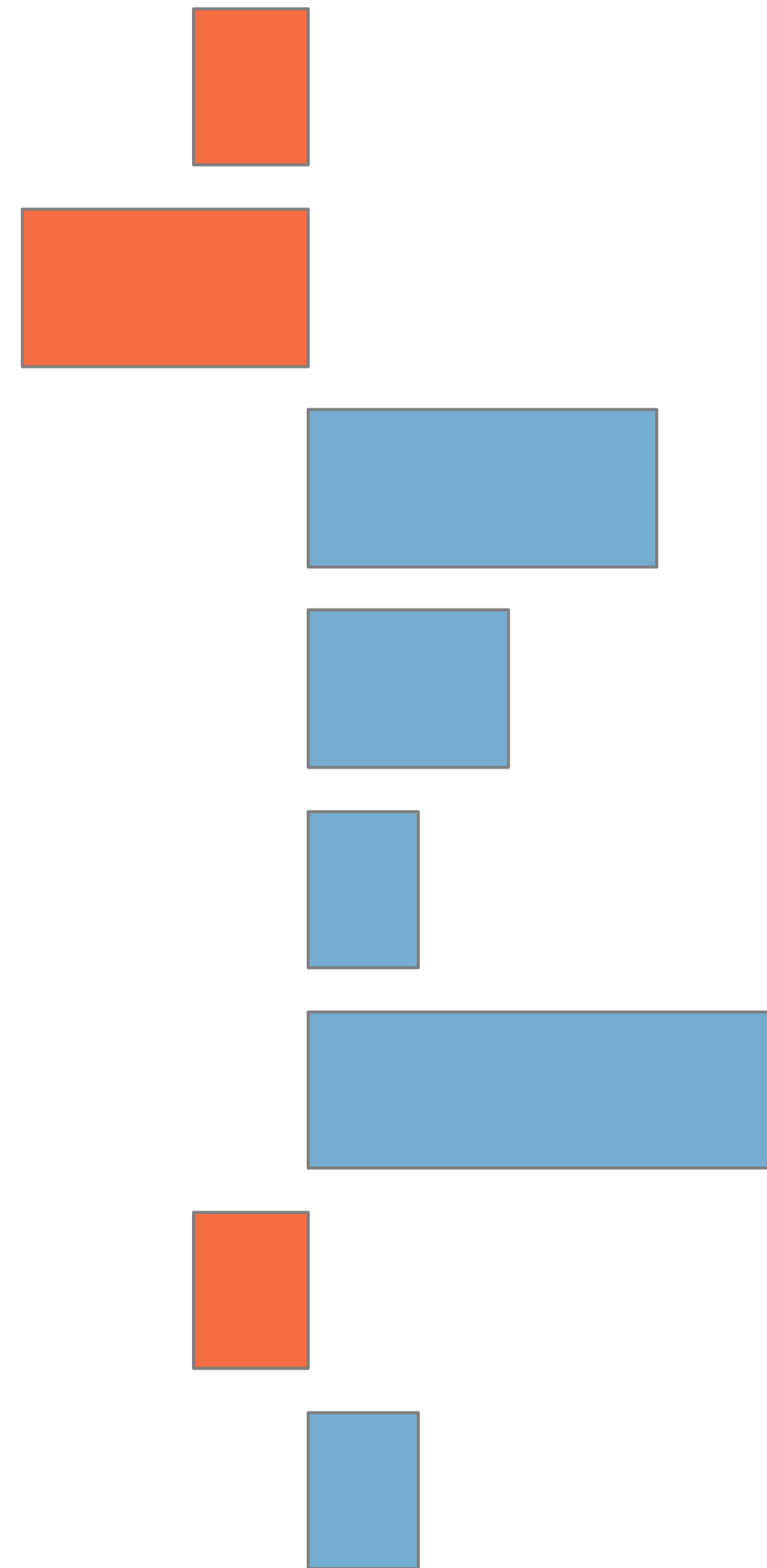

**Which is the most 'surprising' intersection?
Sort By: Deviation**

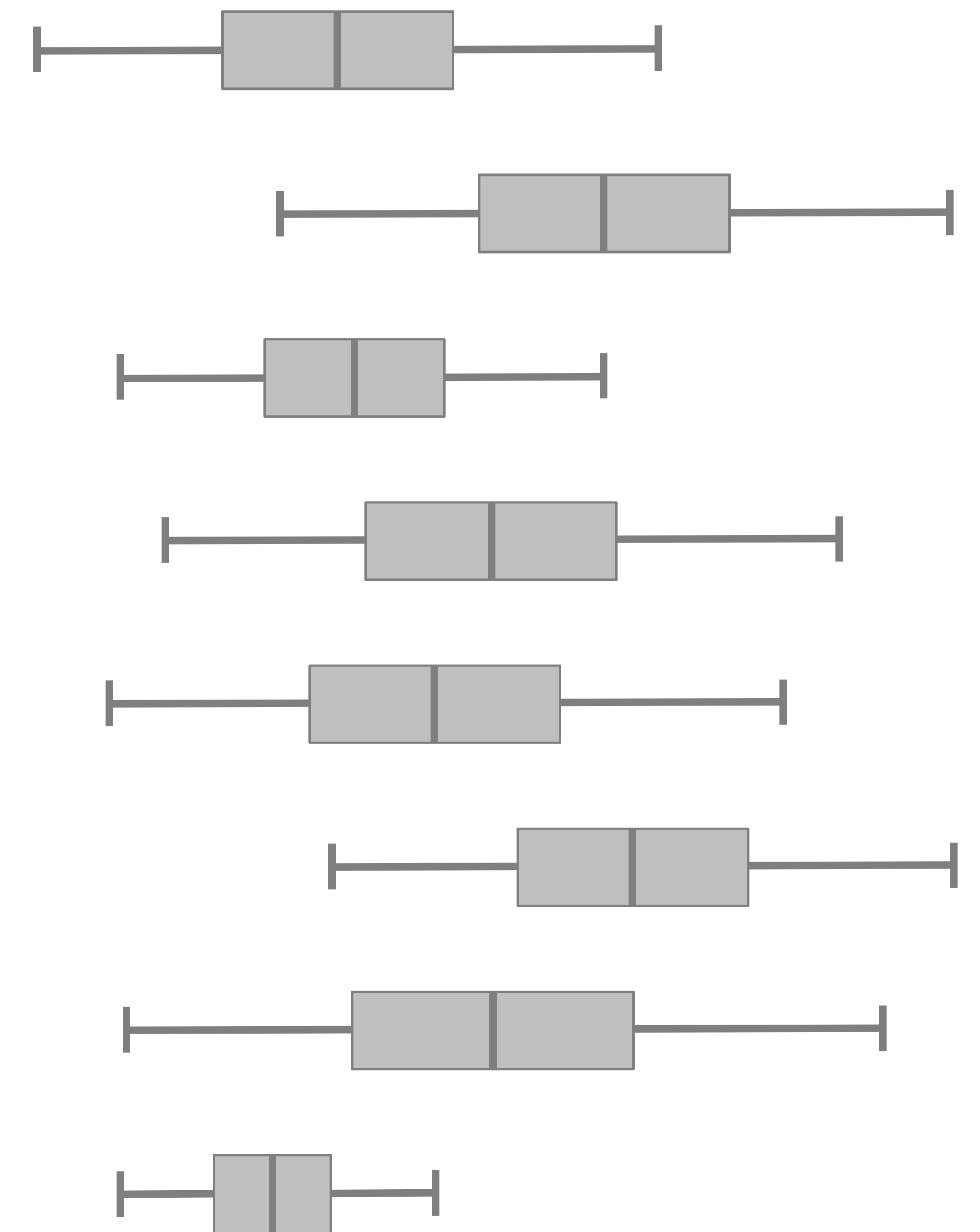
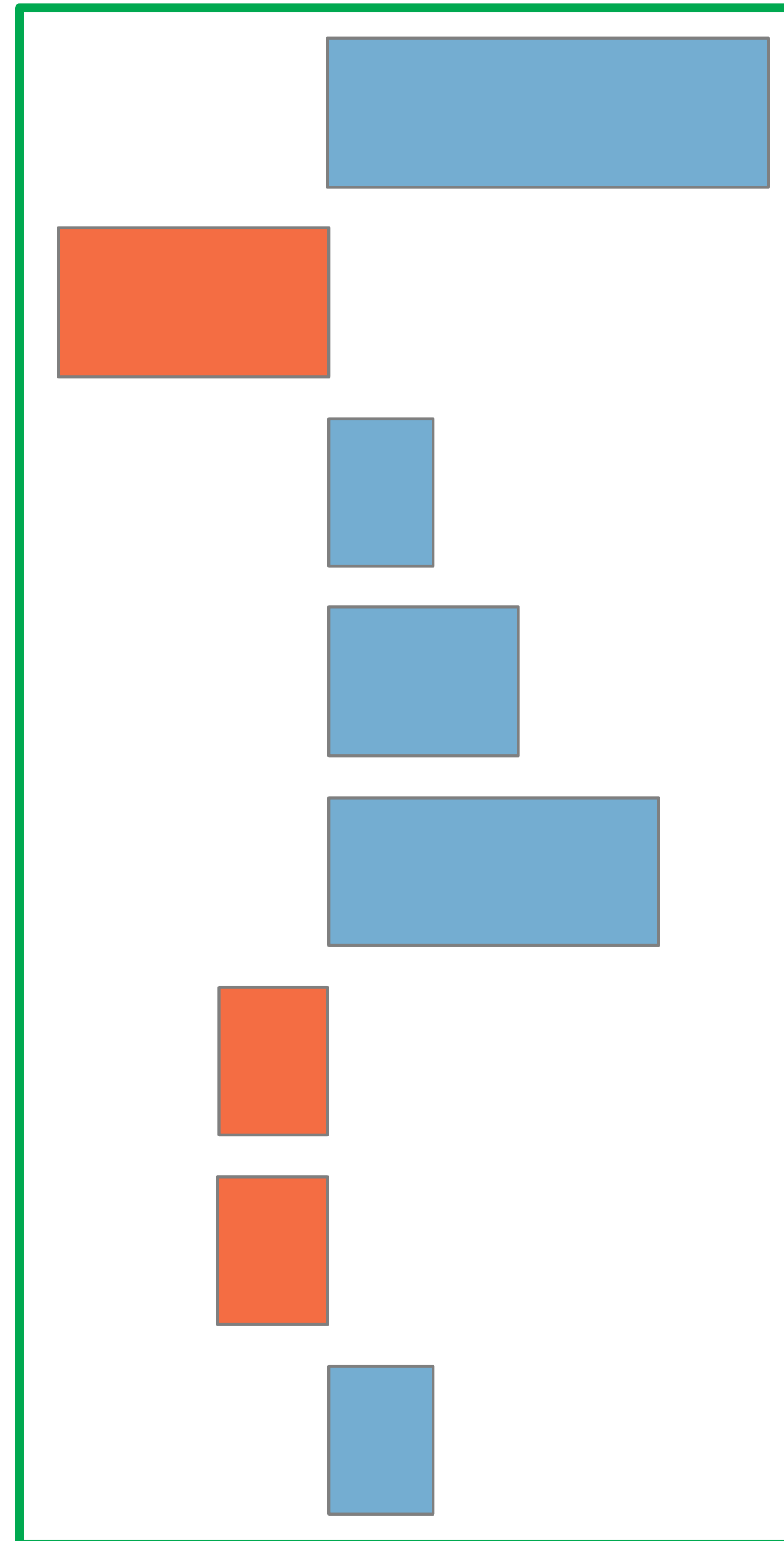
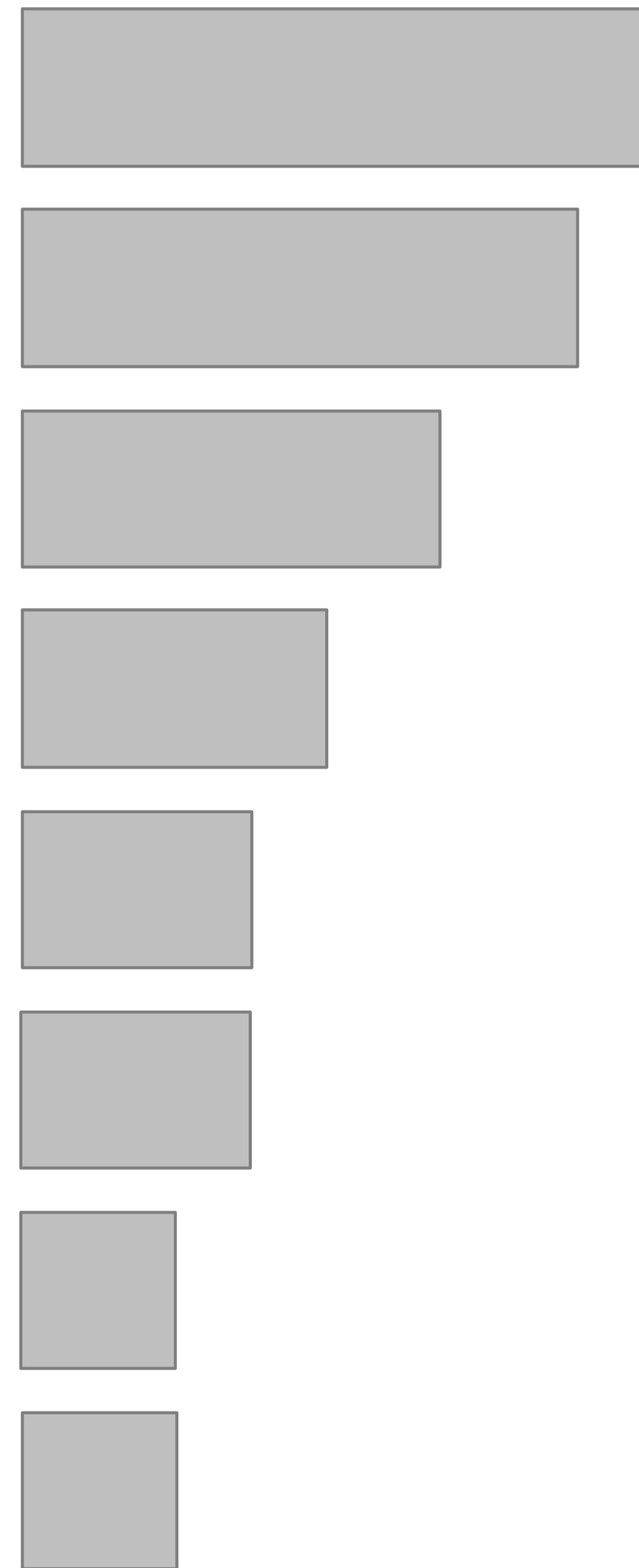
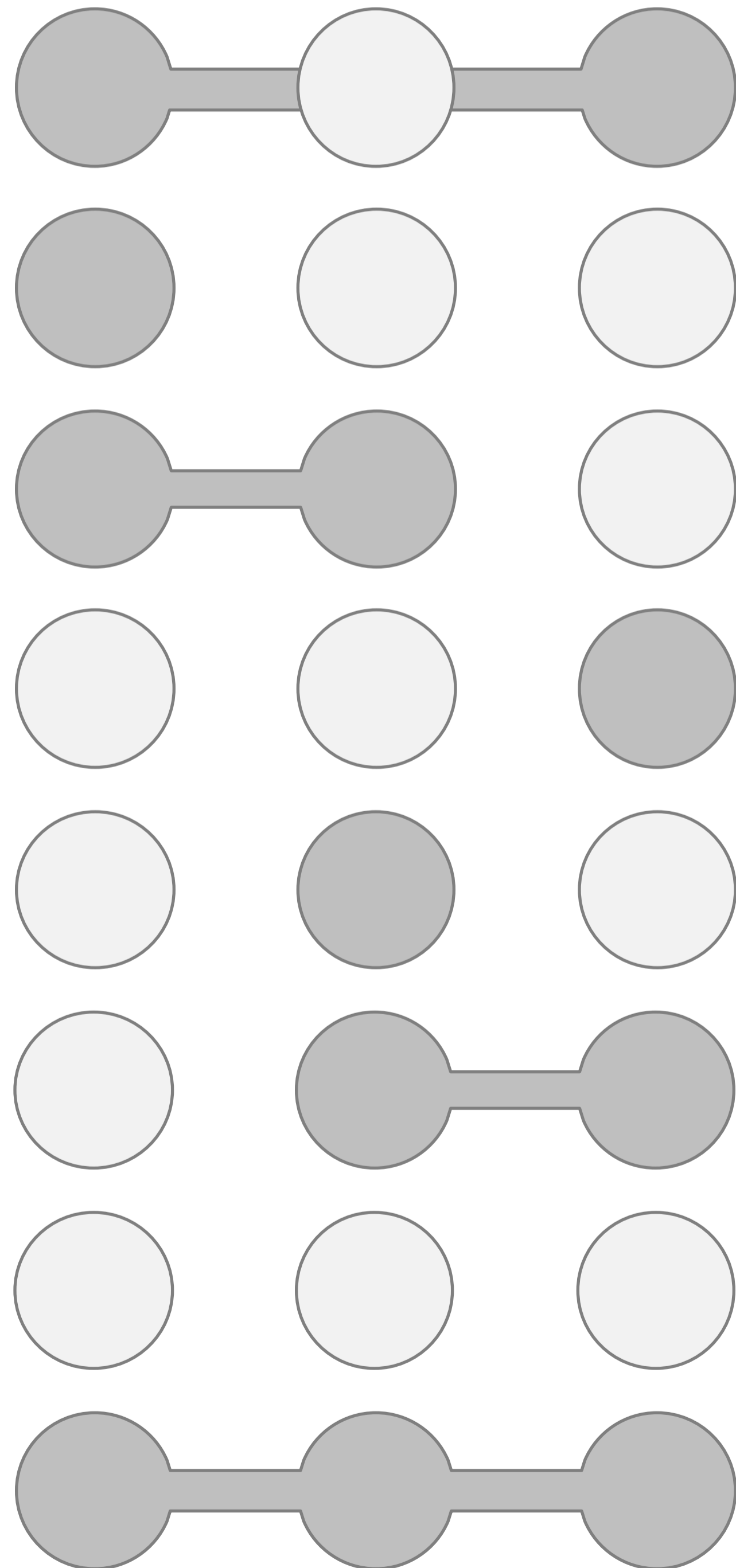
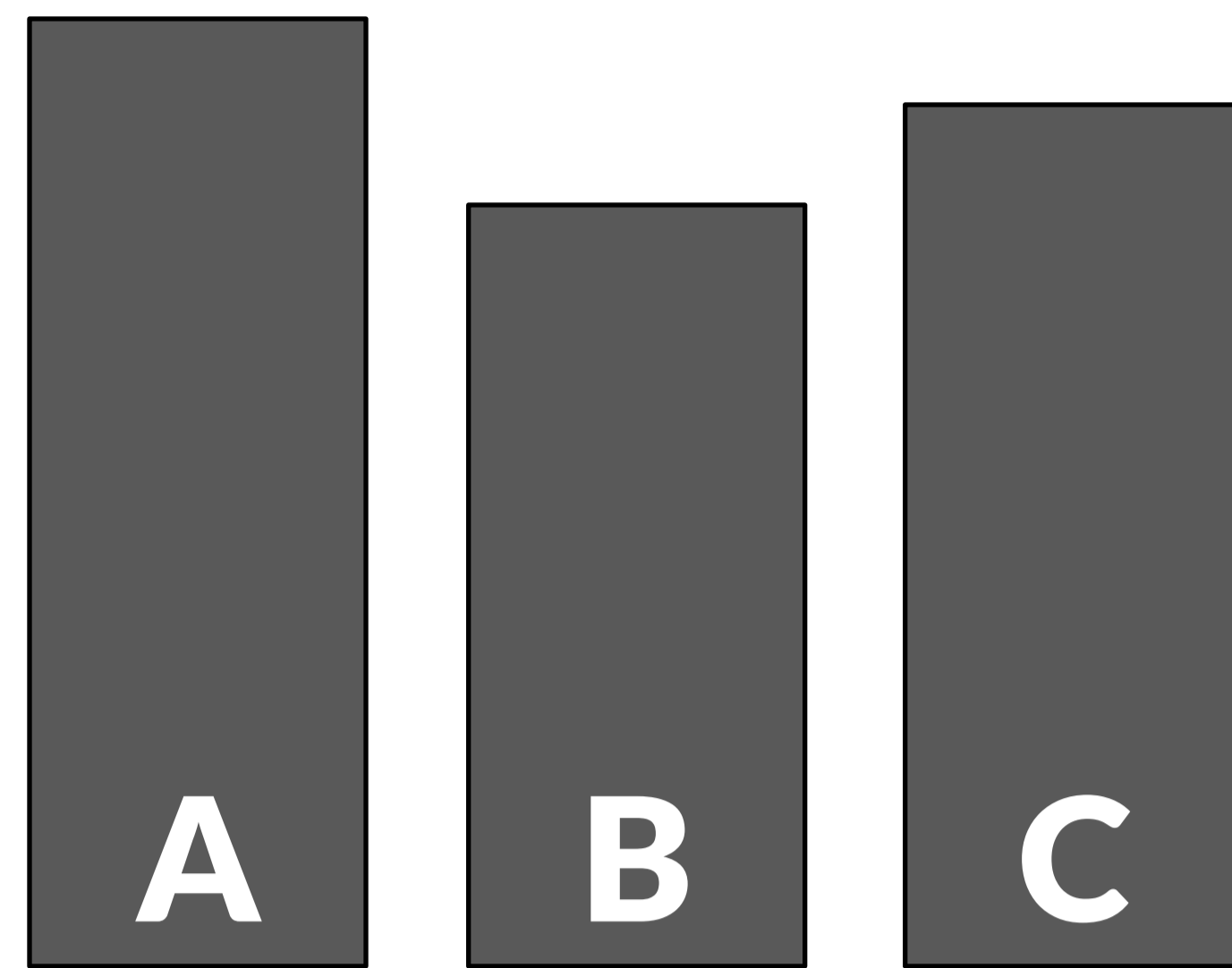

What are the properties of the intersections involving 'A'?
Sort By: Set

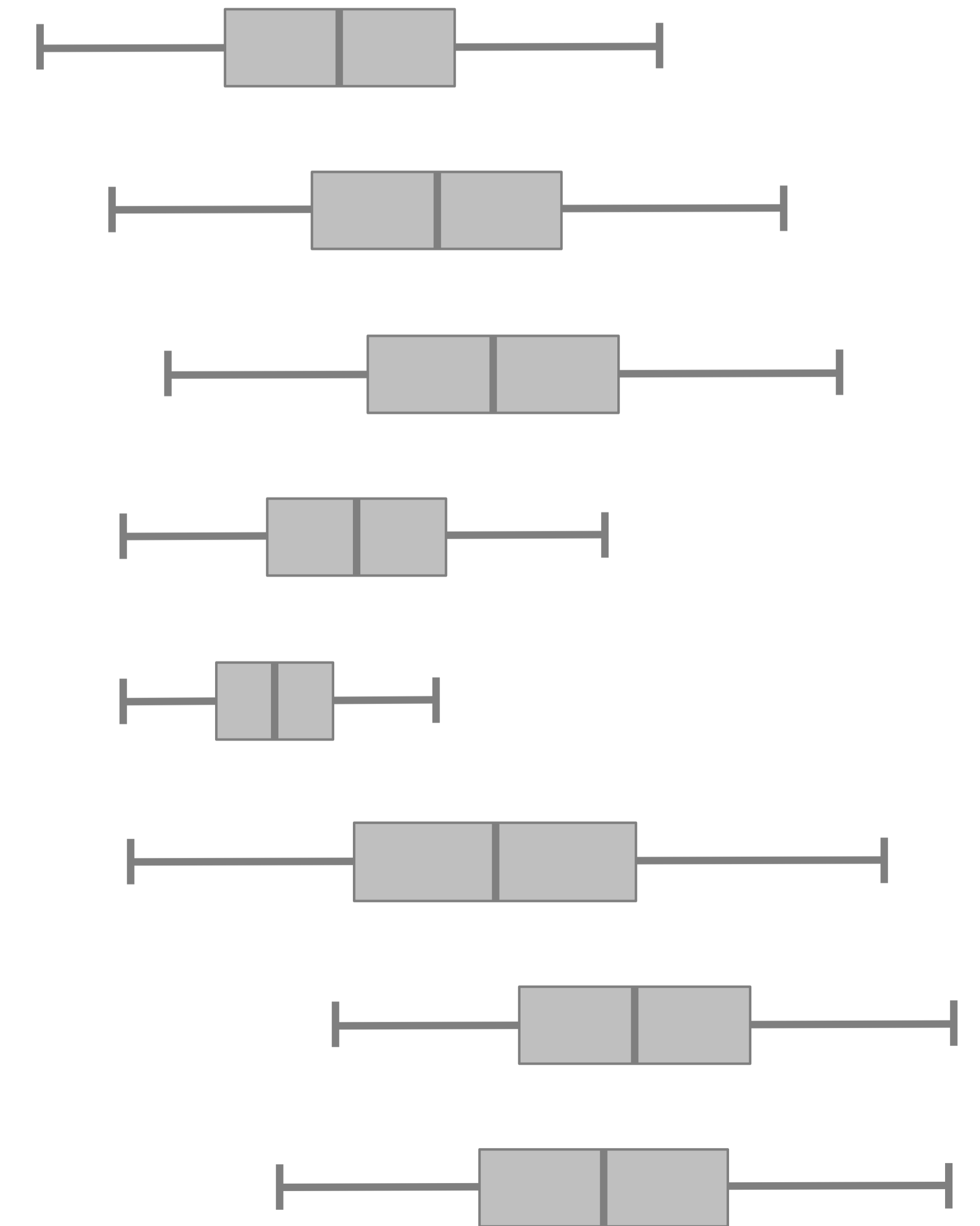
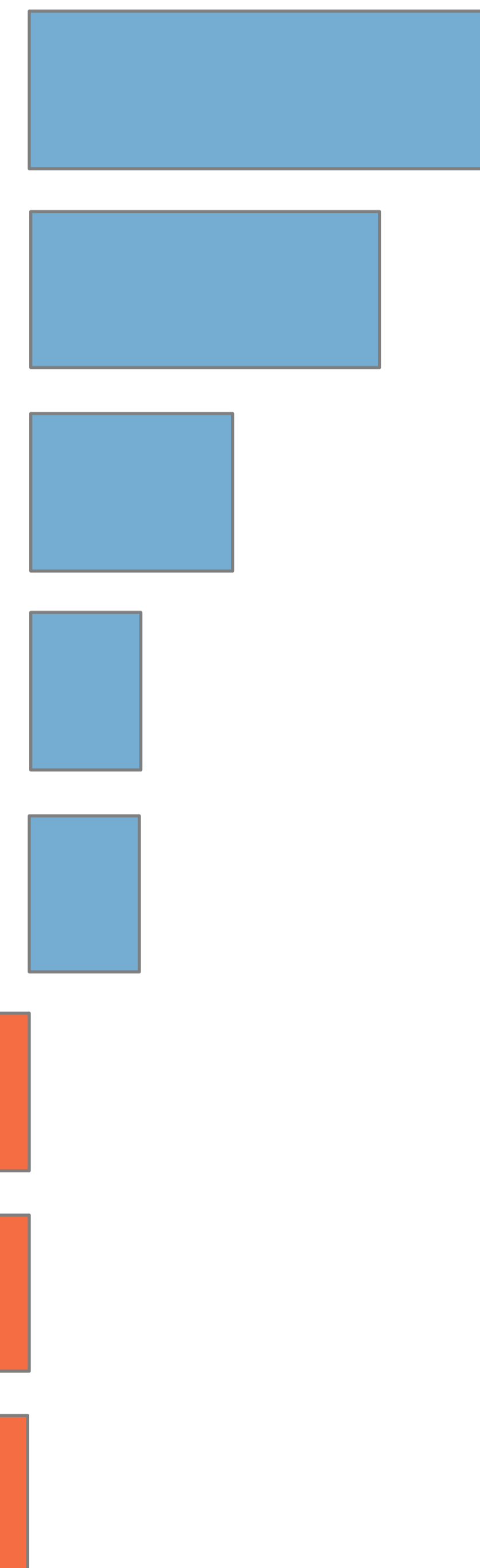
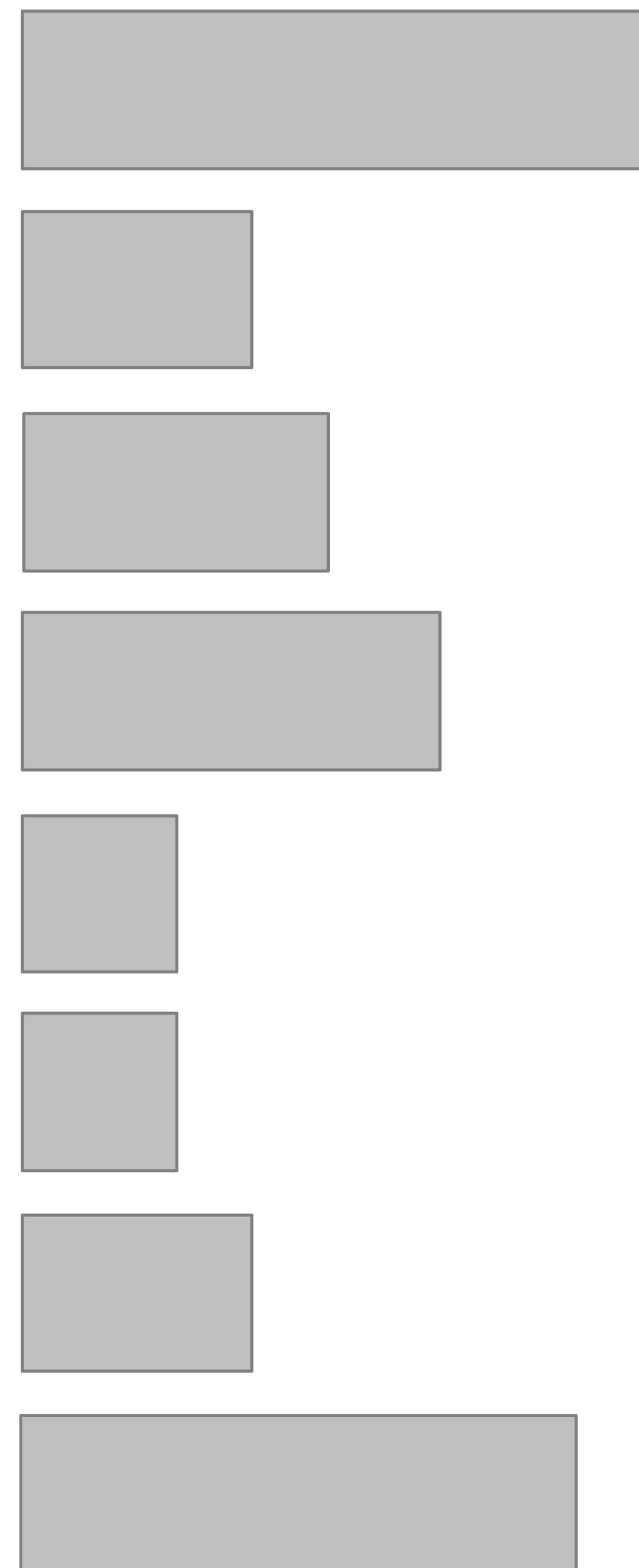
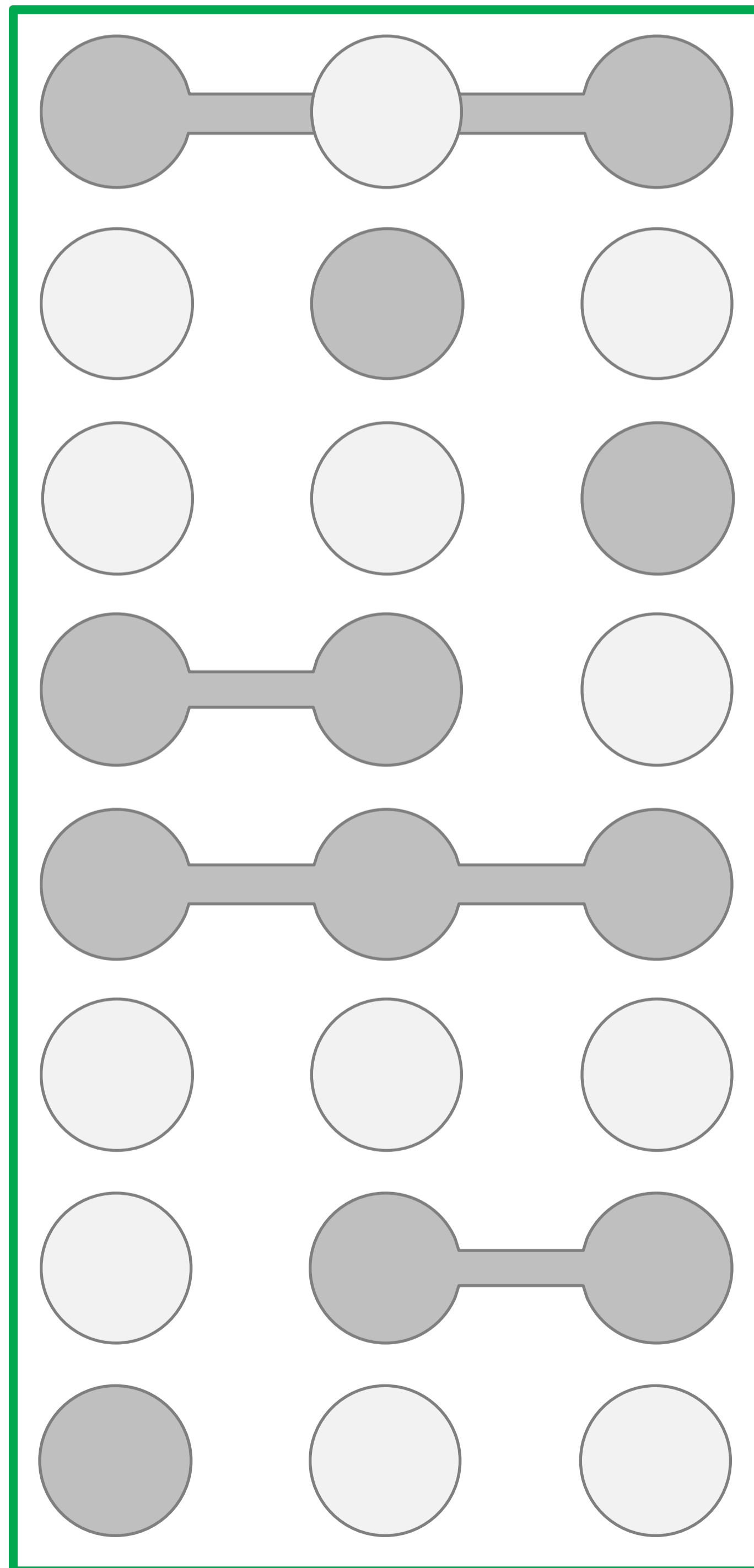
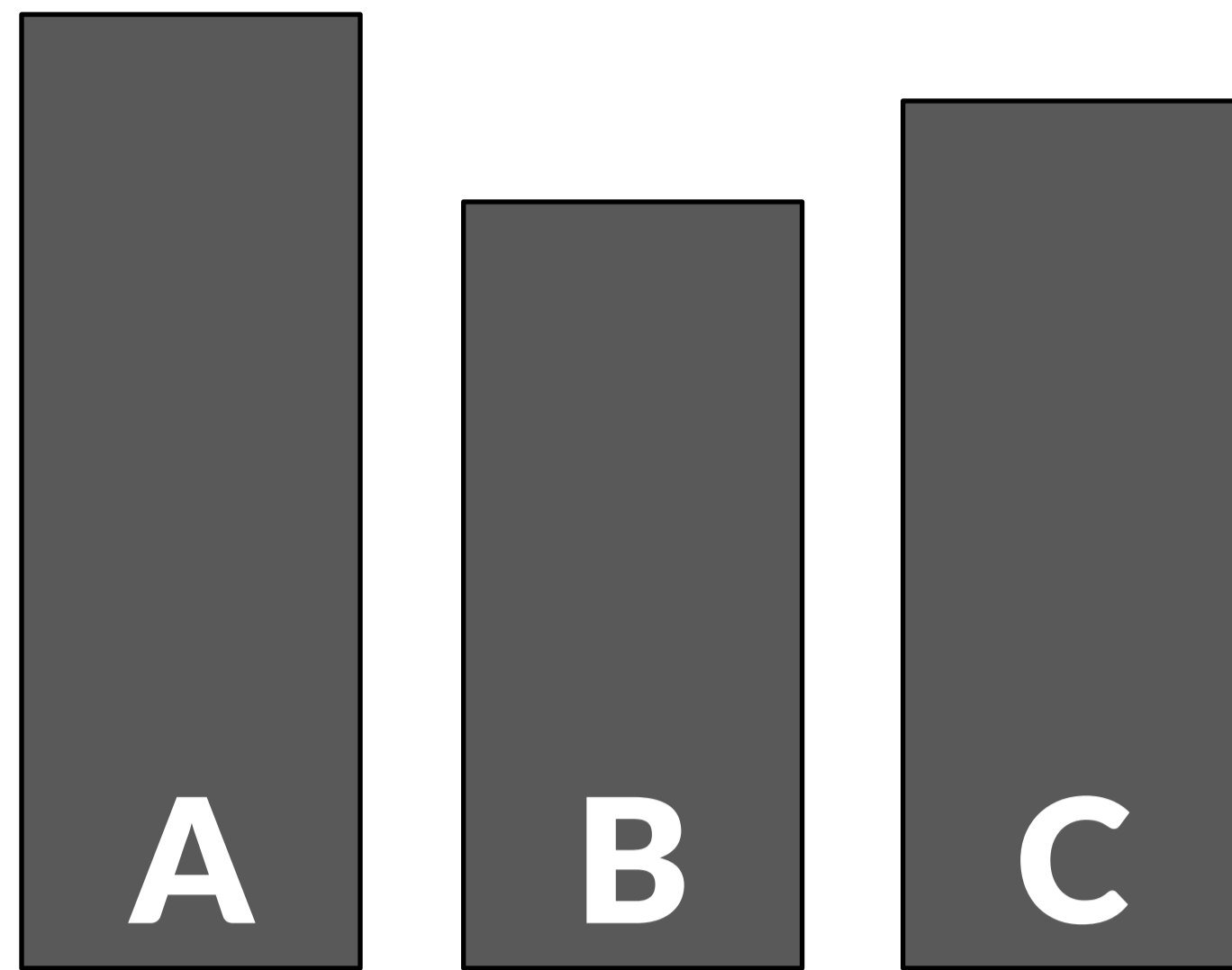

First, aggregate by

Then, aggregate by

Sort by
 Degree
 Cardinality
 Deviation

Aggregates

Row Height

Data
 Min Degree:

 Max Degree:

 Hide Empty Intersections

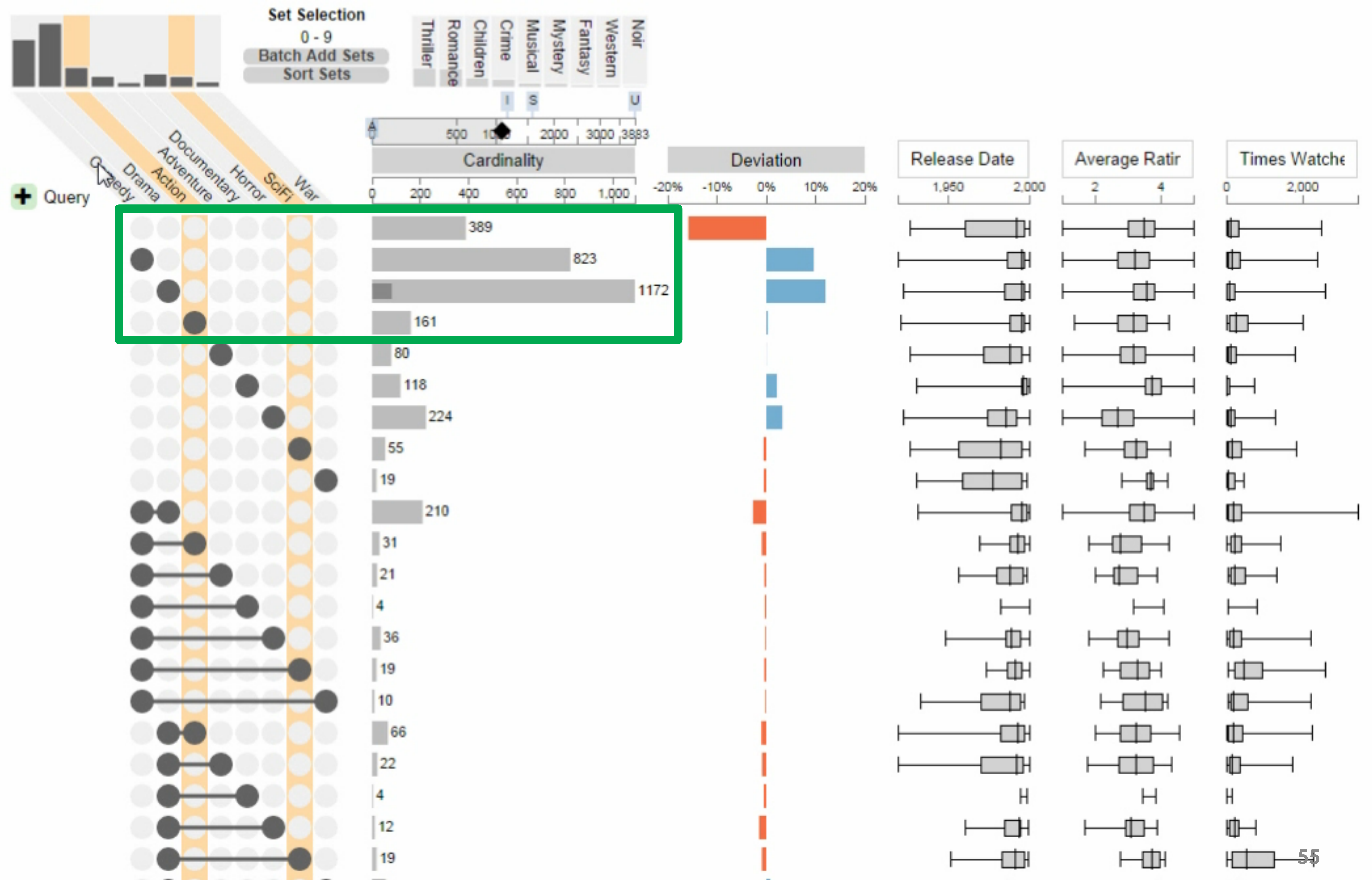

Dataset Information
 Name: Movies
 Genres
 # Sets: 17
 # Attributes: 6
 # Elements: 3883
 Author: grouplens
 Description:
 MovieLens ratings dataset, curated and filtered by Alsallakh.
 Source:
<http://grouplens.org/d...>

Aggregation

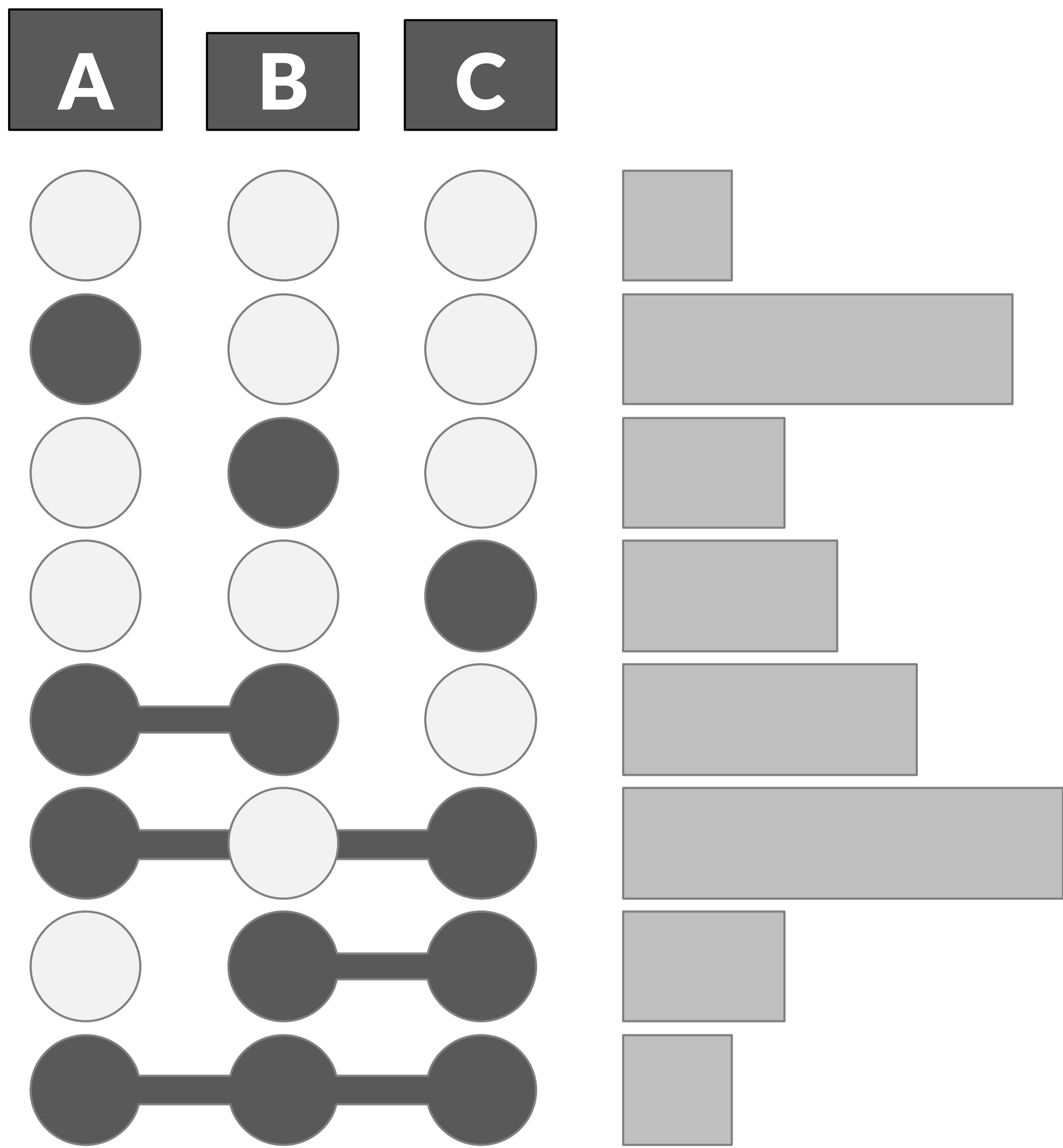

**Are many items shared between two sets?
Aggregate By: Degree**

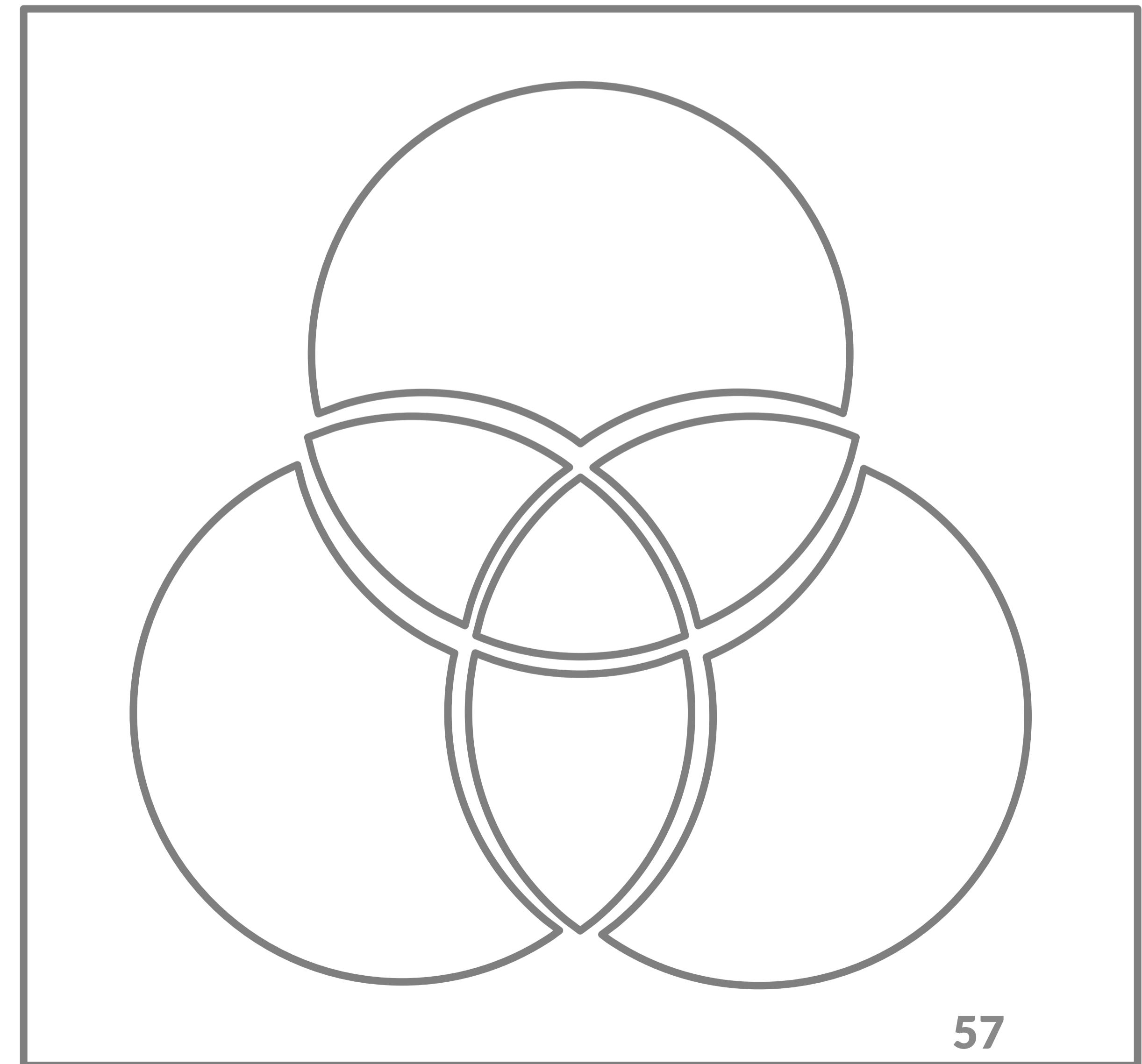

A **B** **C**

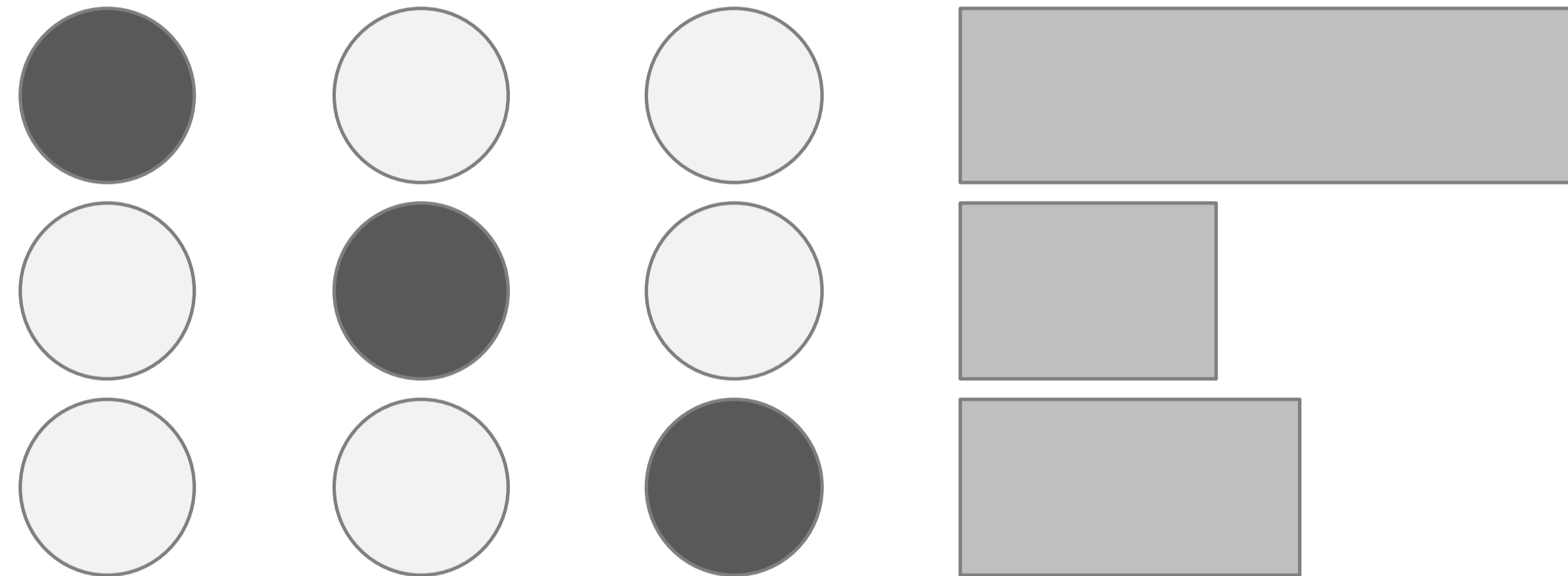
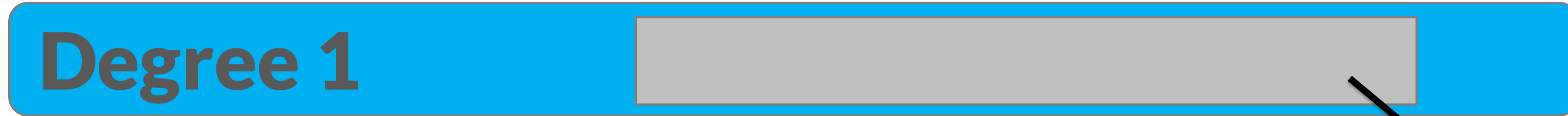
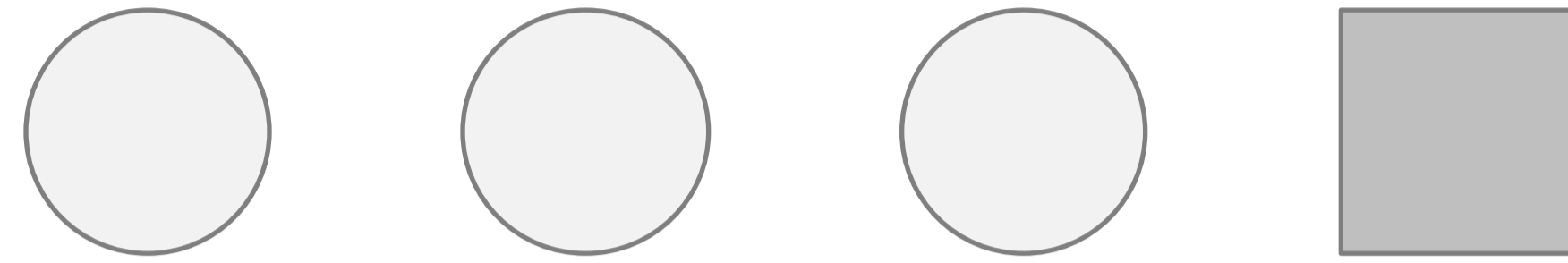
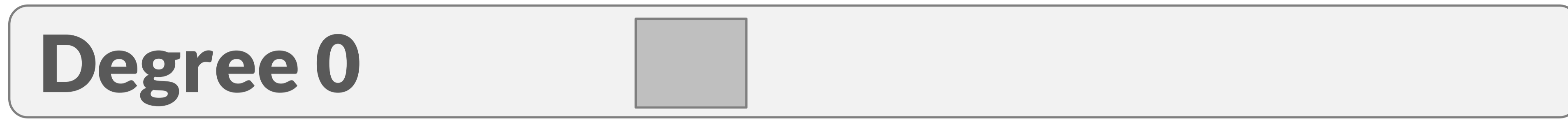

Sum of children

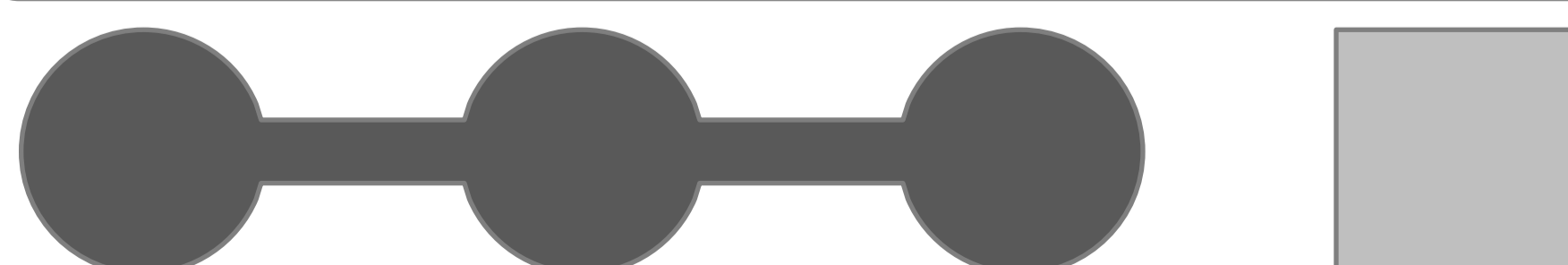
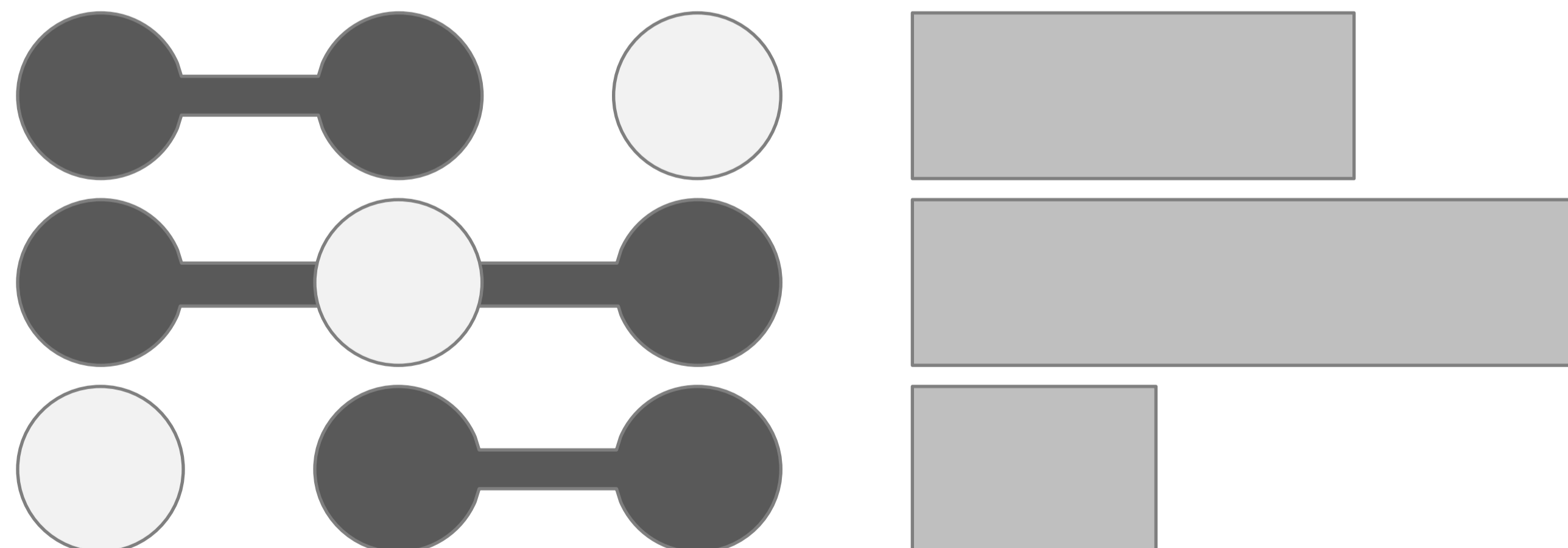

**Are many items shared between two sets?
Aggregate By: Degree**

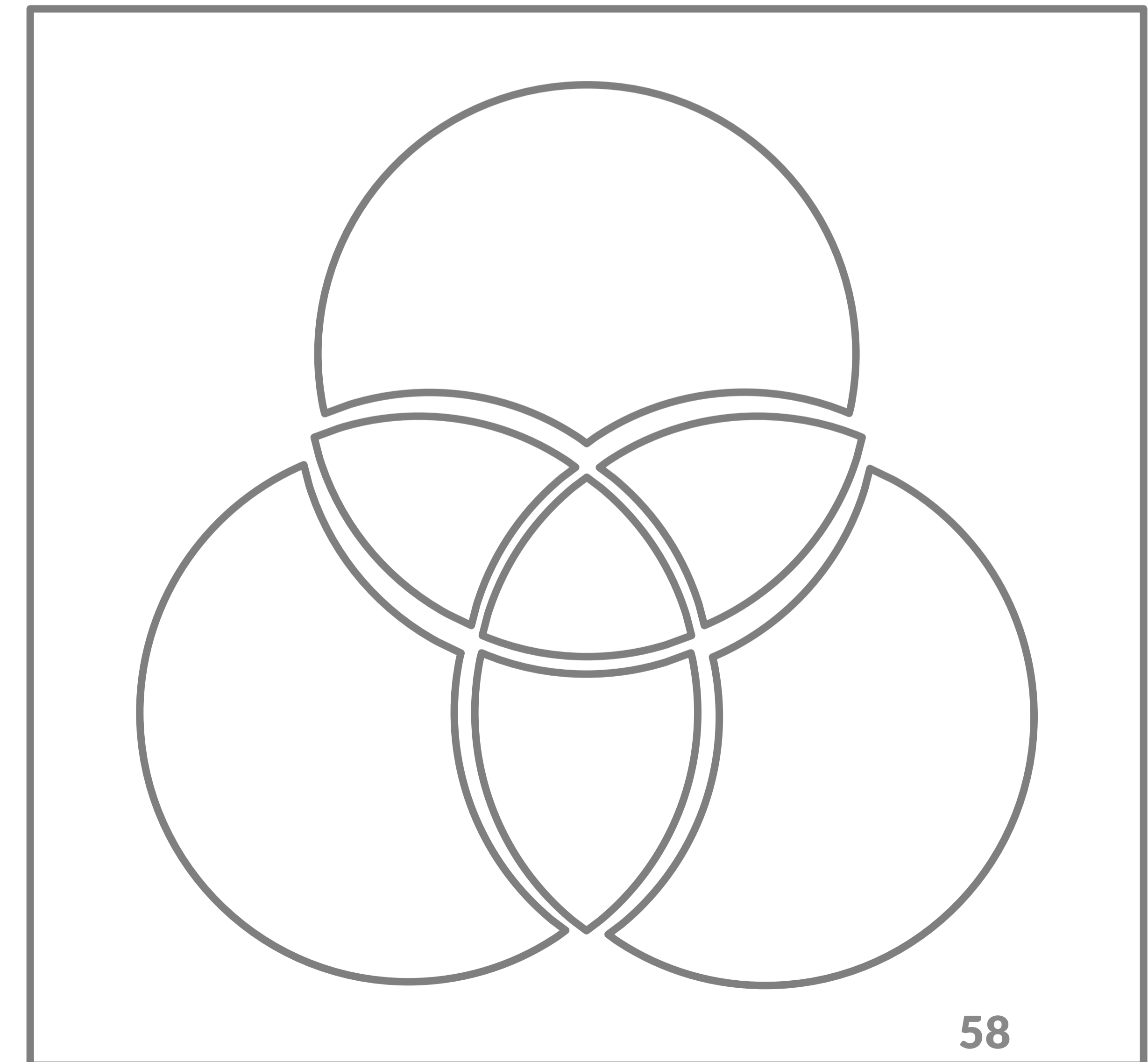

A **B** **C**

**How are the elements of 'B' distributed?
Aggregate By: Set**

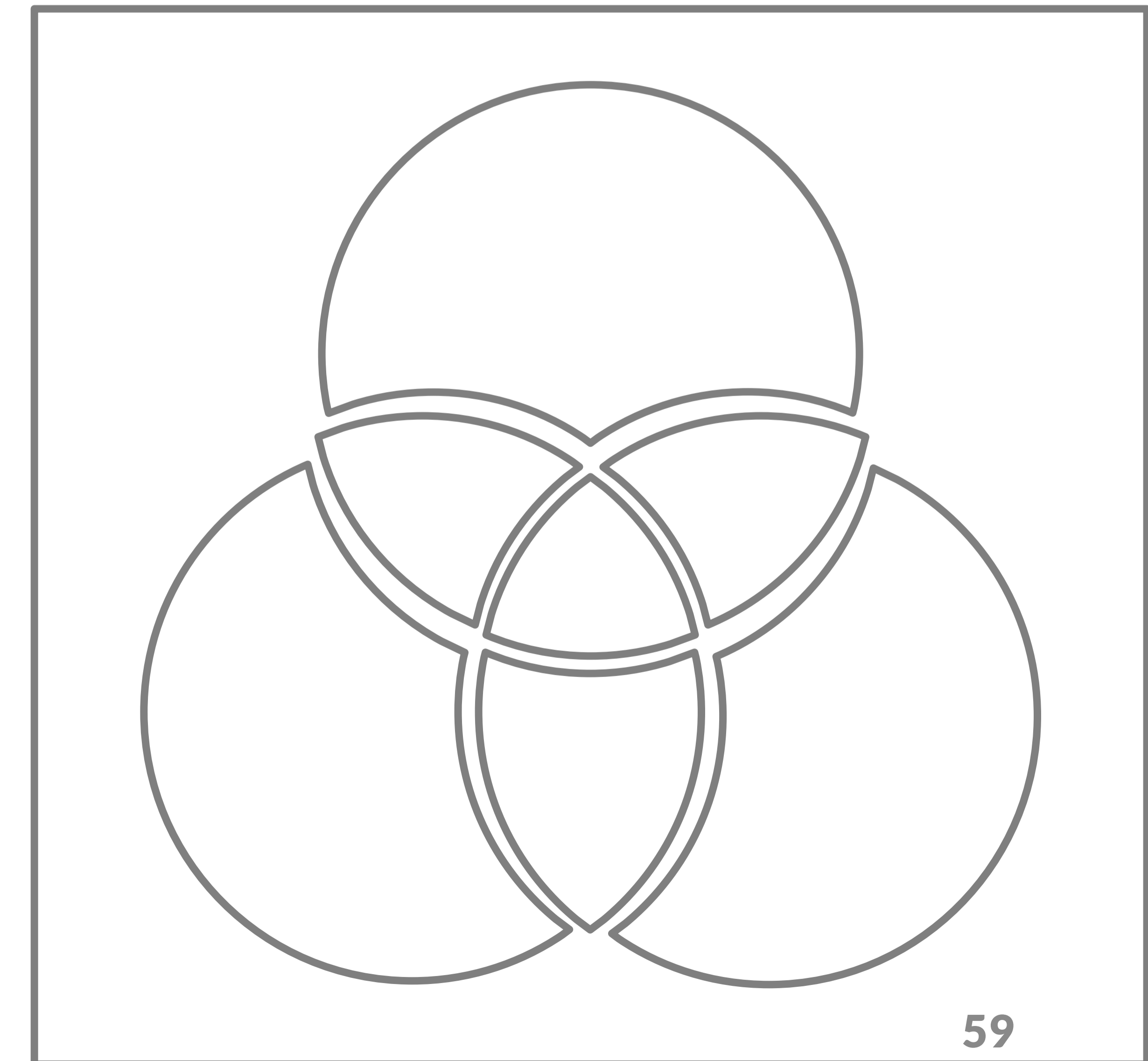
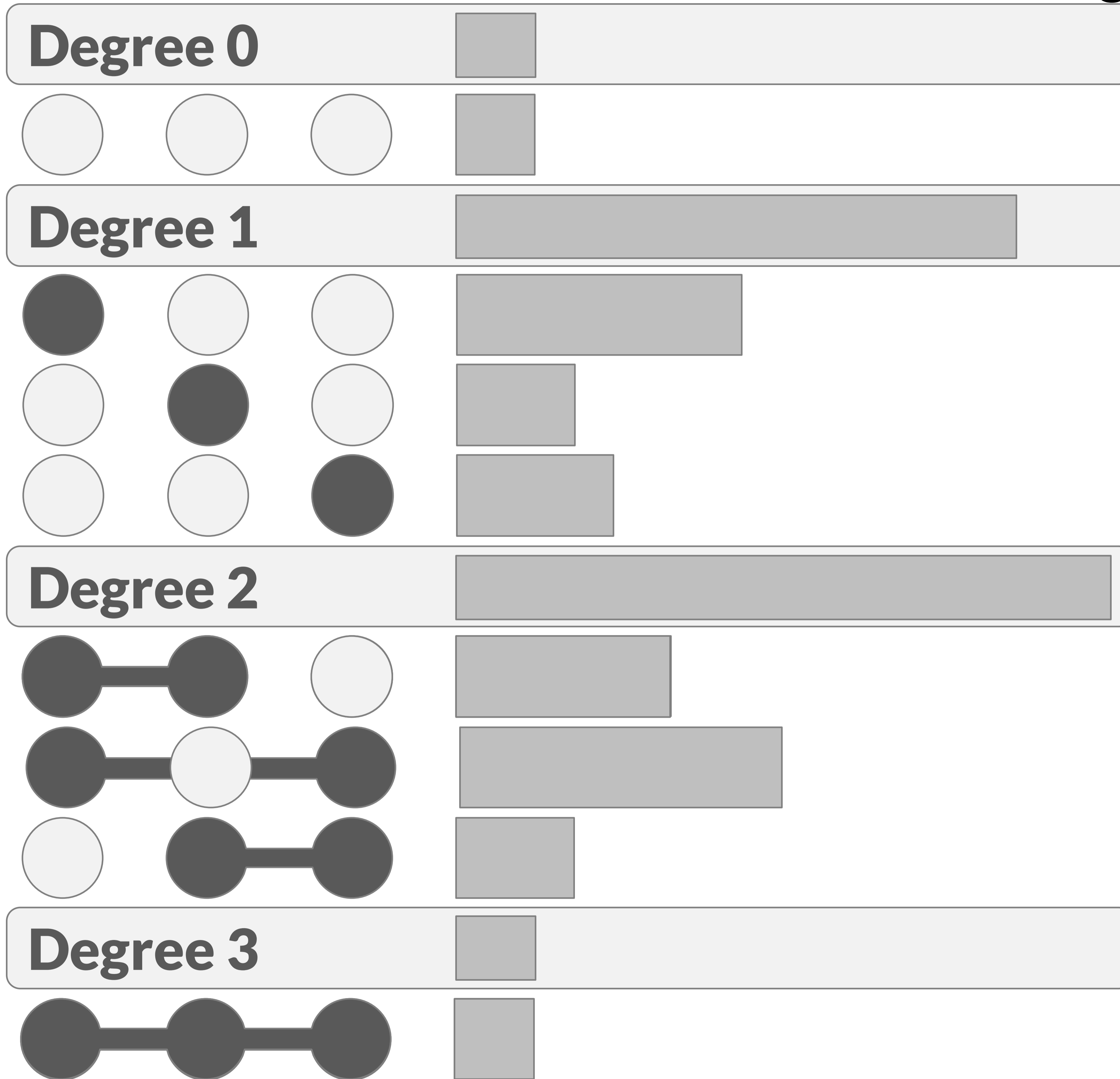

How are the elements of 'B' distributed? Aggregate By: Set

A **B** **C**

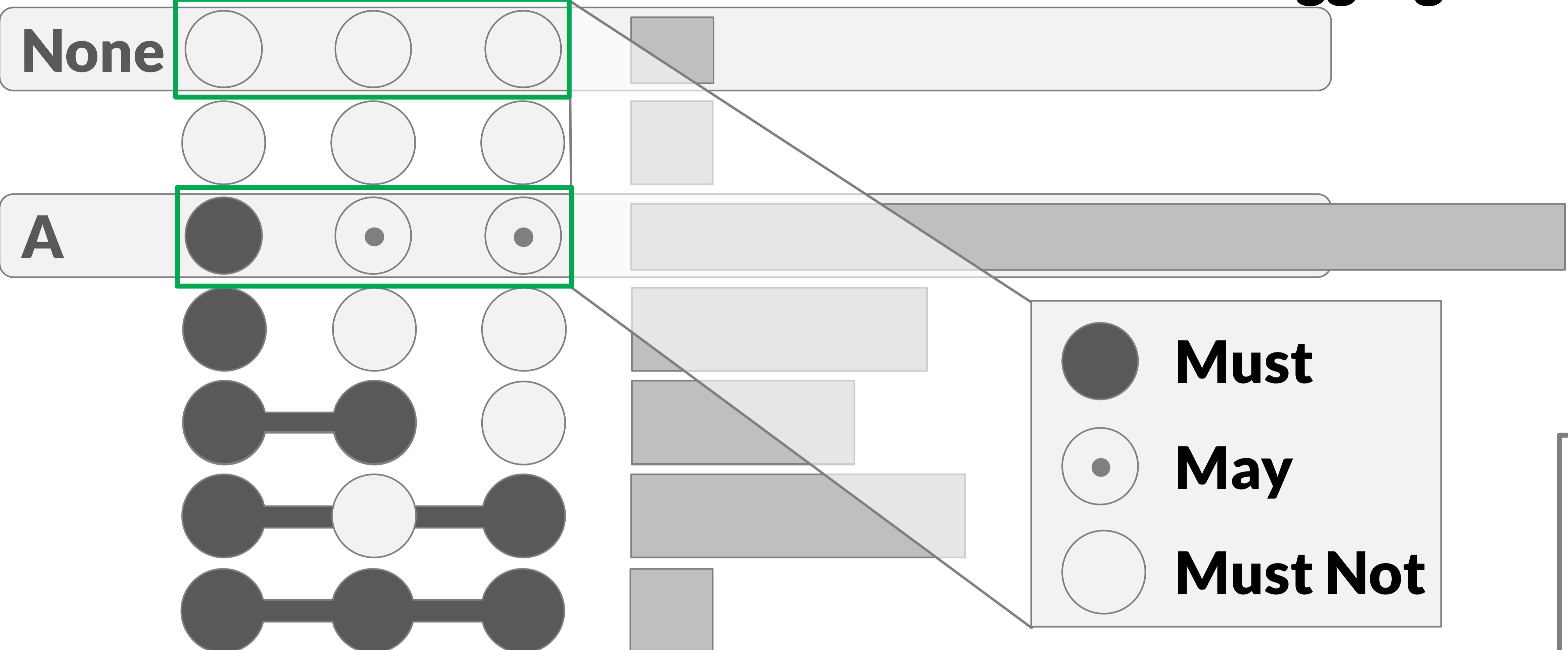

Must
 May
 Must Not

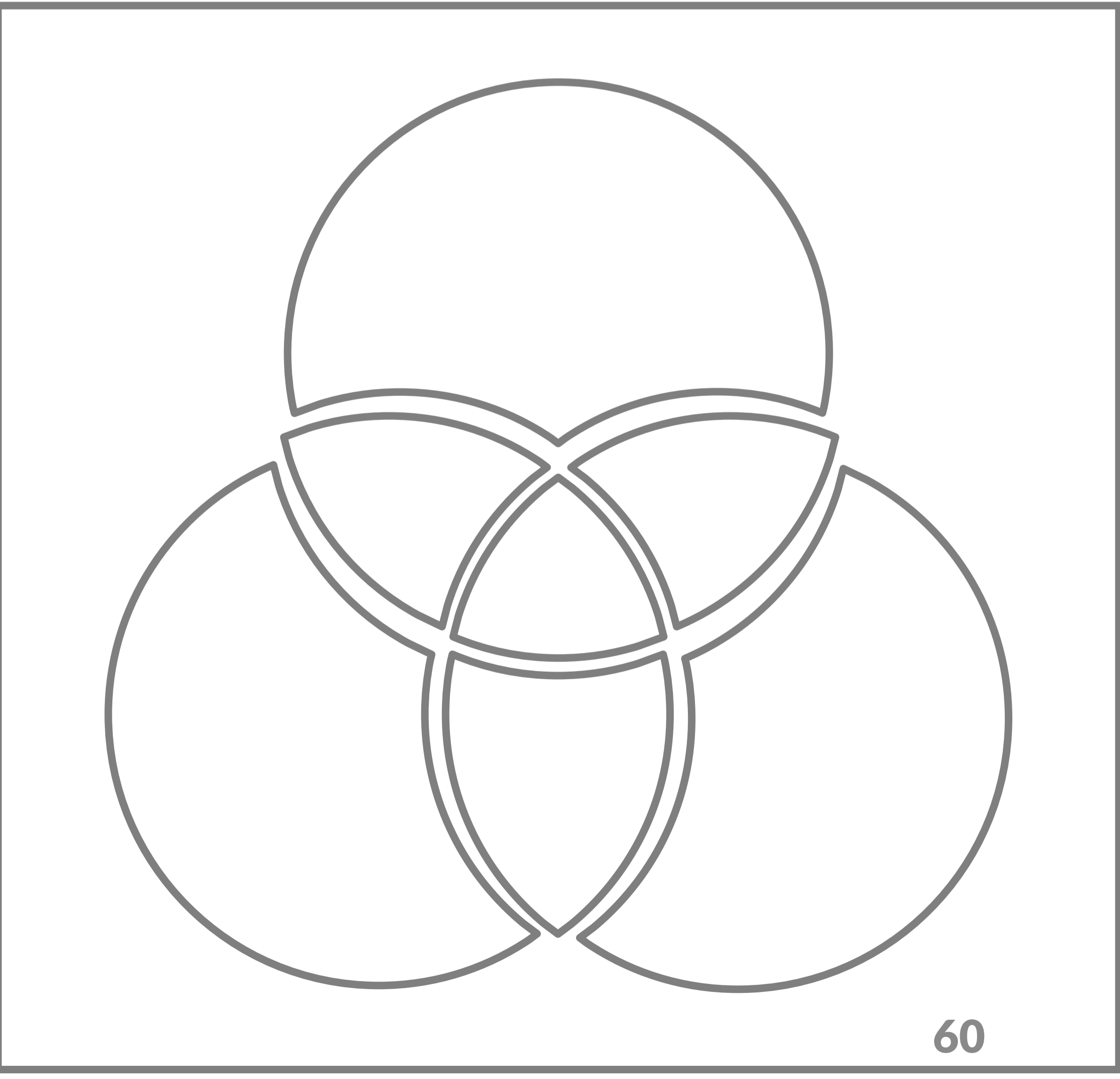
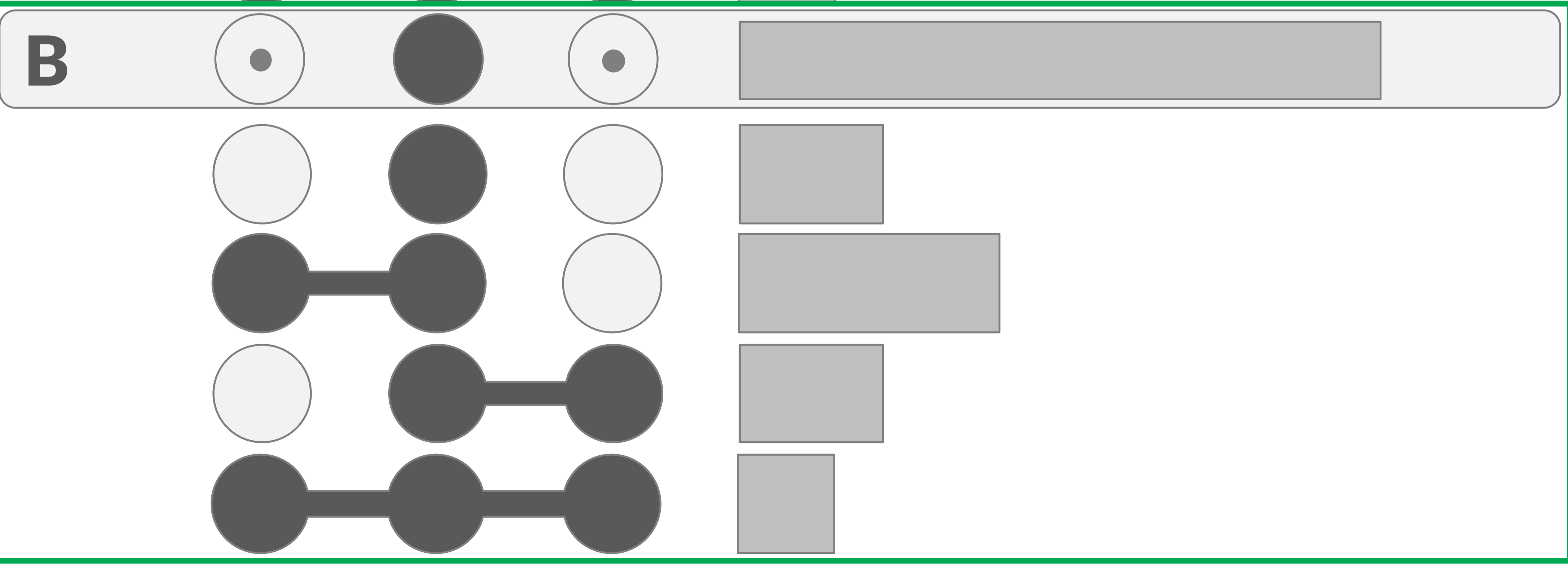

How are the elements of 'B' distributed? Aggregate By: Set

A **B** **C**

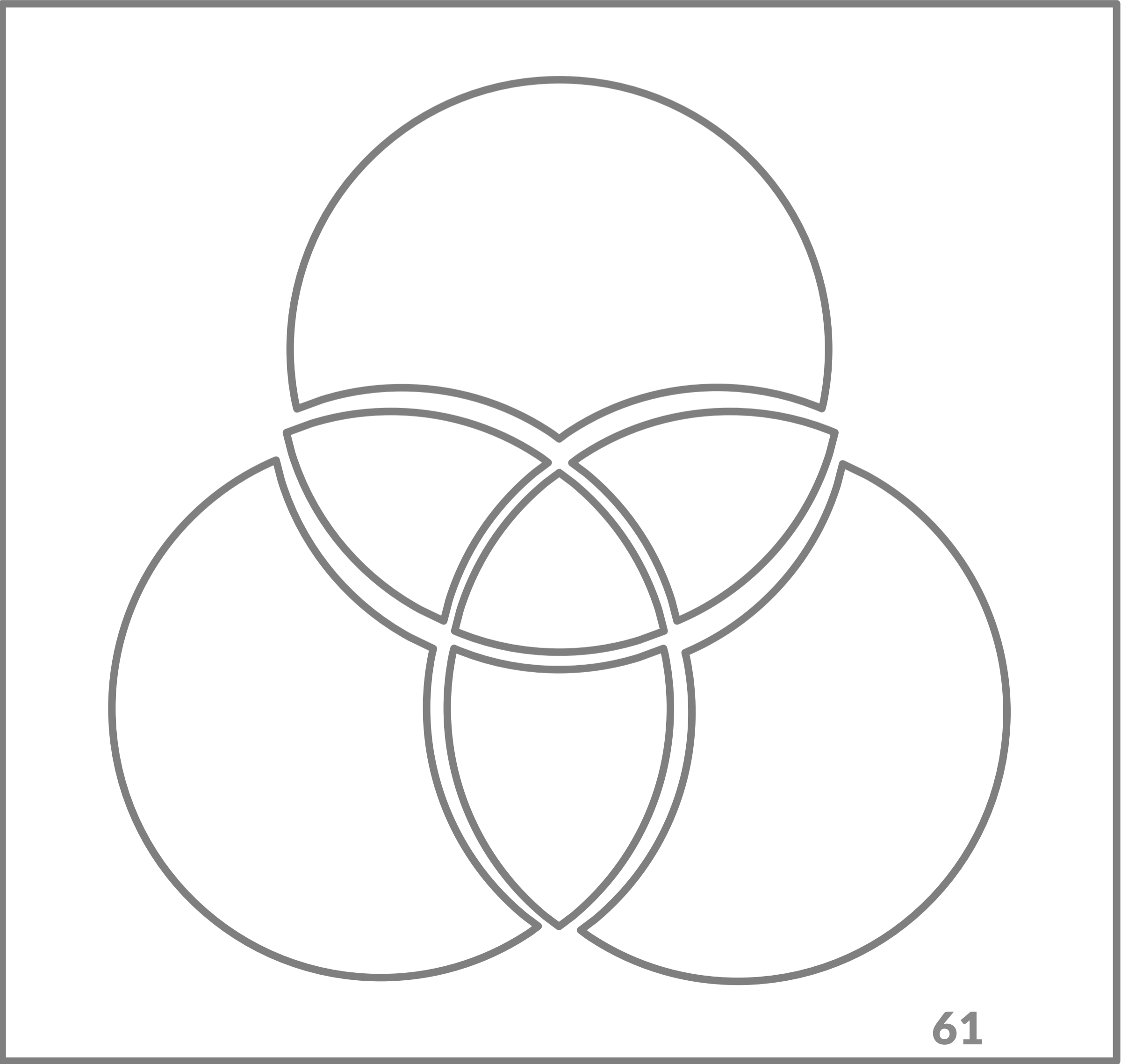
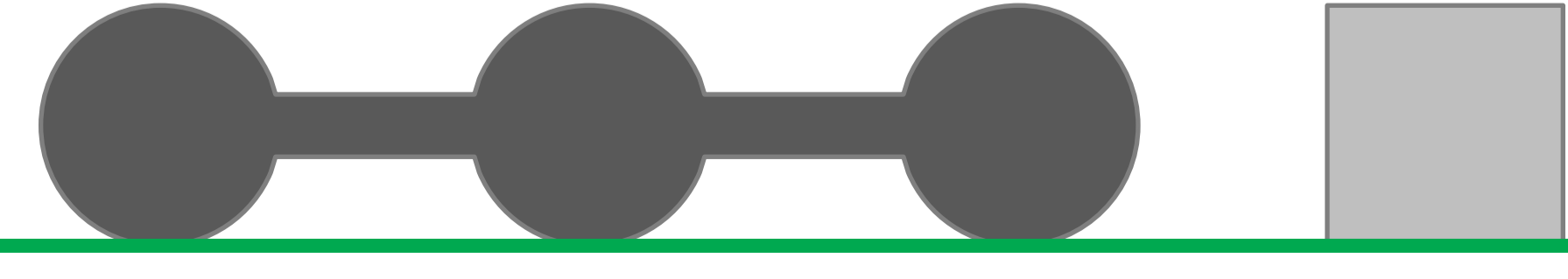
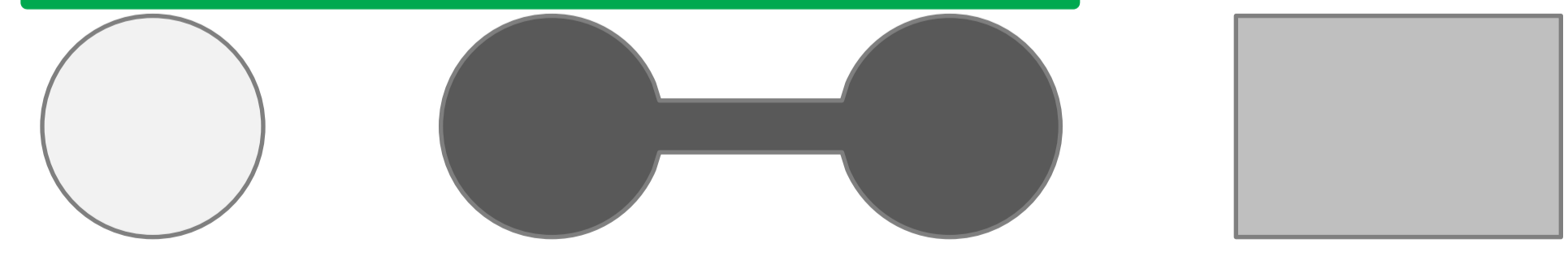
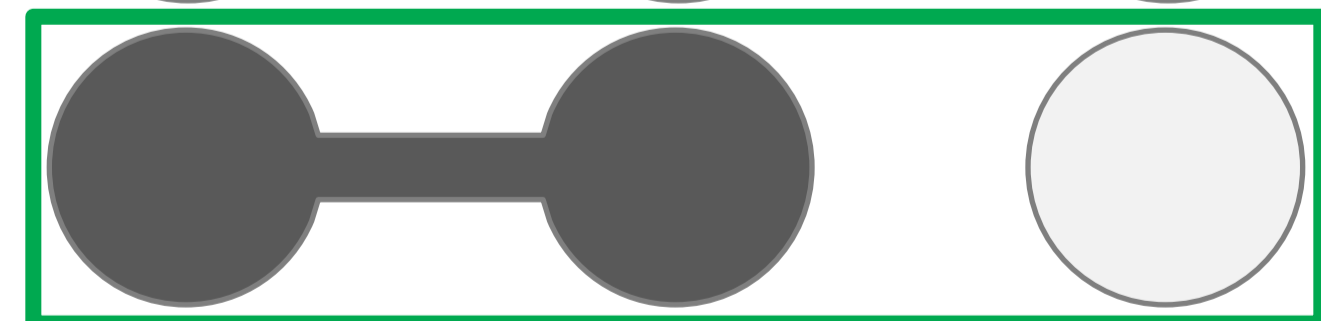
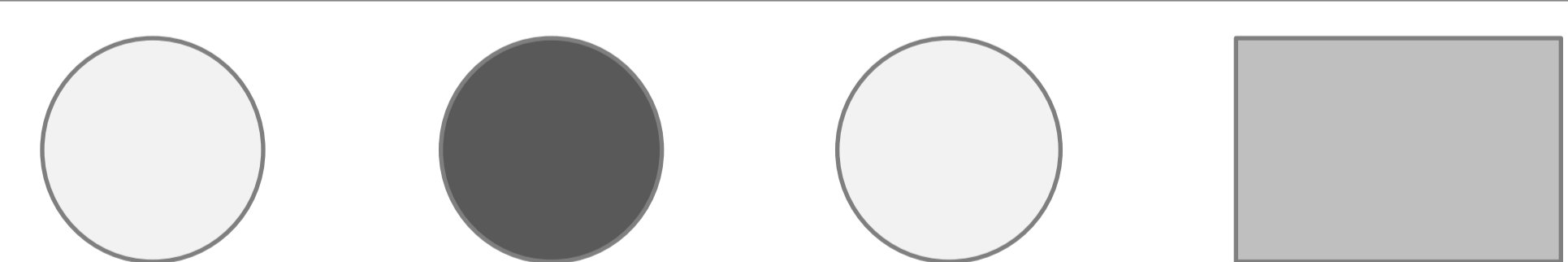
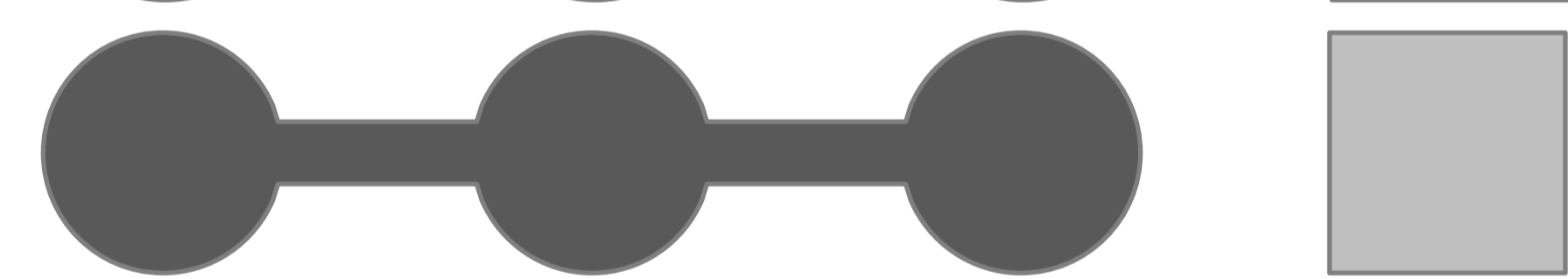
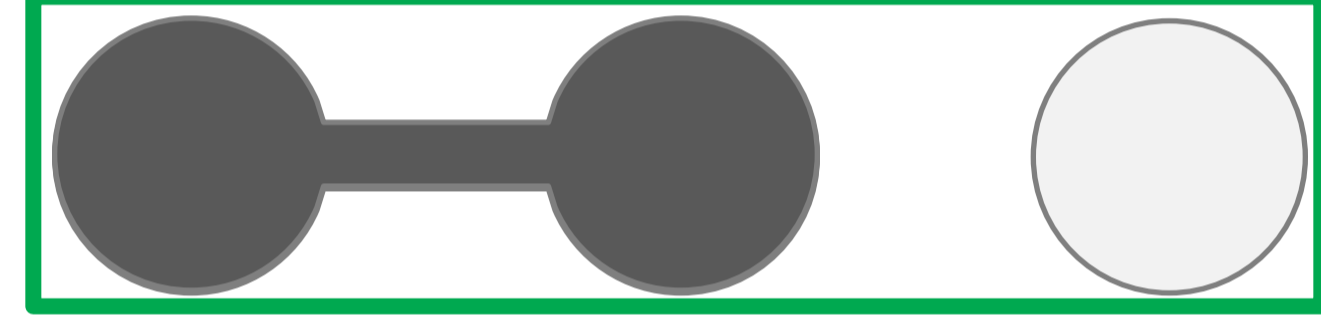
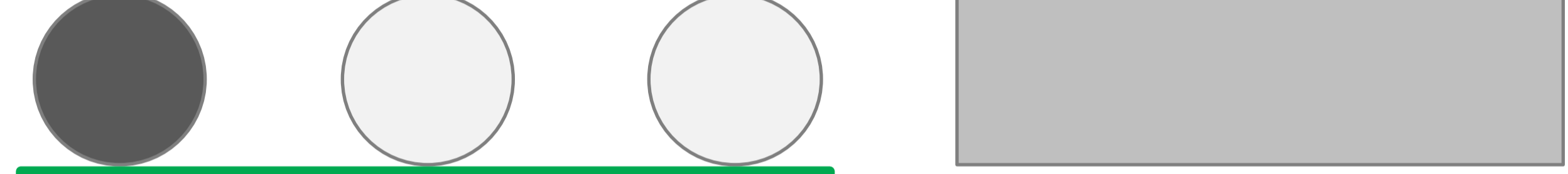
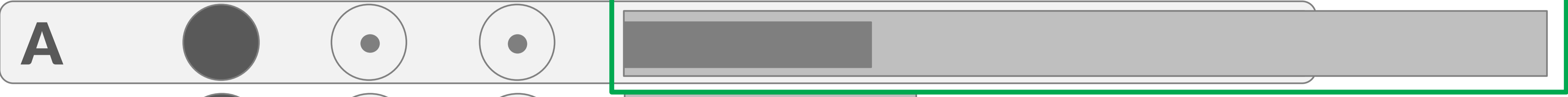
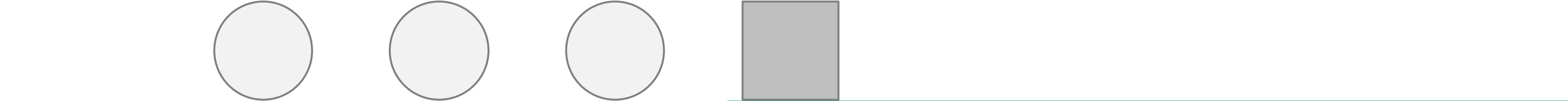

First, aggregate by
Degree

Then, aggregate by
Don't Aggregate

Sort by
 Degree
 Cardinality
 Deviation

Aggregates

Row Height
Large

Data
Min Degree: 0
Max Degree: 5
 Hide Empty Intersections

Dataset Information
Name: Movies
Genres
Sets: 17
Attributes: 6
Elements: 3883
Author: grouplens
Description: MovieLens ratings dataset, curated and filtered by Alsallakh.
Source: <http://grouplens.org/d..>

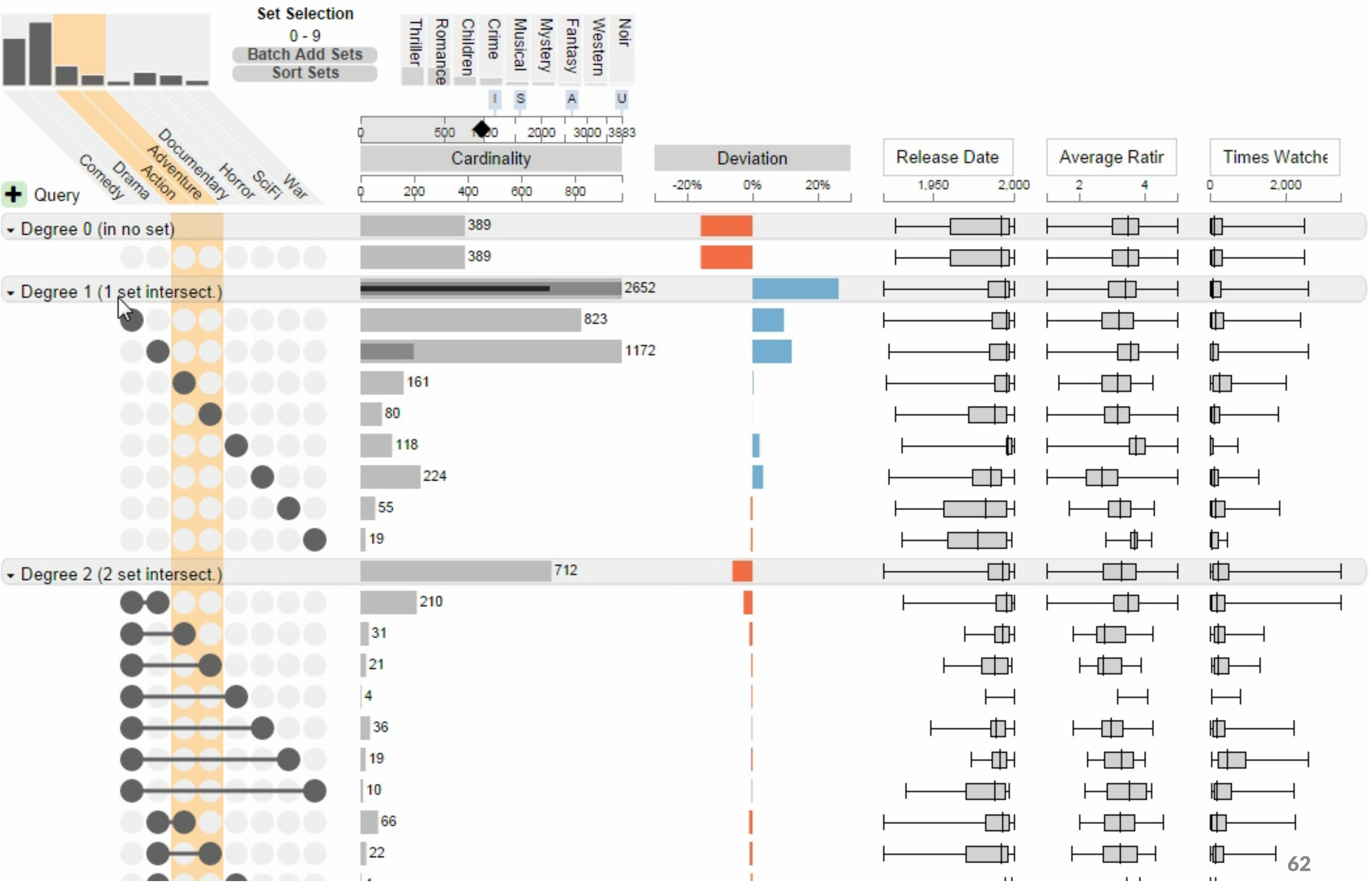

Queries

A B C

			Must
			May
			Must Not

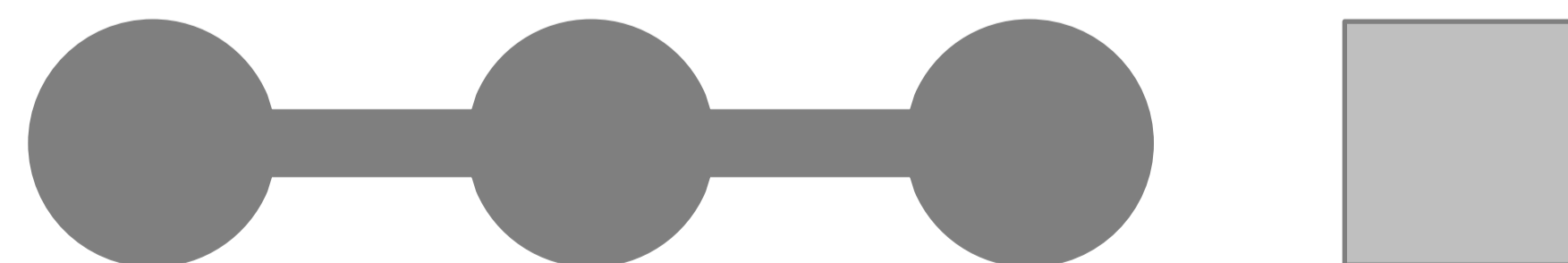
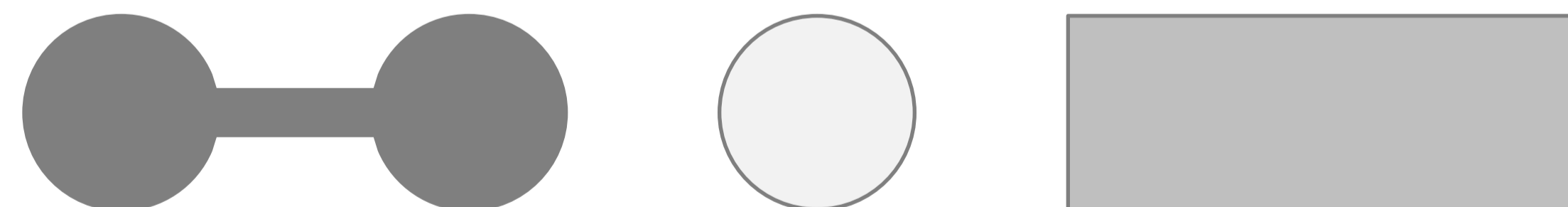

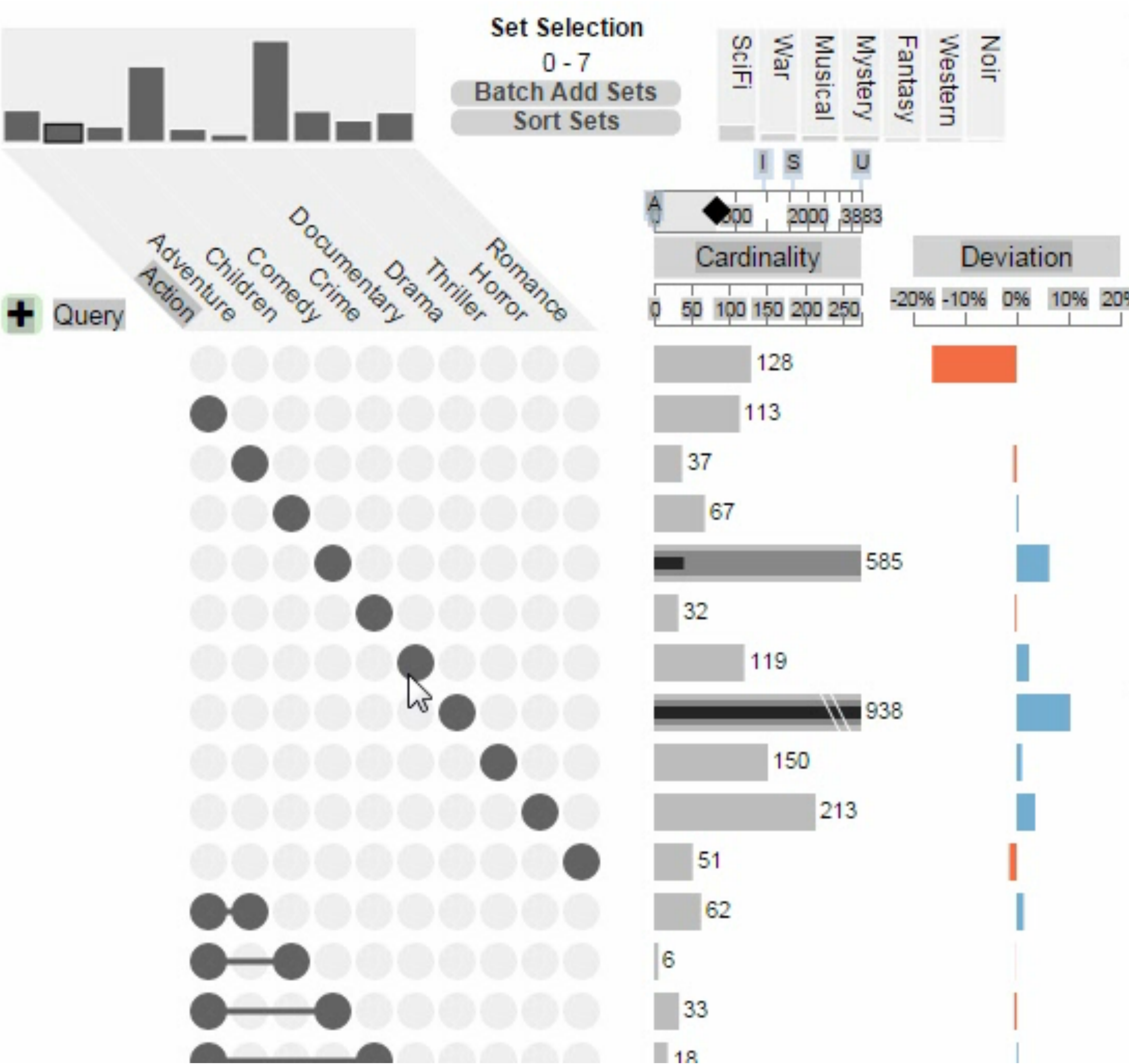

Element Visualizations

No visualizations configured. Click + button to add a new visualization.

+ Scatterplot [Navigation icons]

Element Queries

No queries. Click + button to add a new query.

+ [Add Query Button]

Query Filters

No active query.

Query Results

No active query.

Elements & Attributes

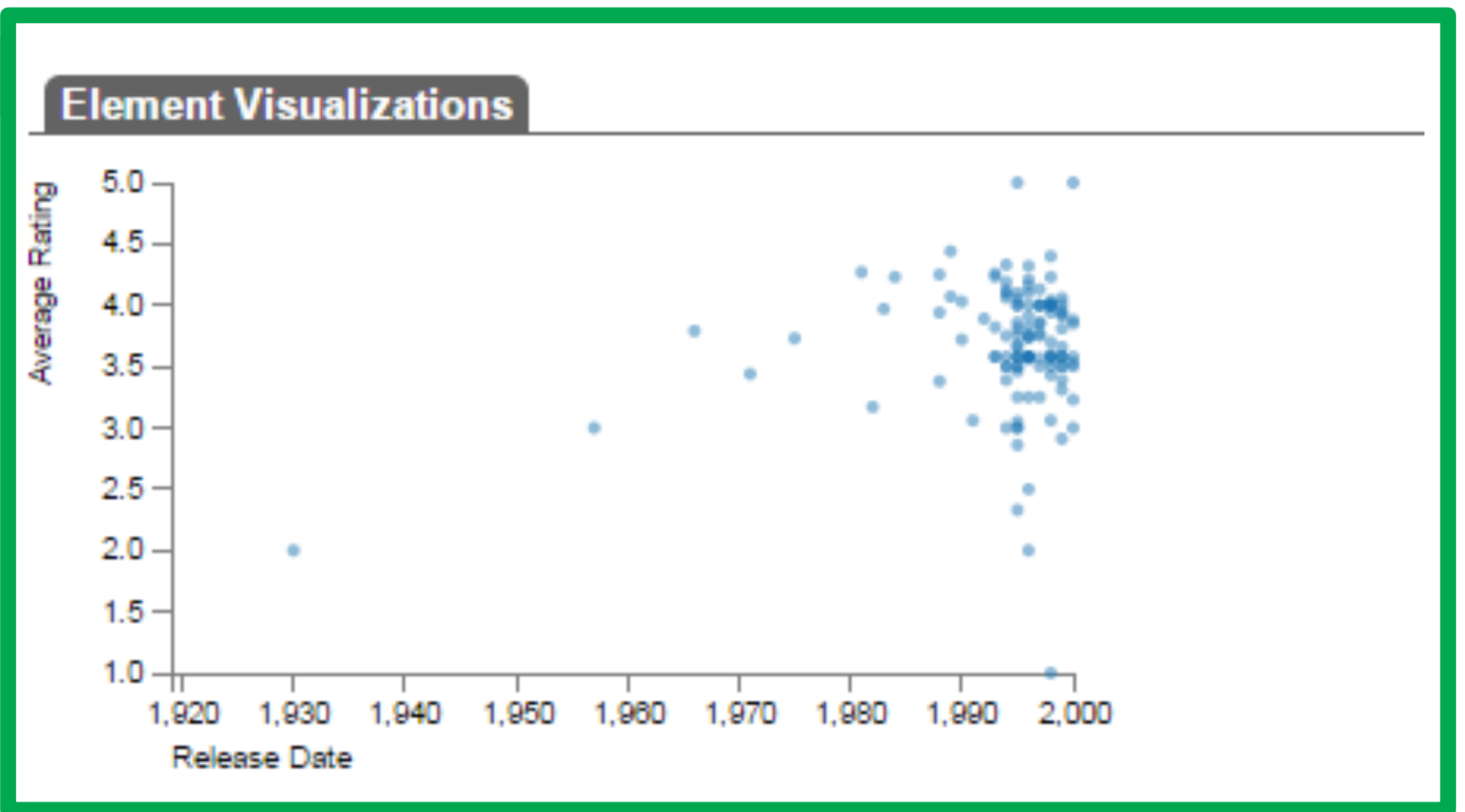
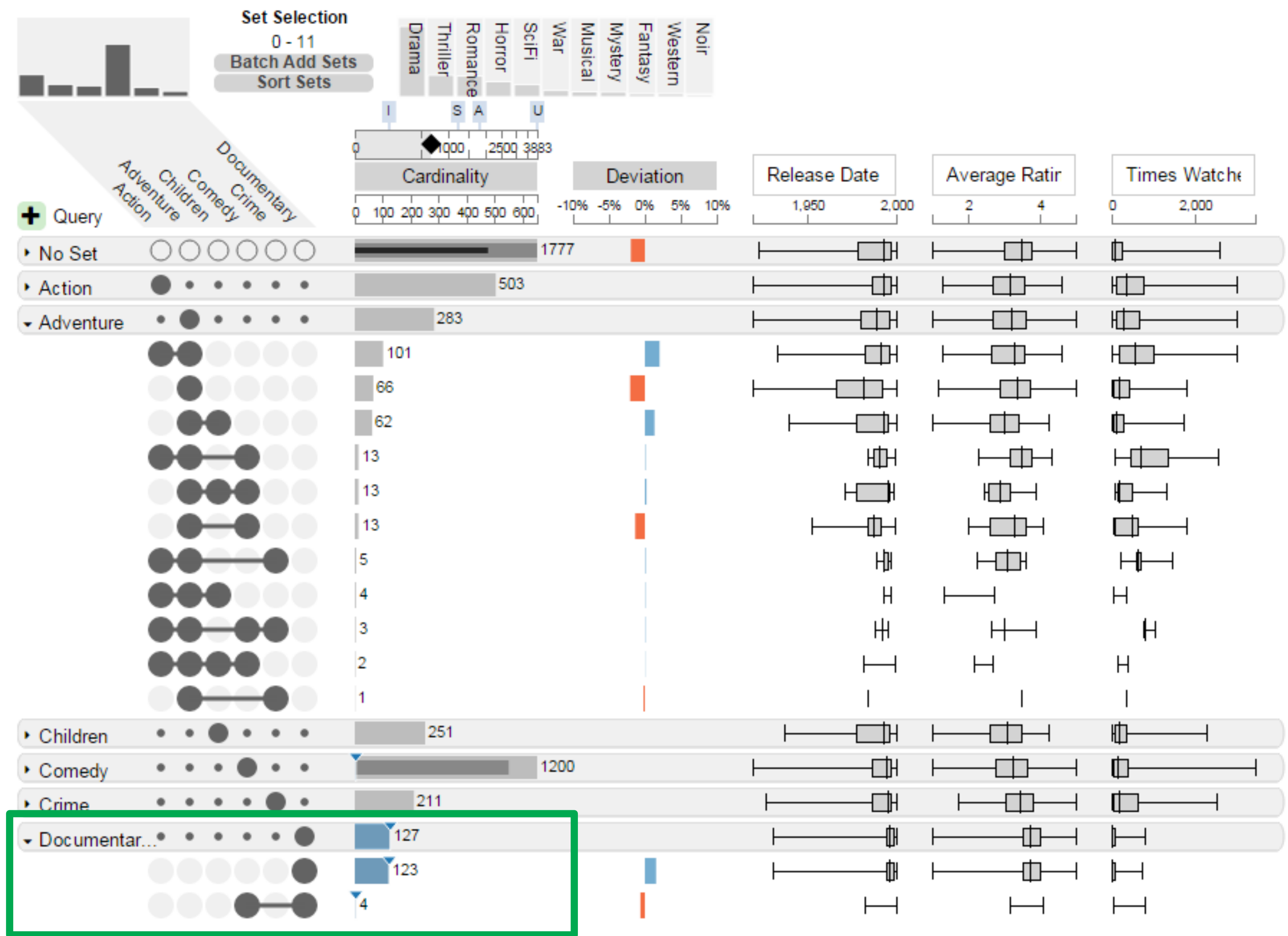

Scatterplot

Element Queries

- 127

Query Filters

- Subset | Sets
- Name Contains

Query Results

Name	Release Date
Across the Sea of Time (1995)	1995
Nico Icon (1995)	1995
Heidi Fleiss: Hollywood Madam (1995)	1995
Catwalk (1995)	1995
Anne Frank Remembered (1995)	1995
Jupiter's Wife (1994)	1994
Sonic Outlaws (1995)	1995
From the Journals of Jean Seberg (1995)	1995
Man of the Year (1995)	1995

How do documentaries compare to adventure movies?

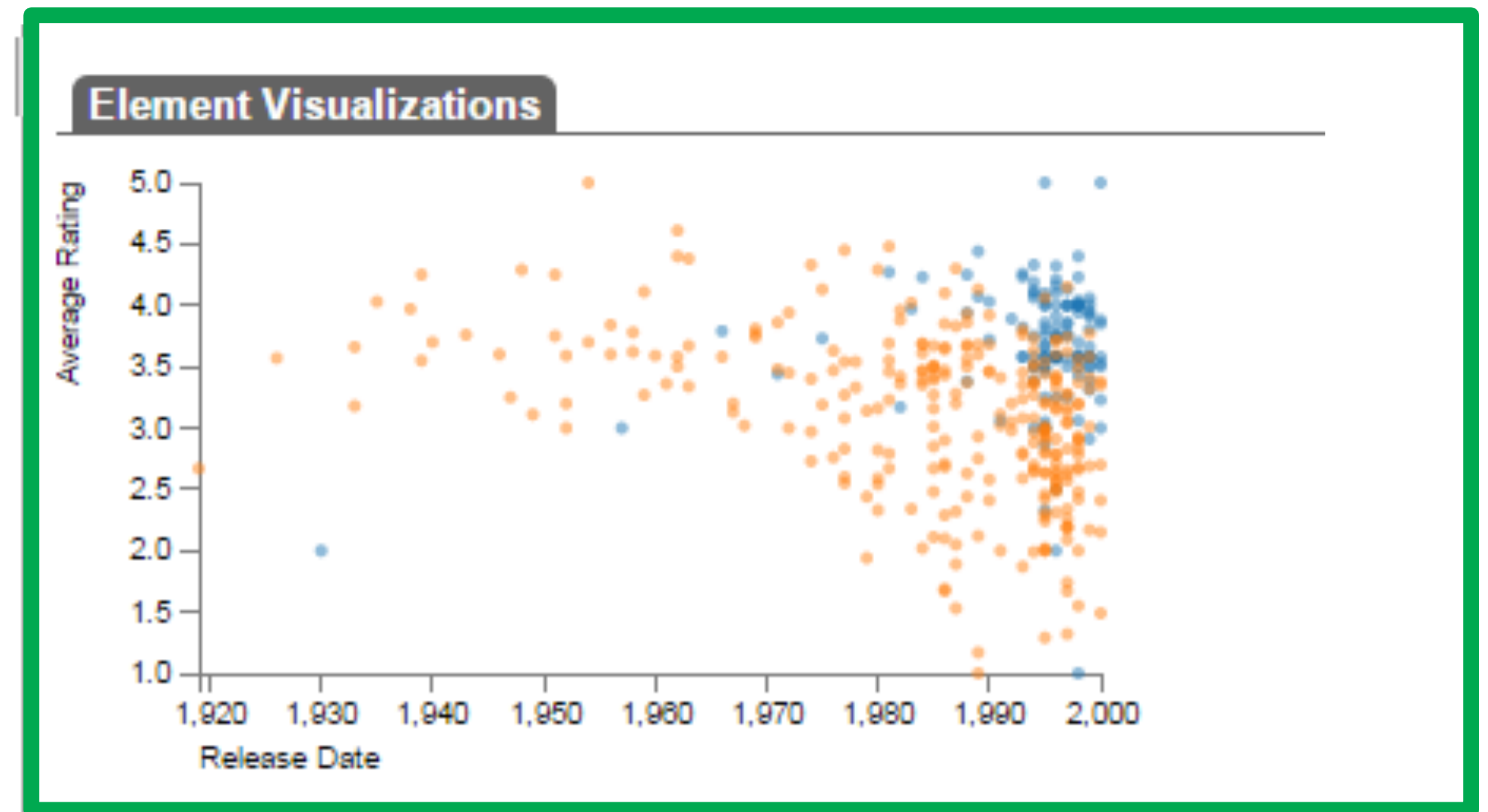
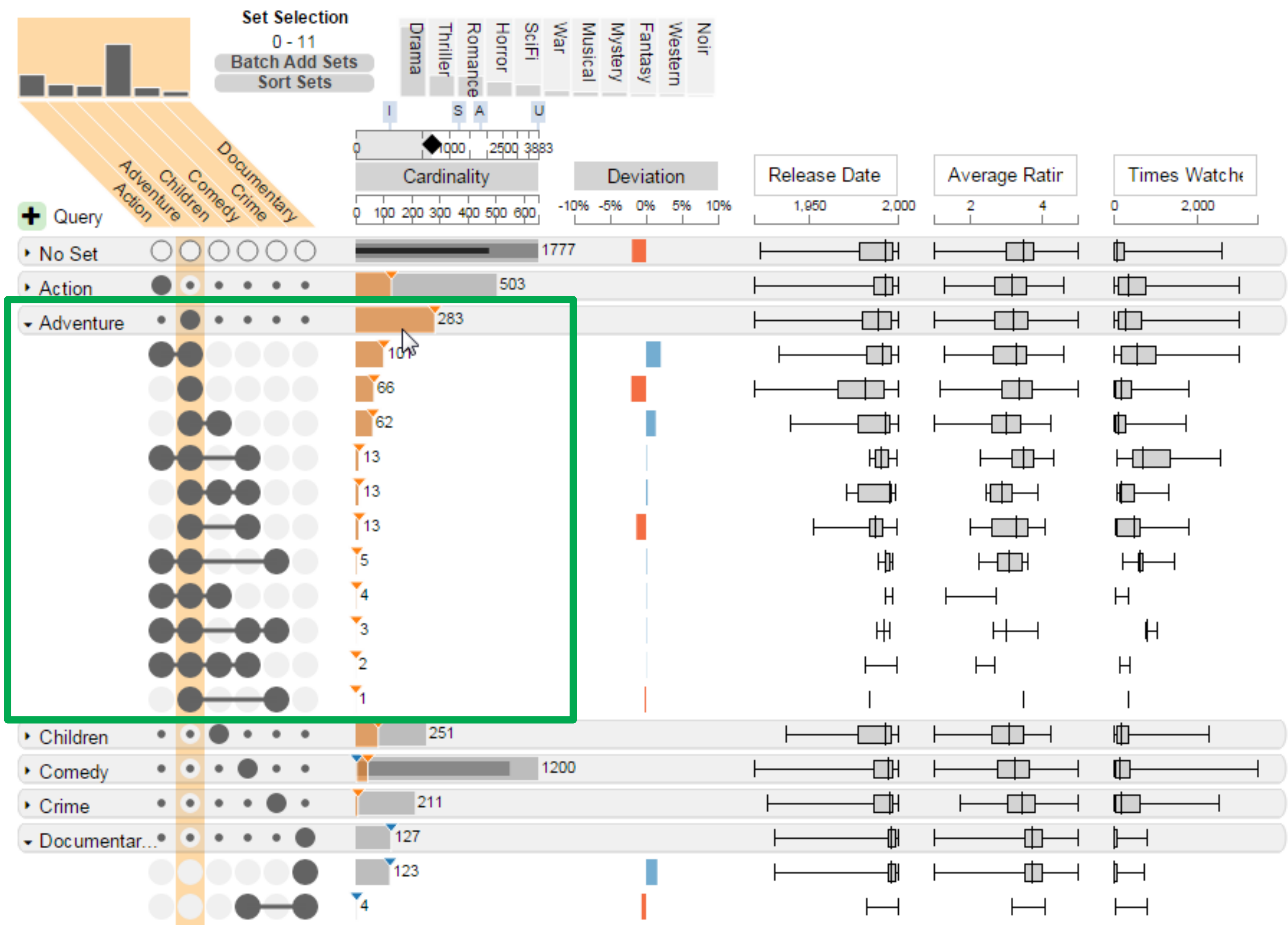

Scatterplot

Element Queries

127 283

Query Filters

Subset | Sets

Name Contains

Query Results

Name	Release Date
Jumanji (1995)	1995
Tom and Huck (1995)	1995
GoldenEye (1995)	1995
Cutthroat Island (1995)	1995
City of Lost Children, The (1995)	1995
Wings of Courage (1995)	1995
Mortal Kombat (1995)	1995
Kids of the Round Table (1995)	1995
Indian in the Cupboard, The (1995)	1995
White Squall (1996)	1996
Muppet Treasure Island (1996)	1996

How do documentaries compare to adventure movies?

Applications

Applications

Genetics

Economics

Pharmacology

Social Networks



Scalability

Comfortable: ~15 sets

Possible: ~40 sets

**Scales with the number of
non-empty intersections**

Most datasets are sparse

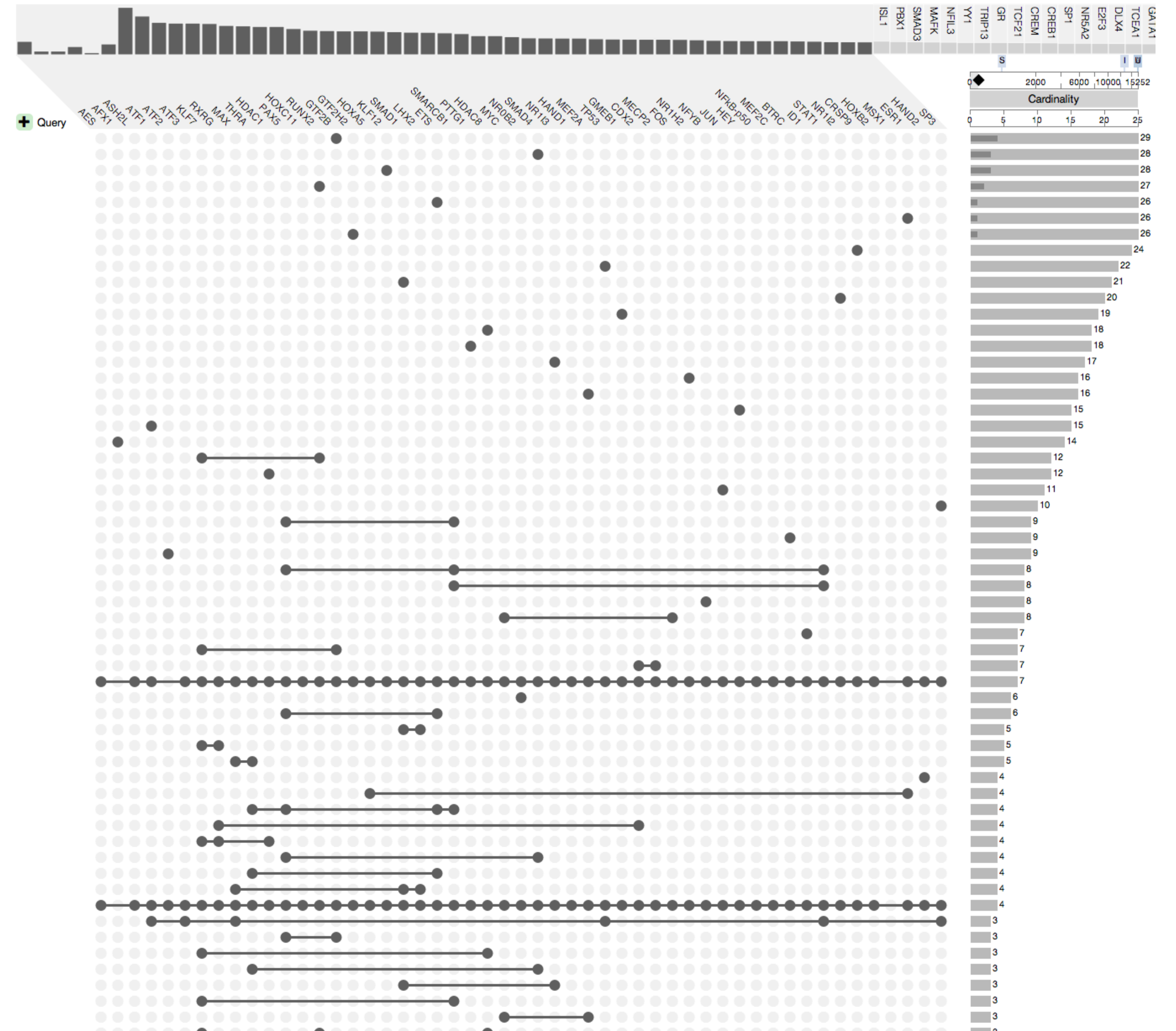

Deviation Measure

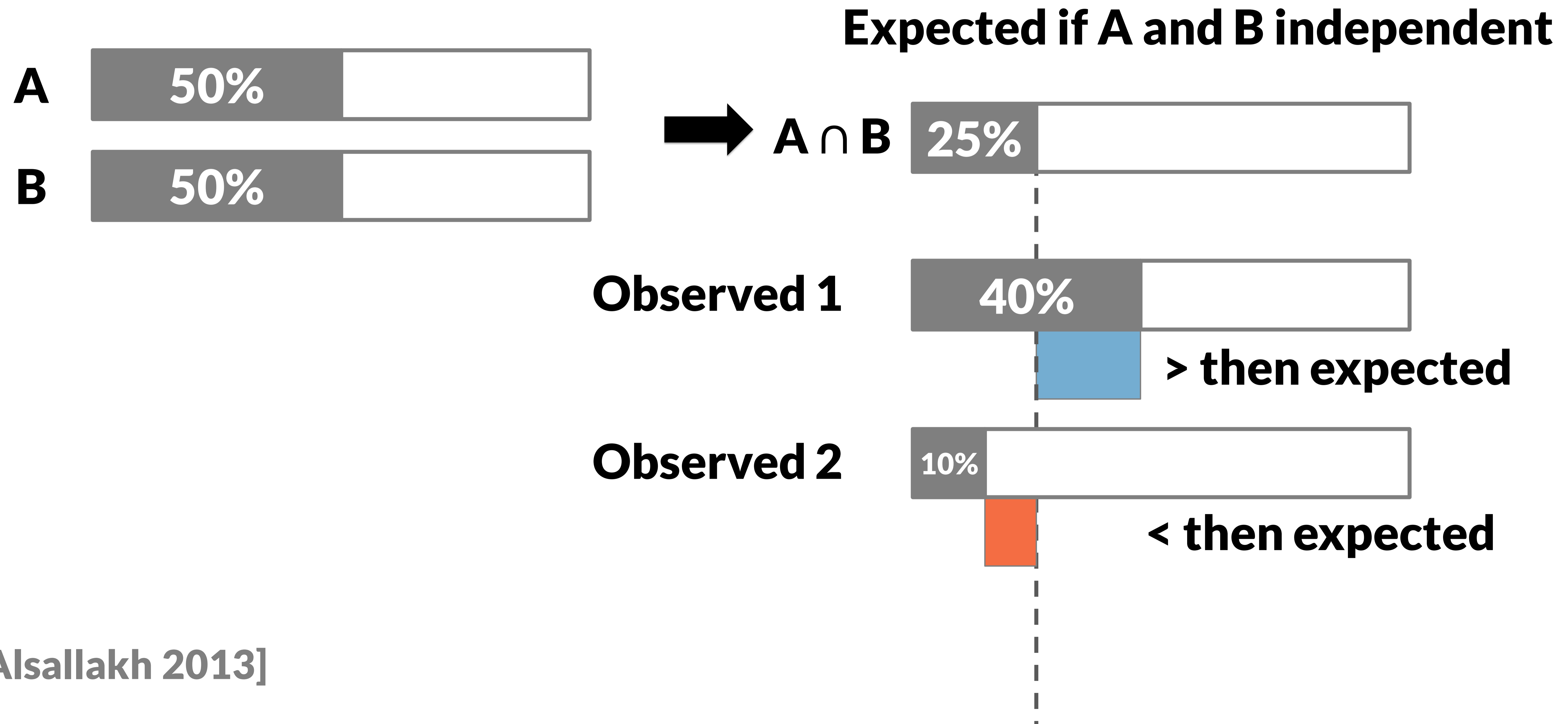

<http://vcg.github.io/upset>

[Part I, BioVis '12]

Best Paper Award

[Part I, BMC Bioinf. '13]

[Lex, InfoVis '13]

Pathways

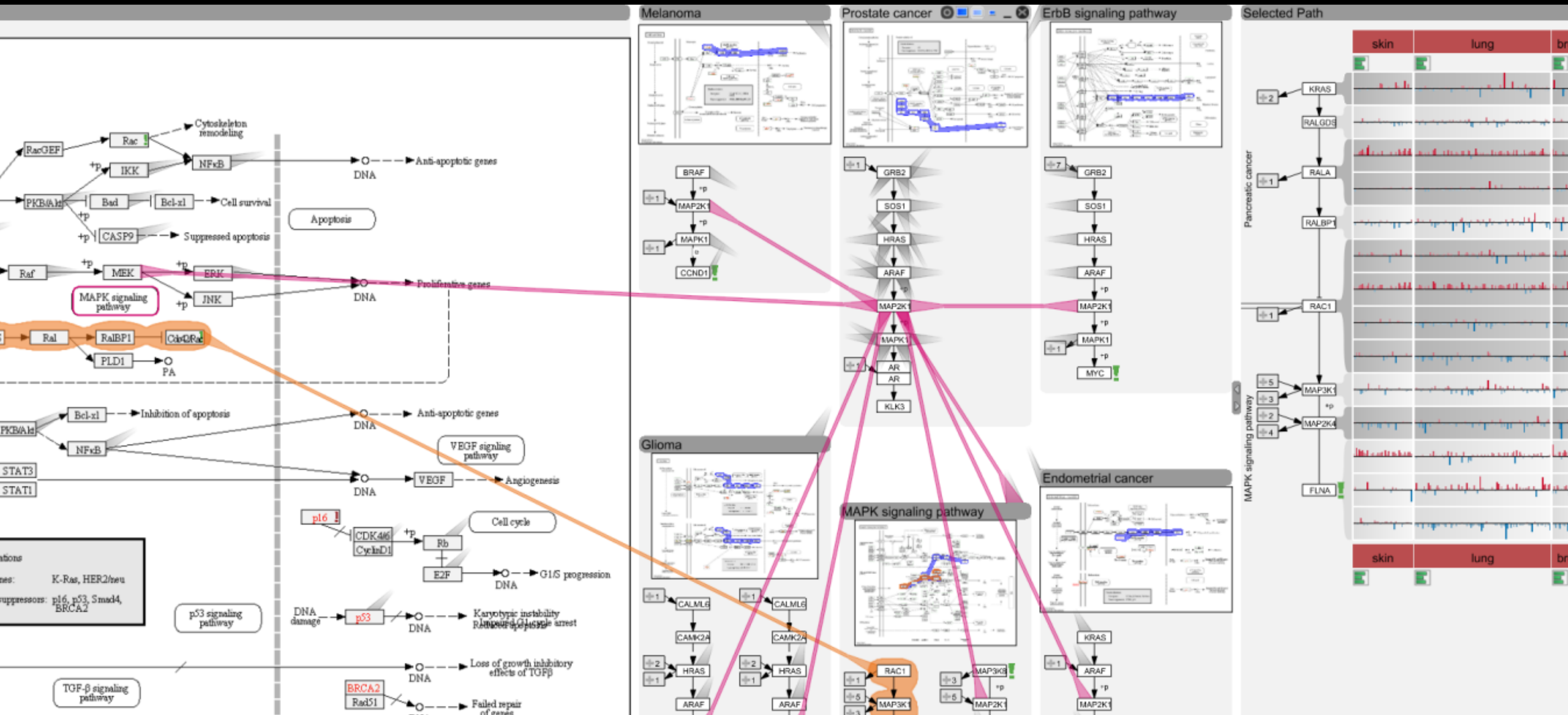

Publications

Alexander Lex, Christian Partl, Denis Kalkofen, Marc Streit, Anne Mai Wasserman, Samuel Gratzl, Dieter Schmalstieg and Hanspeter Pfister

Entourage: Visualizing Relationships between Biological Pathways using Contextual Subsets

IEEE TVCG (InfoVis '13), 2013

Christian Partl, Alexander Lex, Marc Streit, Denis Kalkofen, Karl Kashofer and Dieter Schmalstieg
enRoute: Dynamic Path Extraction from Biological Pathway Maps for Exploring Heterogeneous Experimental Datasets

BMC Bioinformatics, 2013

Christian Partl, Alexander Lex, Marc Streit, Denis Kalkofen, Karl Kashofer, Dieter Schmalstieg
enRoute: Dynamic Path Extraction from Biological Pathway Maps for In-Depth Experimental Data Analysis

BioVis, 2012

Best Paper Award



KEGG PATHWAY Database

Wiring diagrams of molecular interactions, reactions, and relations

KEGG2 PATHWAY BRITE MODULE KO GENOME GENES LIGAND DISEASE DRUG DBGET

Select prefix: map Organism Enter keywords: [] Go Help

[New maps | Update history]

Pathway Maps

KEGG PATHWAY is a collection of manually drawn pathway maps representing our knowledge on the molecular interaction and reaction networks for:

1. Metabolism

Global/overview Carbohydrate Energy Lipid Nucleotide Amino acid Other amino Glycan Cofactor/vitamin Terpenoid/PK Other secondary metabolite Xenobiotics Chemical structure

2. Genetic Information Processing

3. Environmental Information Processing

4. Cellular Processes

5. Organismal Systems

6. Human Diseases

and also on the structure relationships (KEGG drug structure maps) in:

7. Drug Development

Pathway Mapping

KEGG PATHWAY mapping is the process to map molecular datasets, especially large-scale datasets in genomics, transcriptomics, proteomics, and metabolomics, to the KEGG pathway maps for biological interpretation of higher-level systemic functions.

- Search Pathway - basic pathway mapping tool
Search&Color Pathway - advanced pathway mapping tool
Color Pathway - selected pathway map coloring tool

1. Metabolism

1.0 Global and overview maps

Table with 3 columns: Pathway Name, [KEGG Atlas], and KEGG modules/reaction modules. Includes entries like Metabolic pathways, Biosynthesis of secondary metabolites, etc.

1.1 Carbohydrate metabolism

Glycolysis / Gluconeogenesis Enzymes

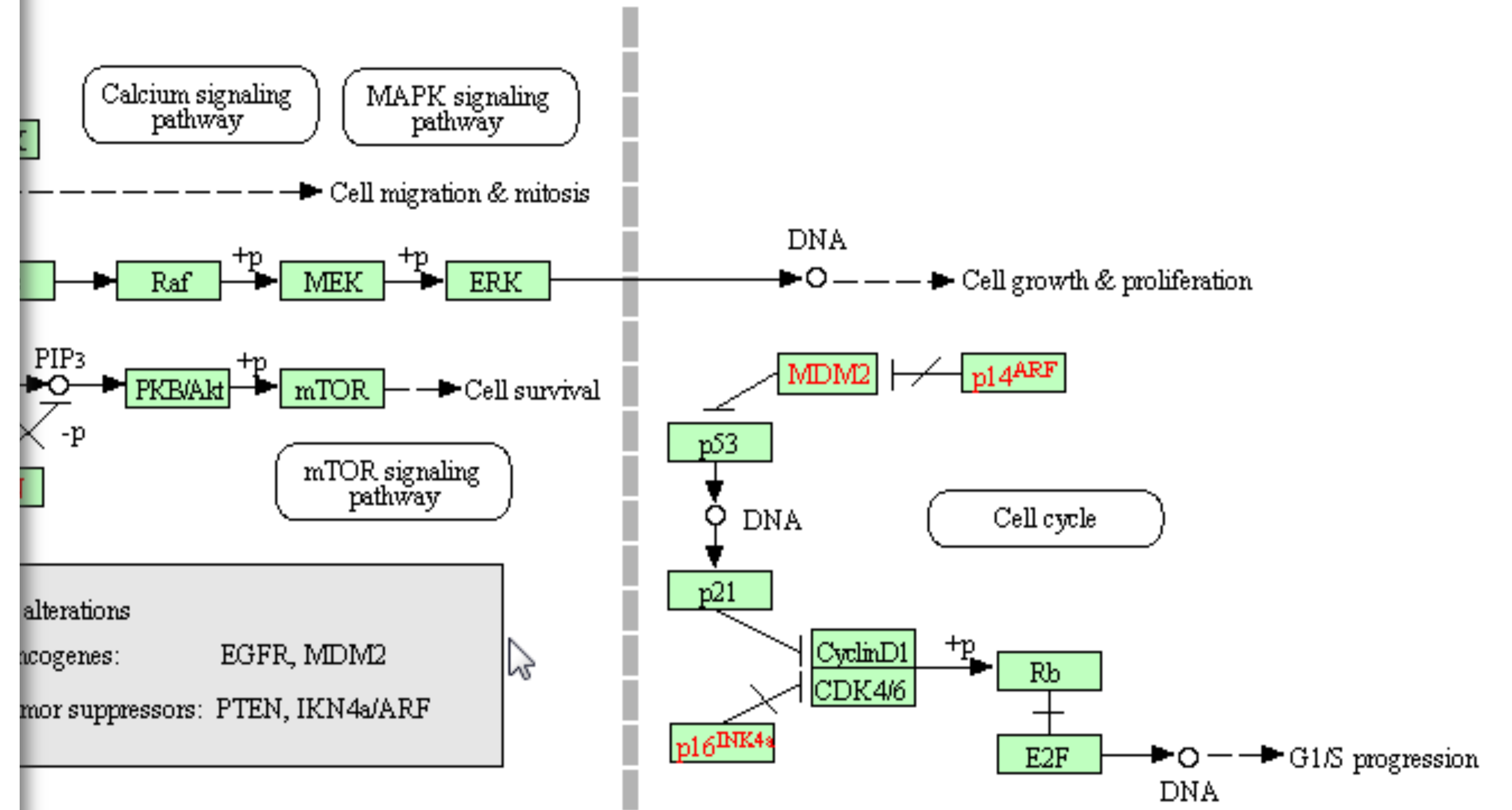

A Pathway

The bigger picture

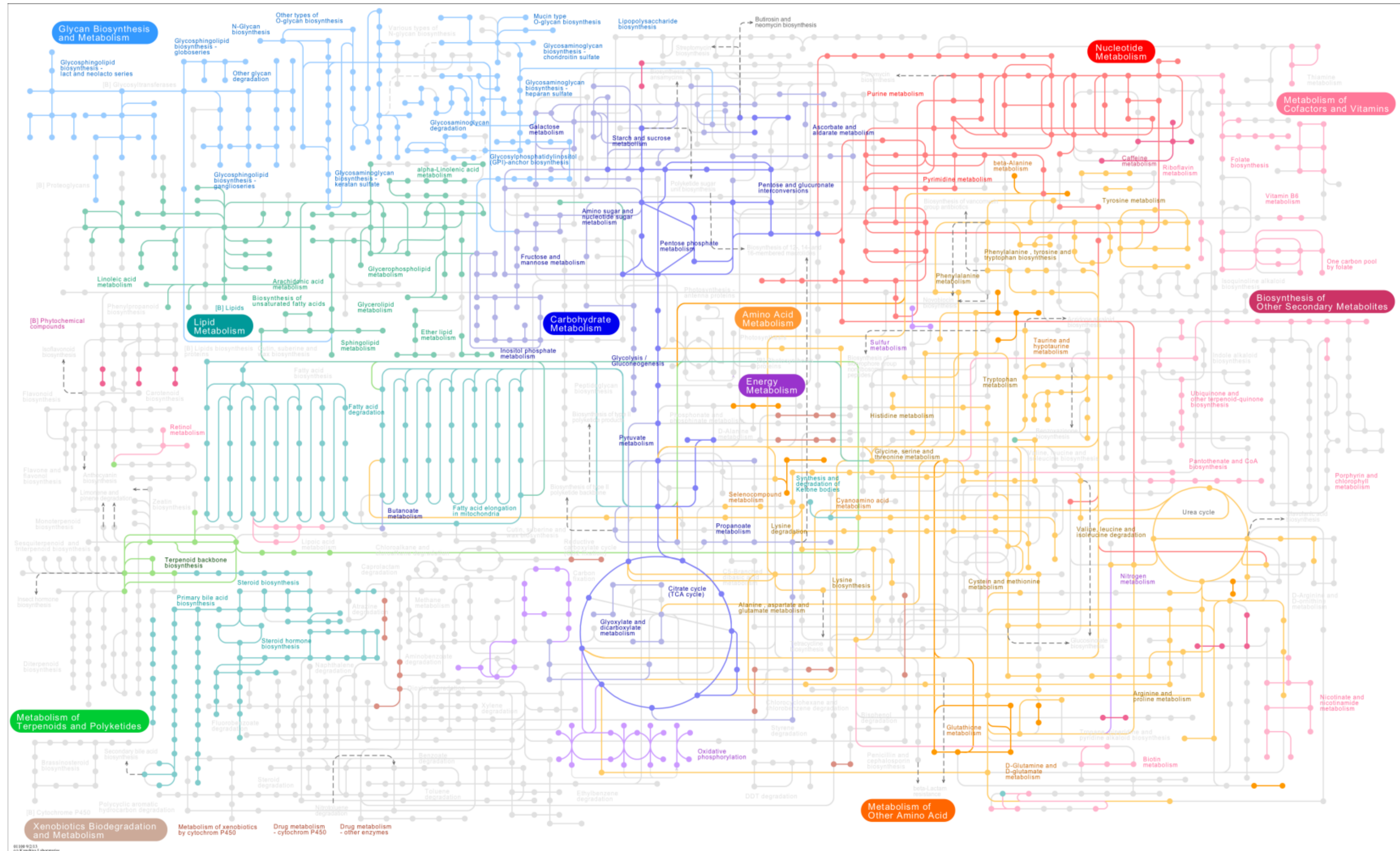

Background

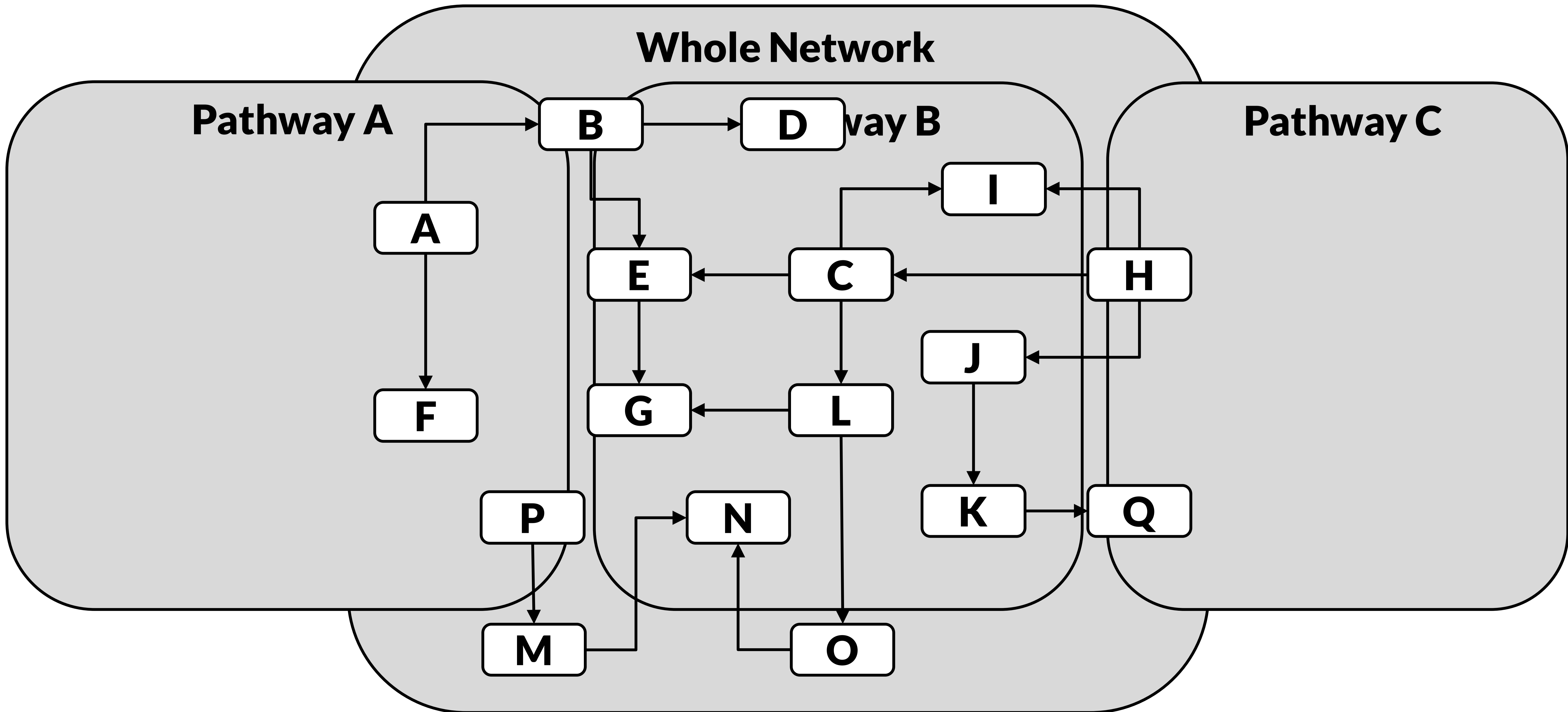

GLIOMA

A Pathway

De Novo pathway
Glial progenitor cell

Glial progenitor cell

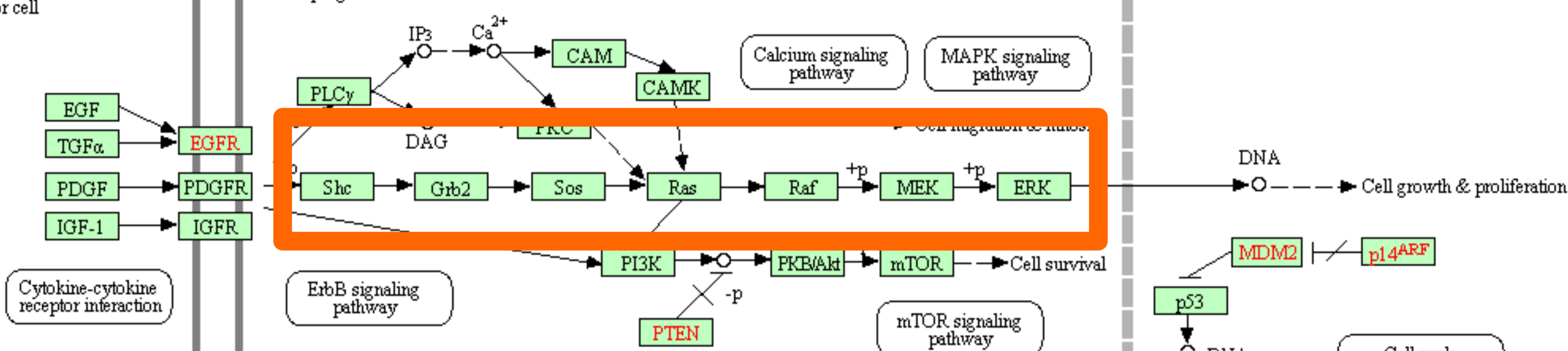

Primary GBM
(Glioblastoma multiforme)

ERBB SIGNALING PATHWAY

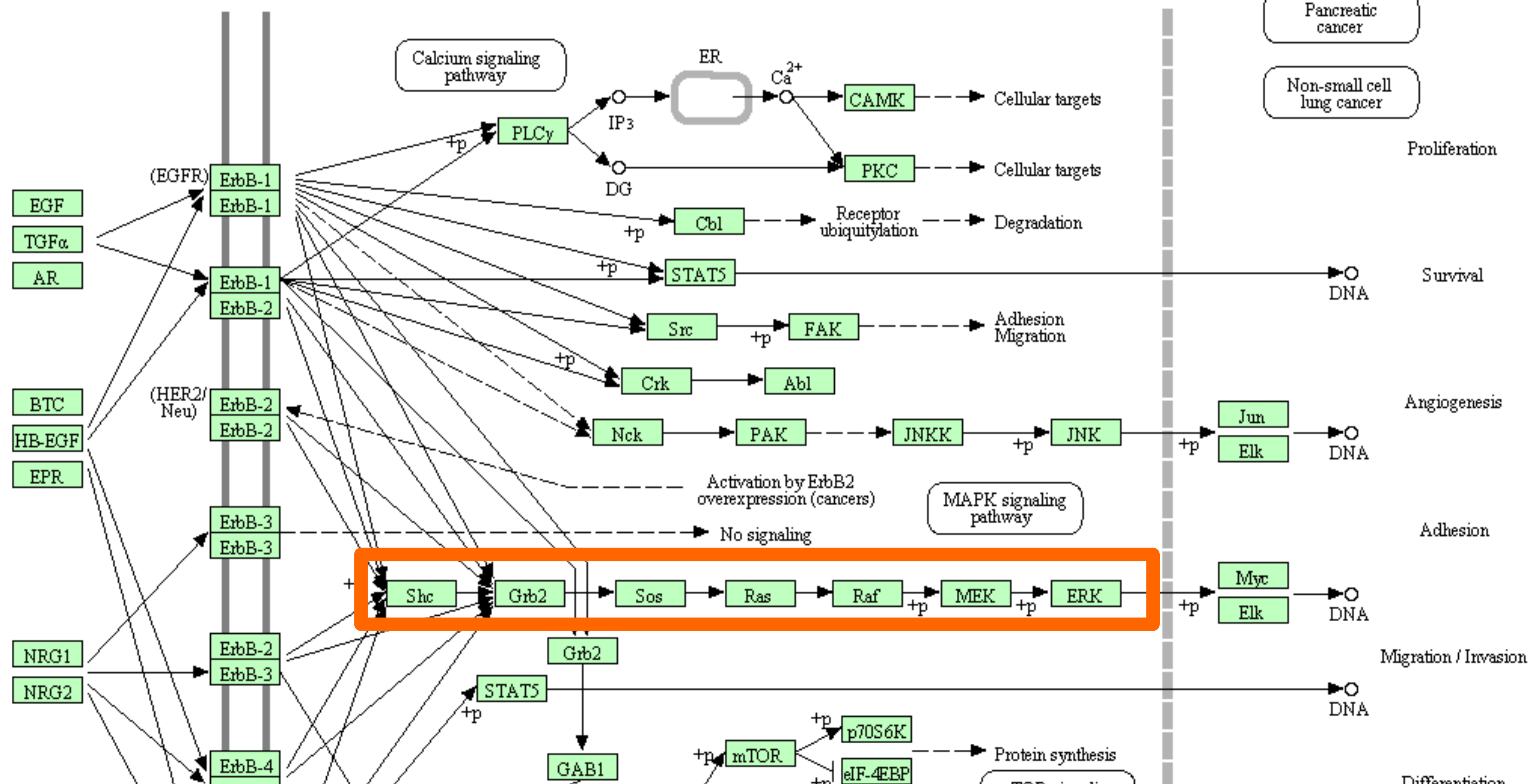

Two Problems - Two Solutions

- 1. Large Partitioned Network**
- 2. Many Node Attributes**

Large Partitioned Network

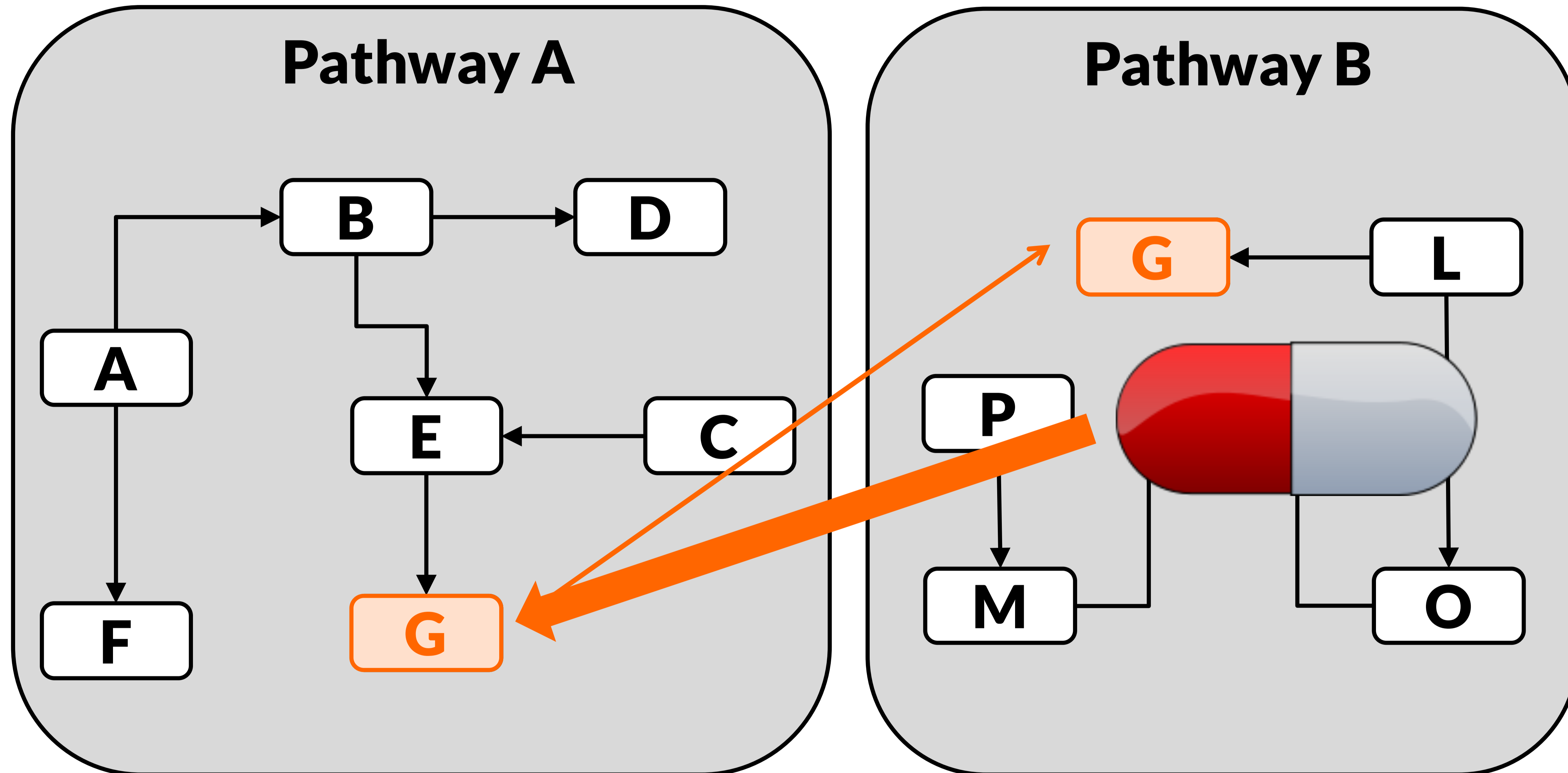

Drug side-effects

Drug repositioning

Many Node Attributes

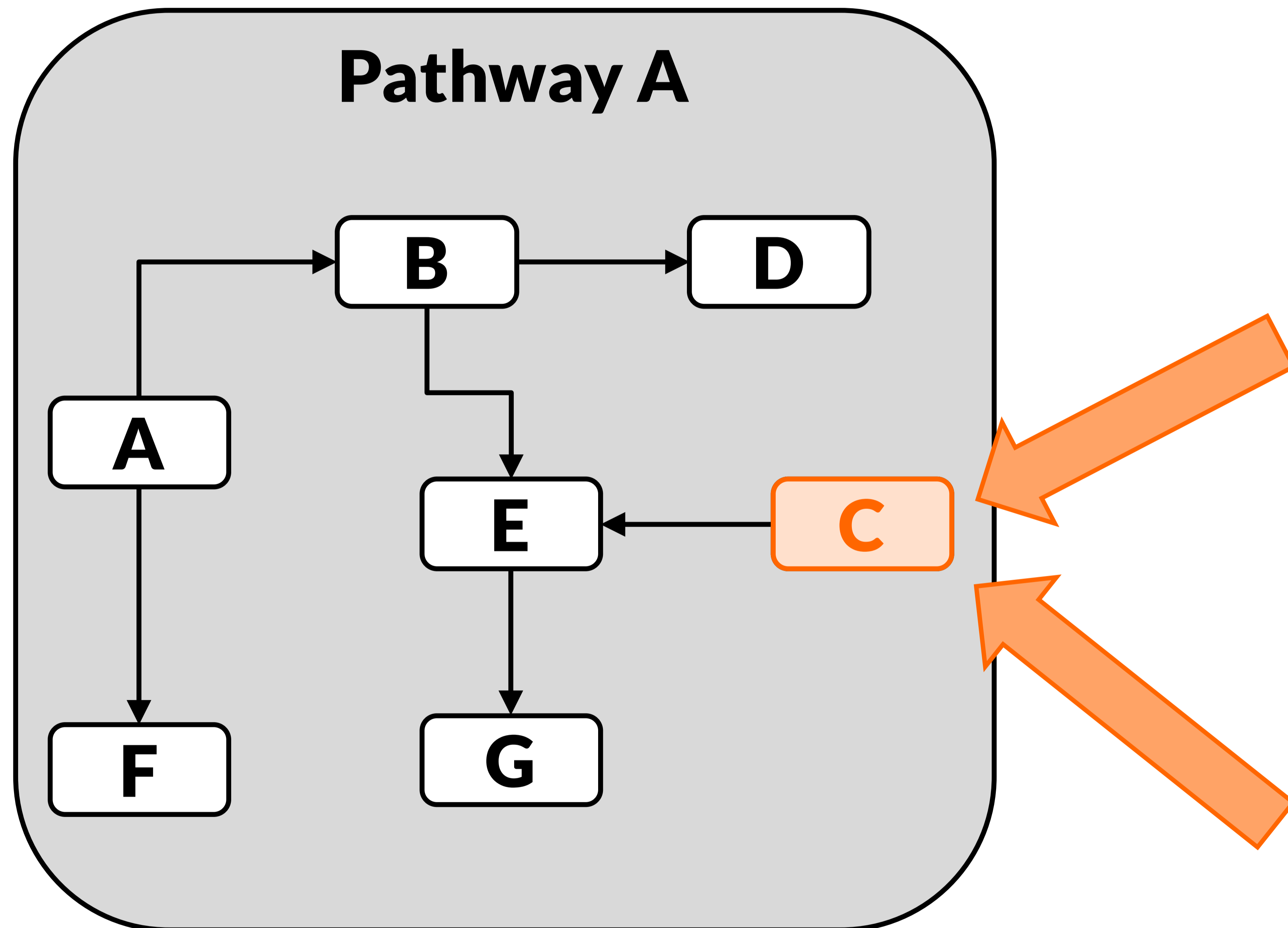

Node	Sample 1	Sample 2	Sample 3	...
A	0.55	0.95	0.83	...
B	0.12	0.42	0.16	...
C	0.33	0.65	0.38	...
...

Node	Sample 1	Sample 2	Sample 3	...
A	low	low	very high	...
B	normal	low	high	...
C	high	very low	normal	...
...

How to visualize experimental data on pathways?

Visualizing Large Partitioned Networks

Approaches

Whole Network

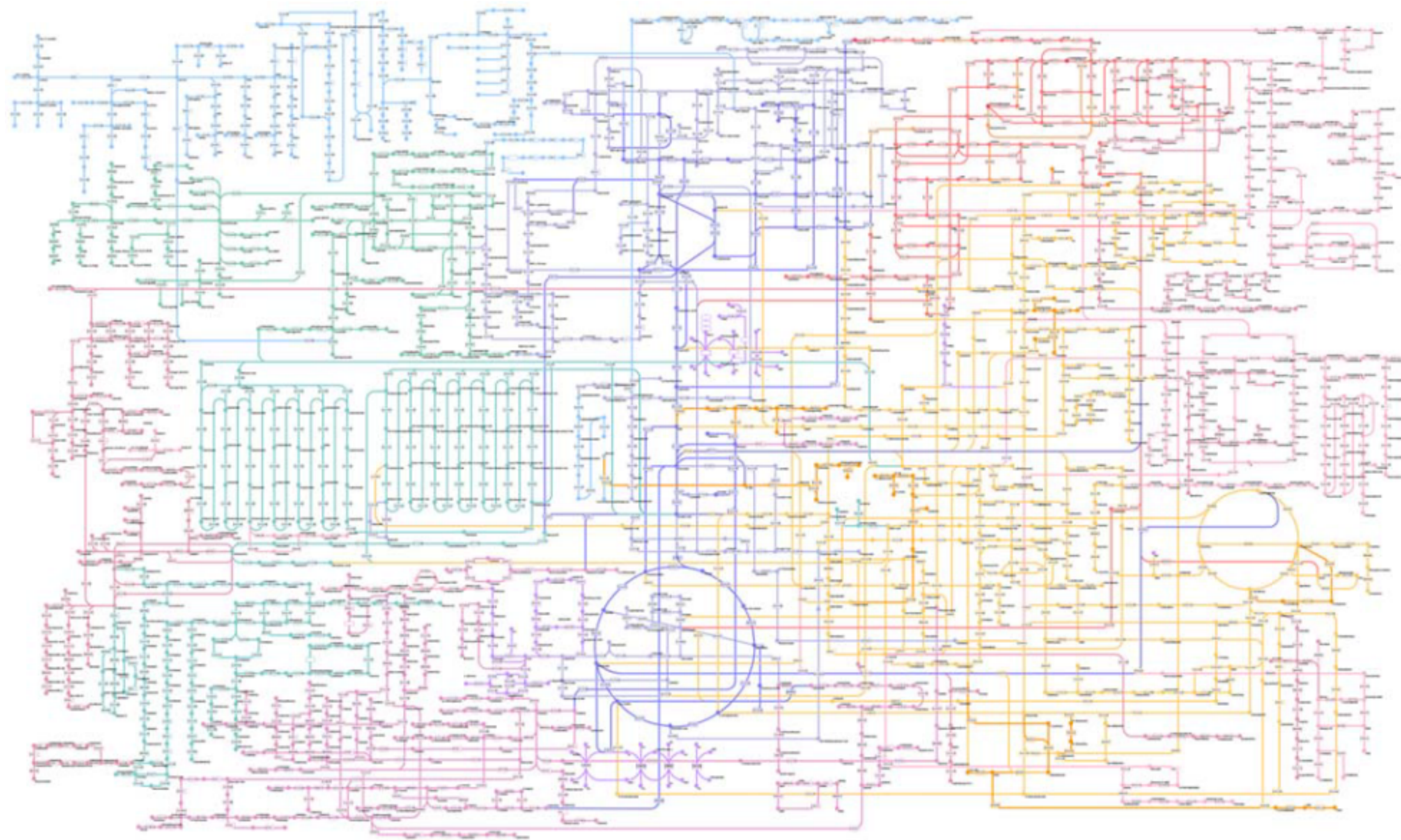

[Kono2009]

Connected Pathways

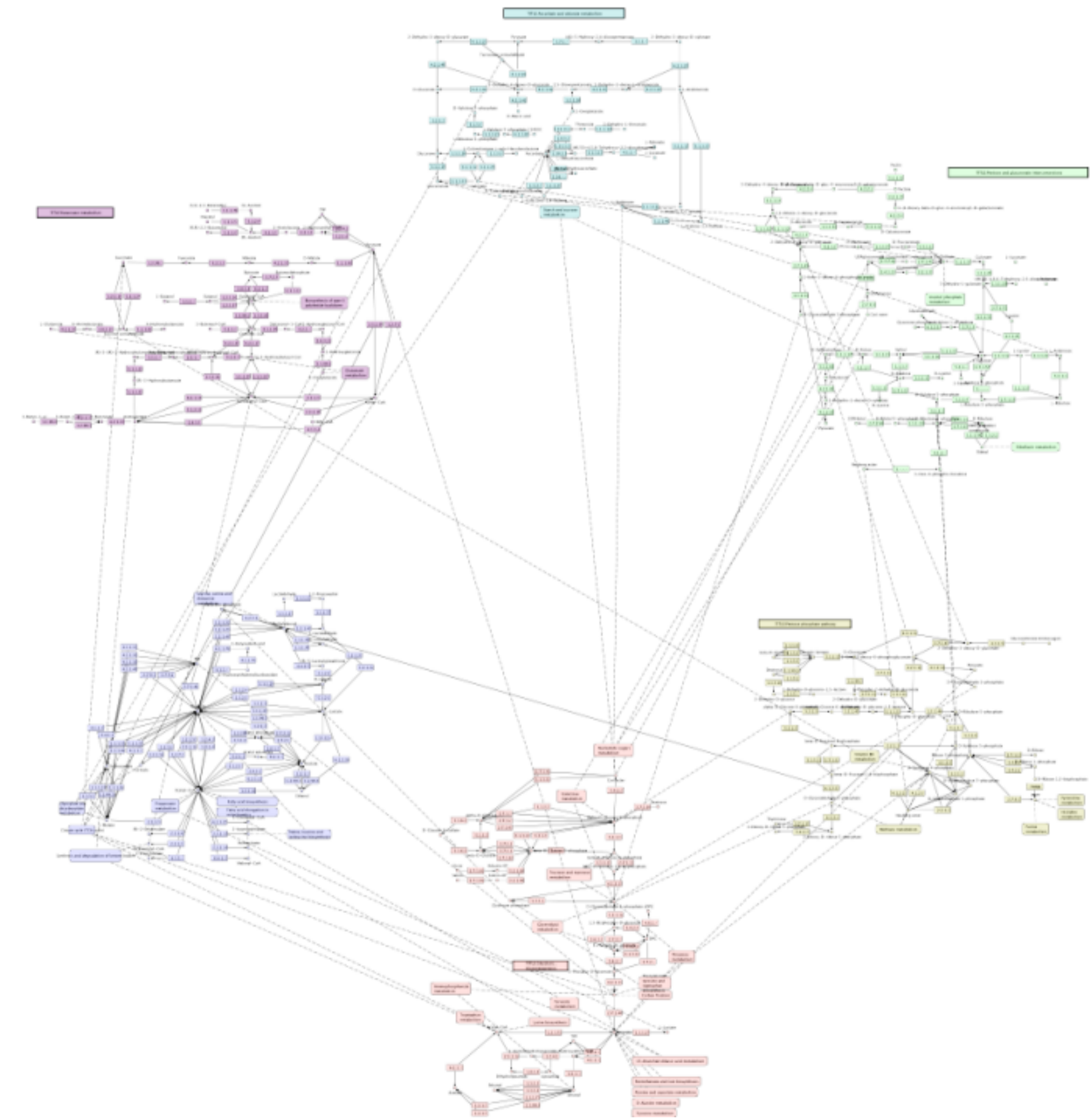

[Klukas2006]

Step 1: Finding Related Pathways

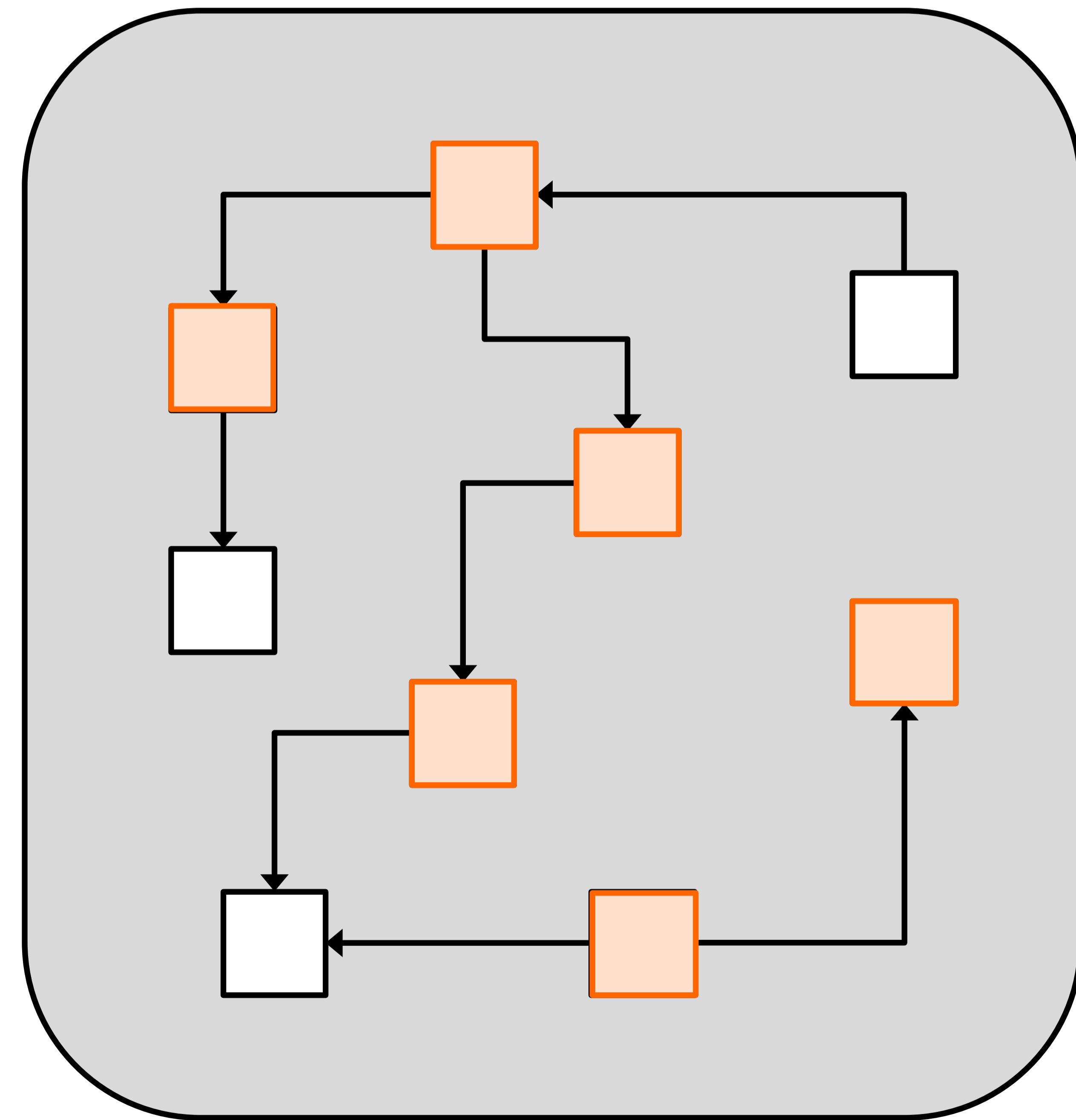
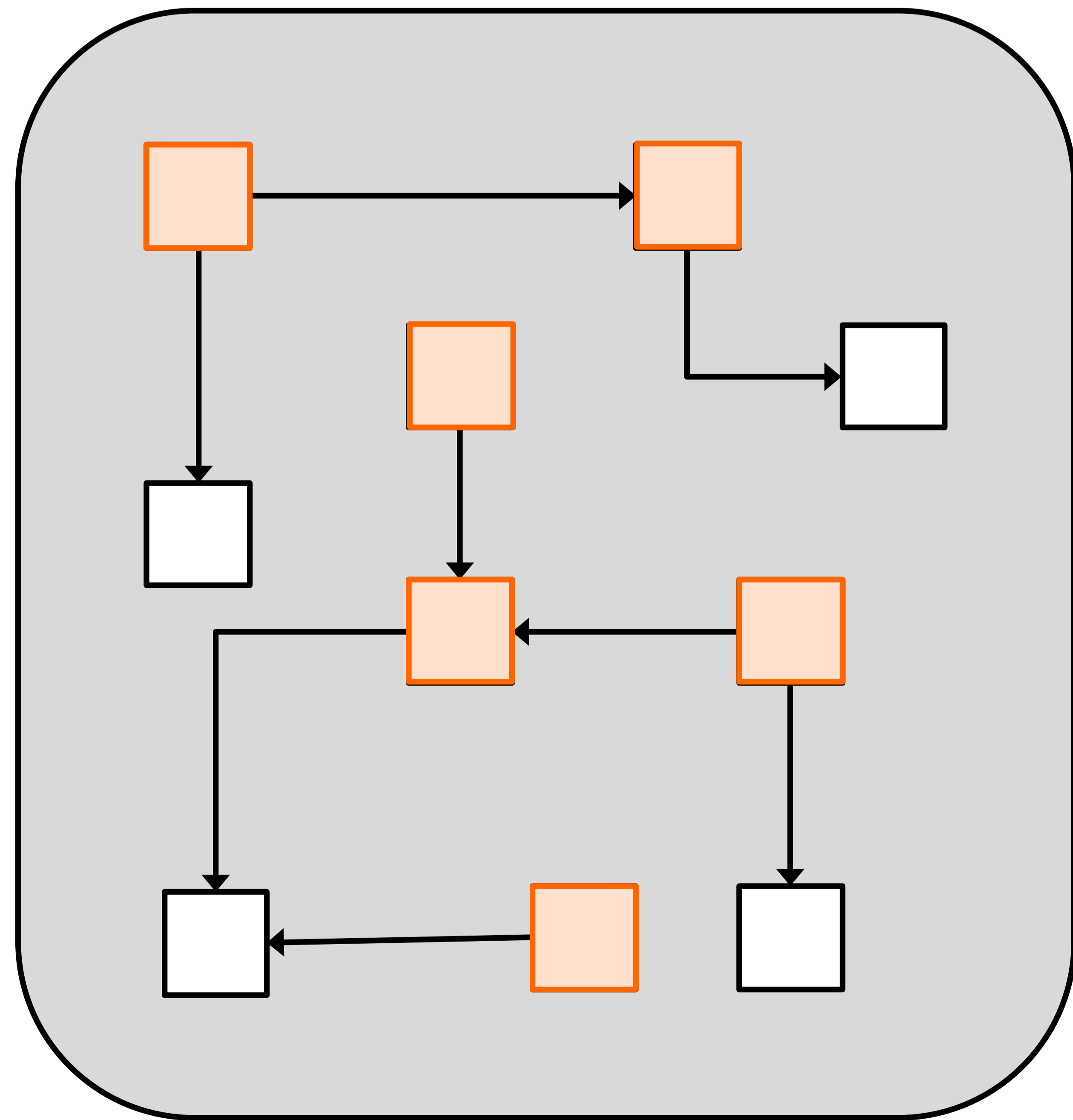

Finding Related Pathways

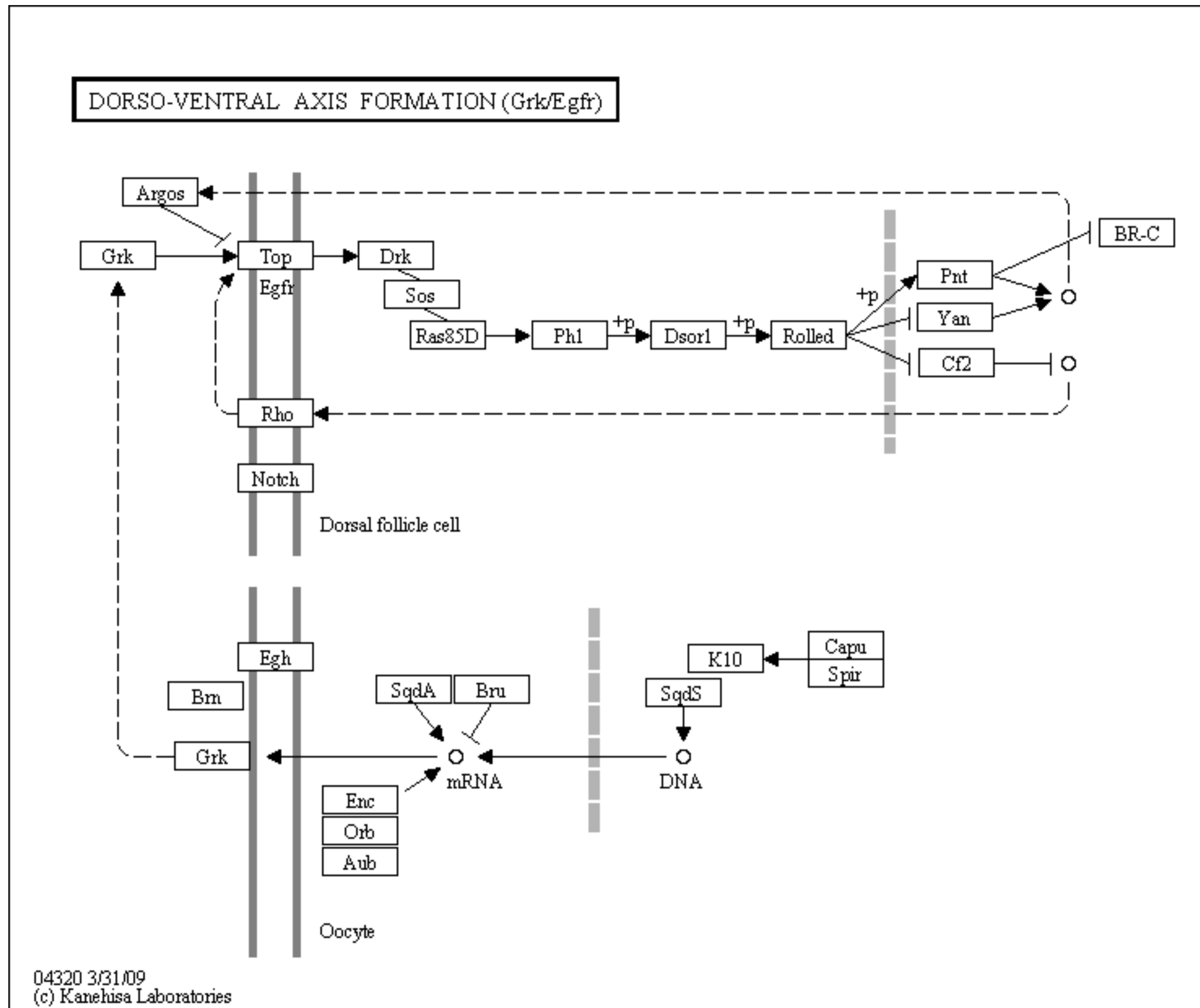

Pathway	Commo
Nifedipine Activity	
Endometrial cancer	
Thyroid cancer	
Melanoma	
Acute myeloid leukem	
Signaling of Hepatocy	
Non-small cell lung c	
Renal cell carcinoma	
Bladder cancer	
Gap junction	
GnRH signaling path	
Glioma	
IL-9 signaling pathwa	
Progesterone-mediate	
Estrogen signaling pa	
EPO Receptor Signali	
Prostate cancer	
IL-5 signaling pathwa	
Chronic myeloid leuk	
ErbB signaling pathw	
Fc epsilon RI signali	
Osteopontin Signaling	
Serotonin Receptor 2	
ErbB signaling pathw	
IL-3 Signaling Pathwa	
B cell receptor signal	
Prion diseases	
Prolactin signaling pa	
Focal adhesion	

Step 2: Managing Display Space

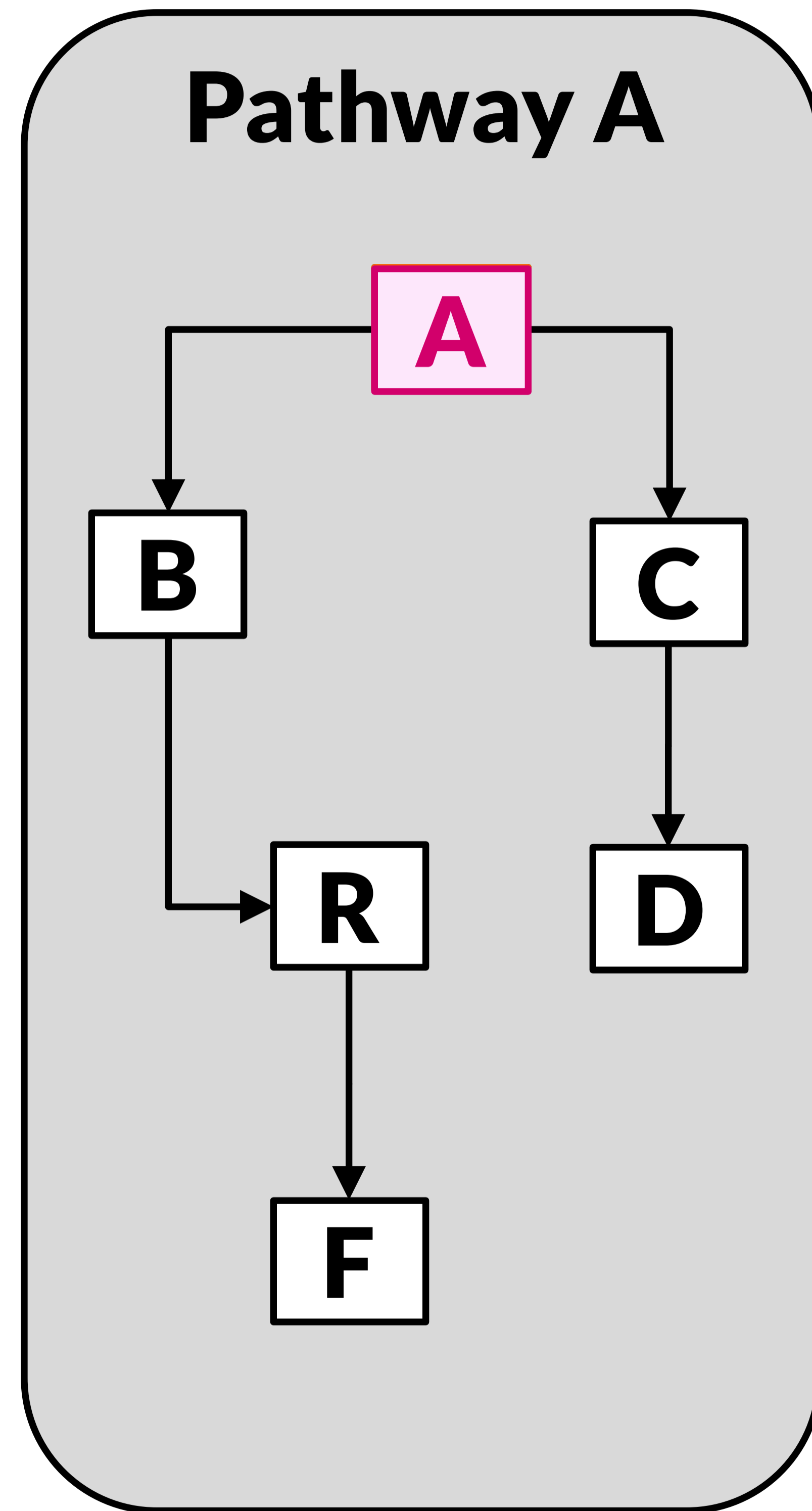

Focus Pathway

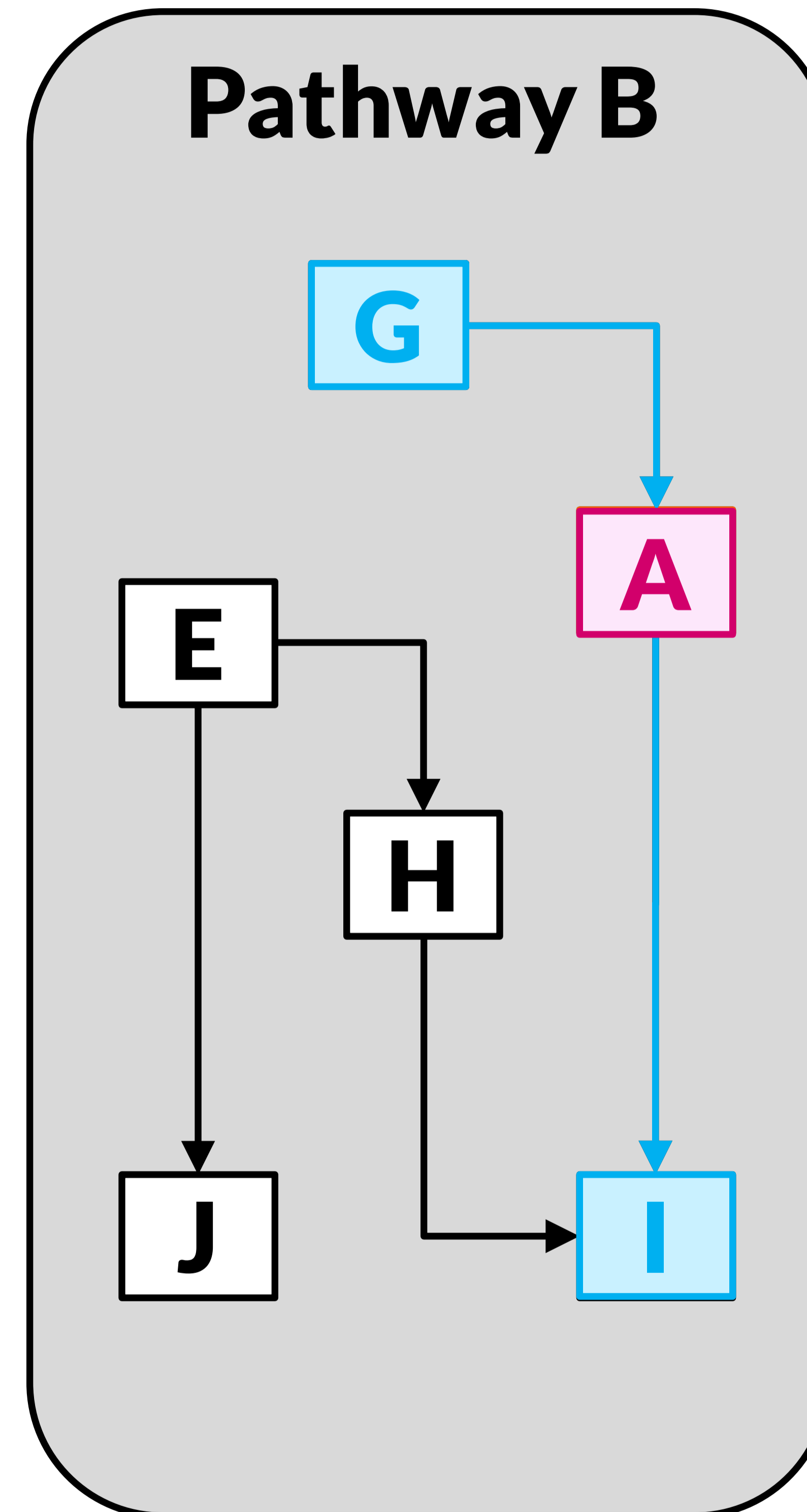

Context Pathway

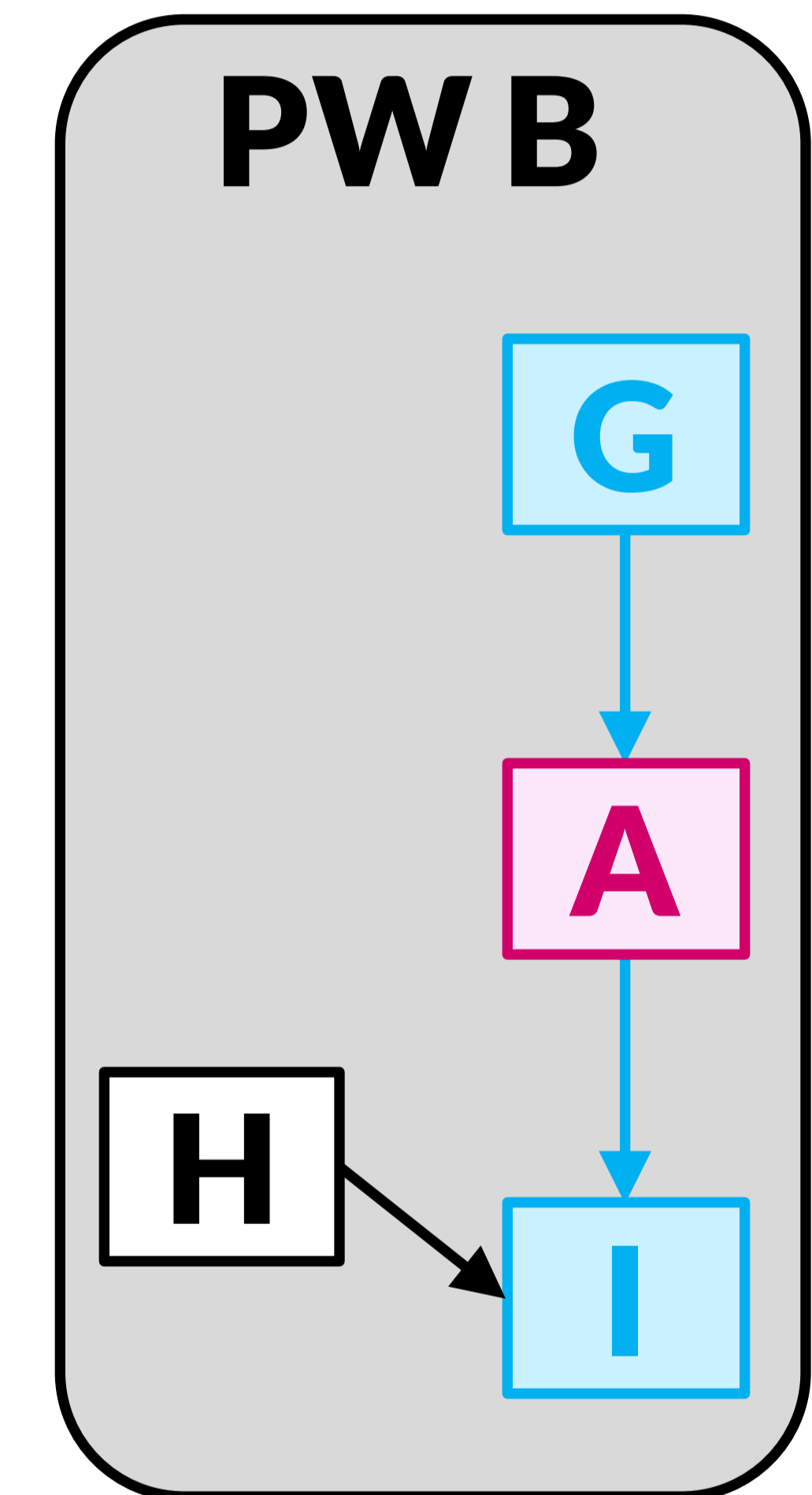
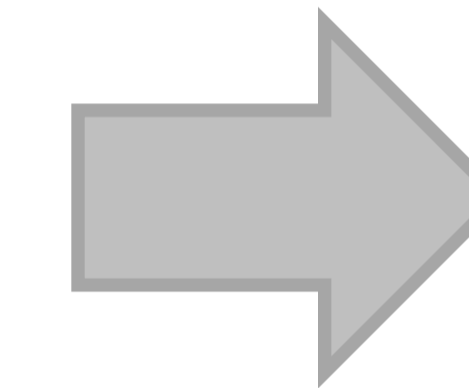

Contextual Subset

Step 2: Managing Display Space

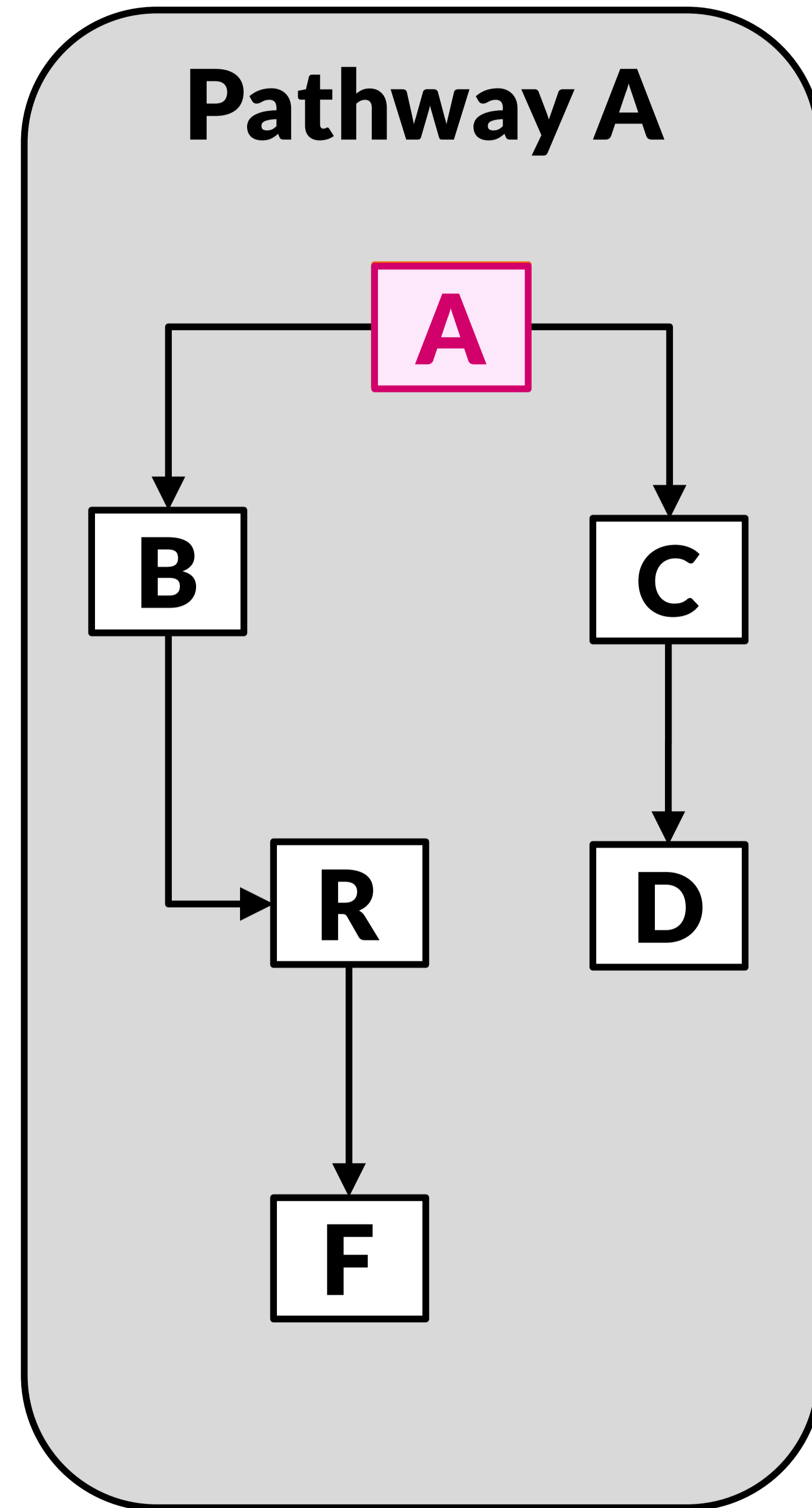

Focus Pathway

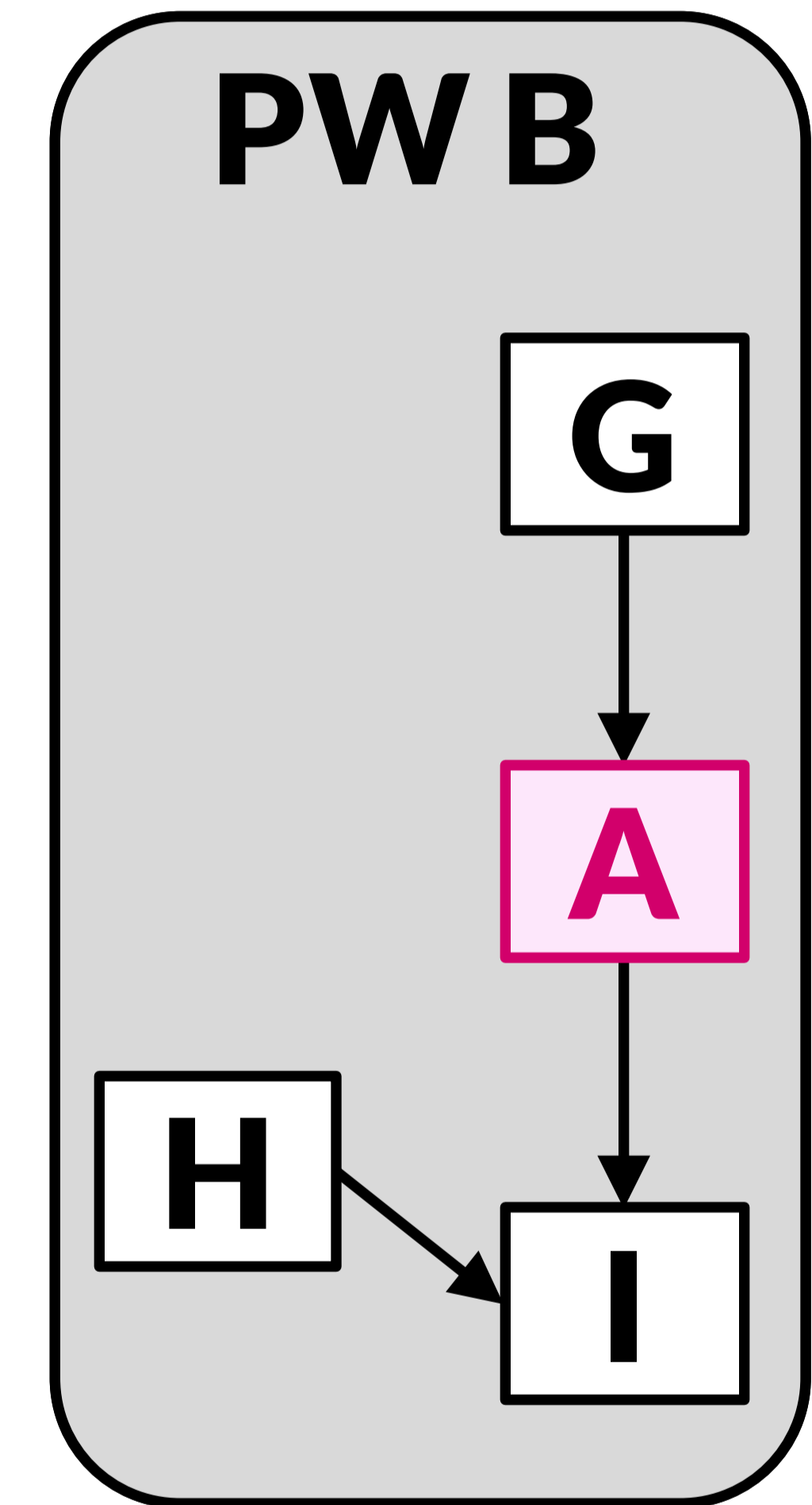
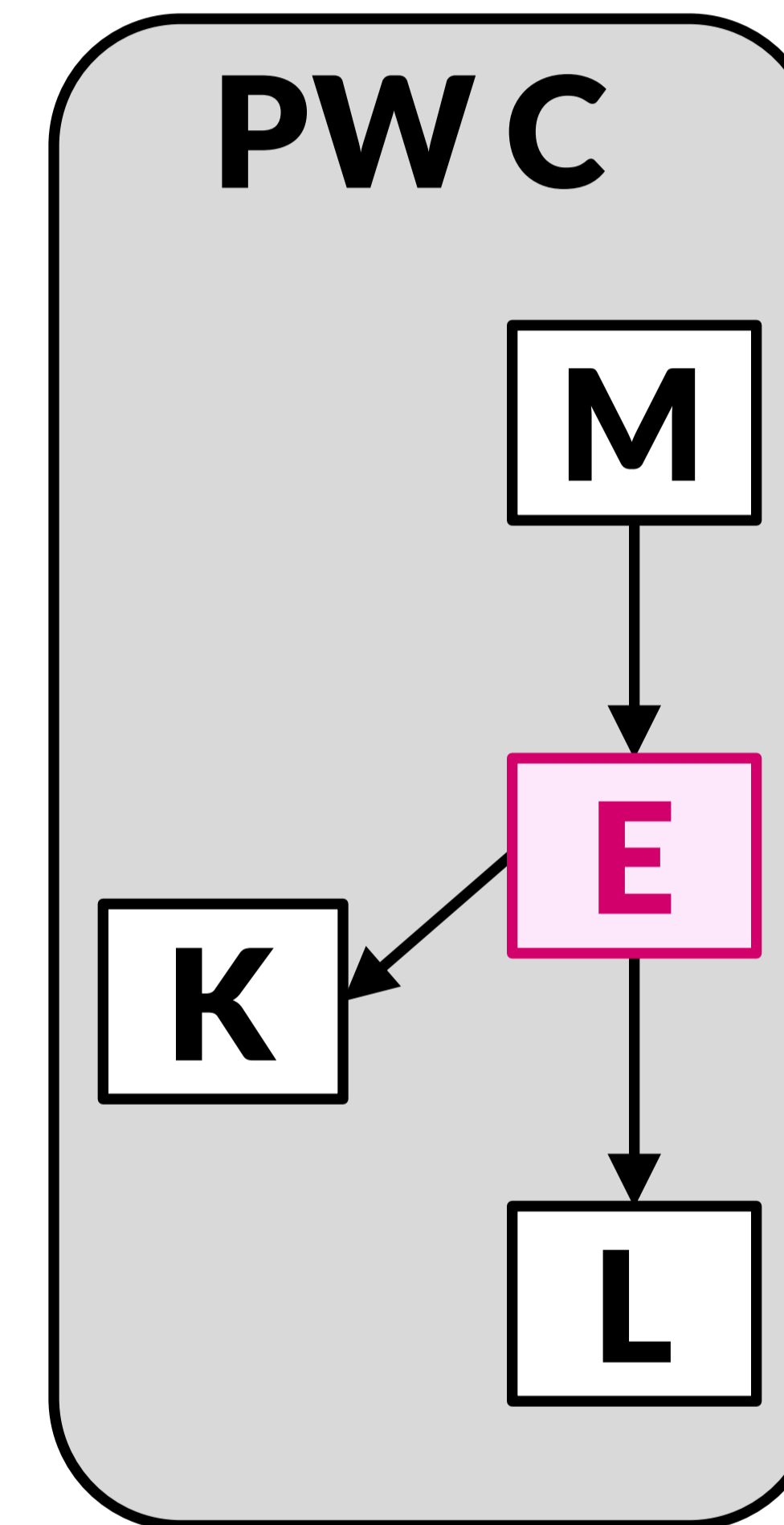

Context Pathways

Levels of Detail

Glioma

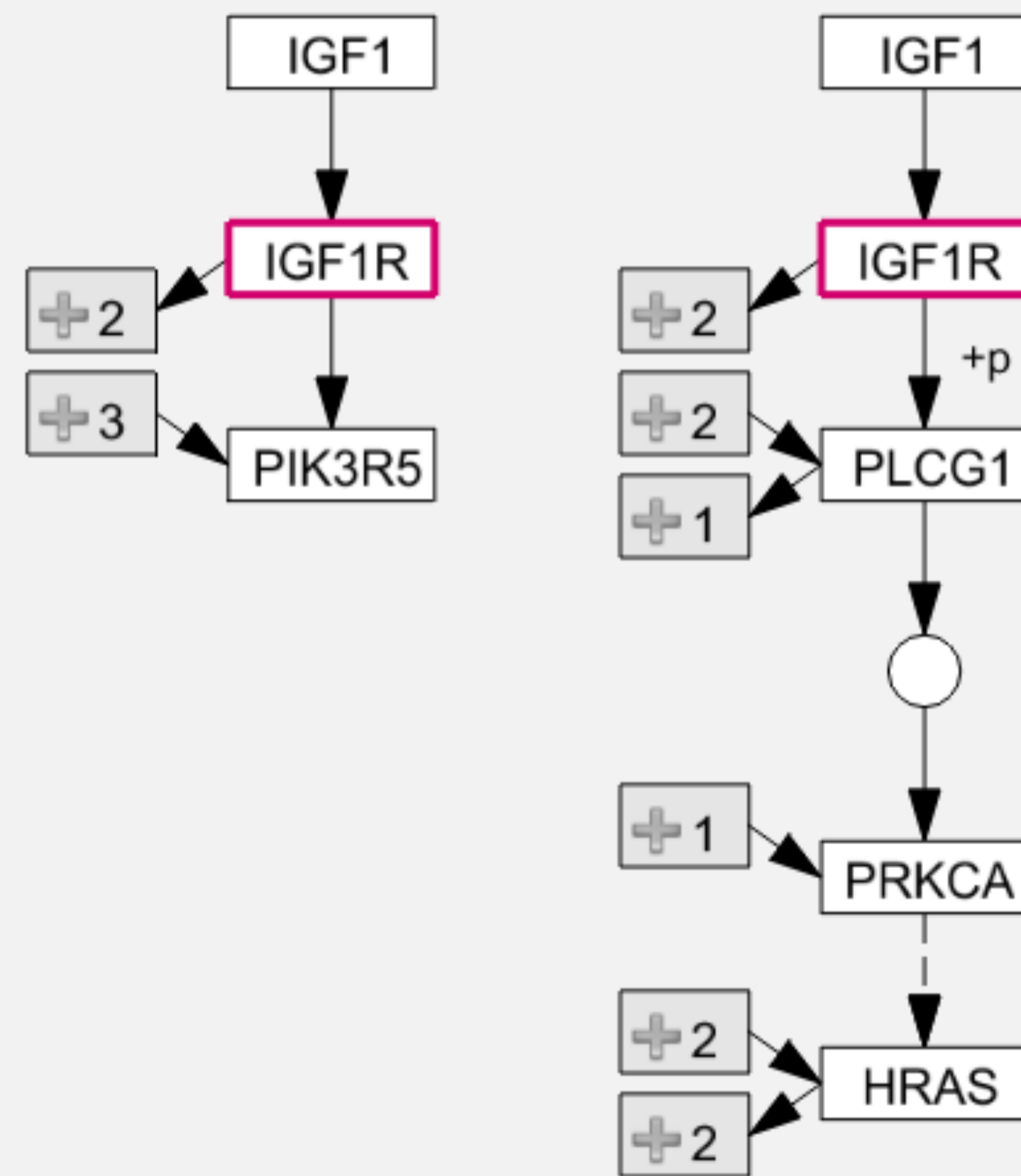
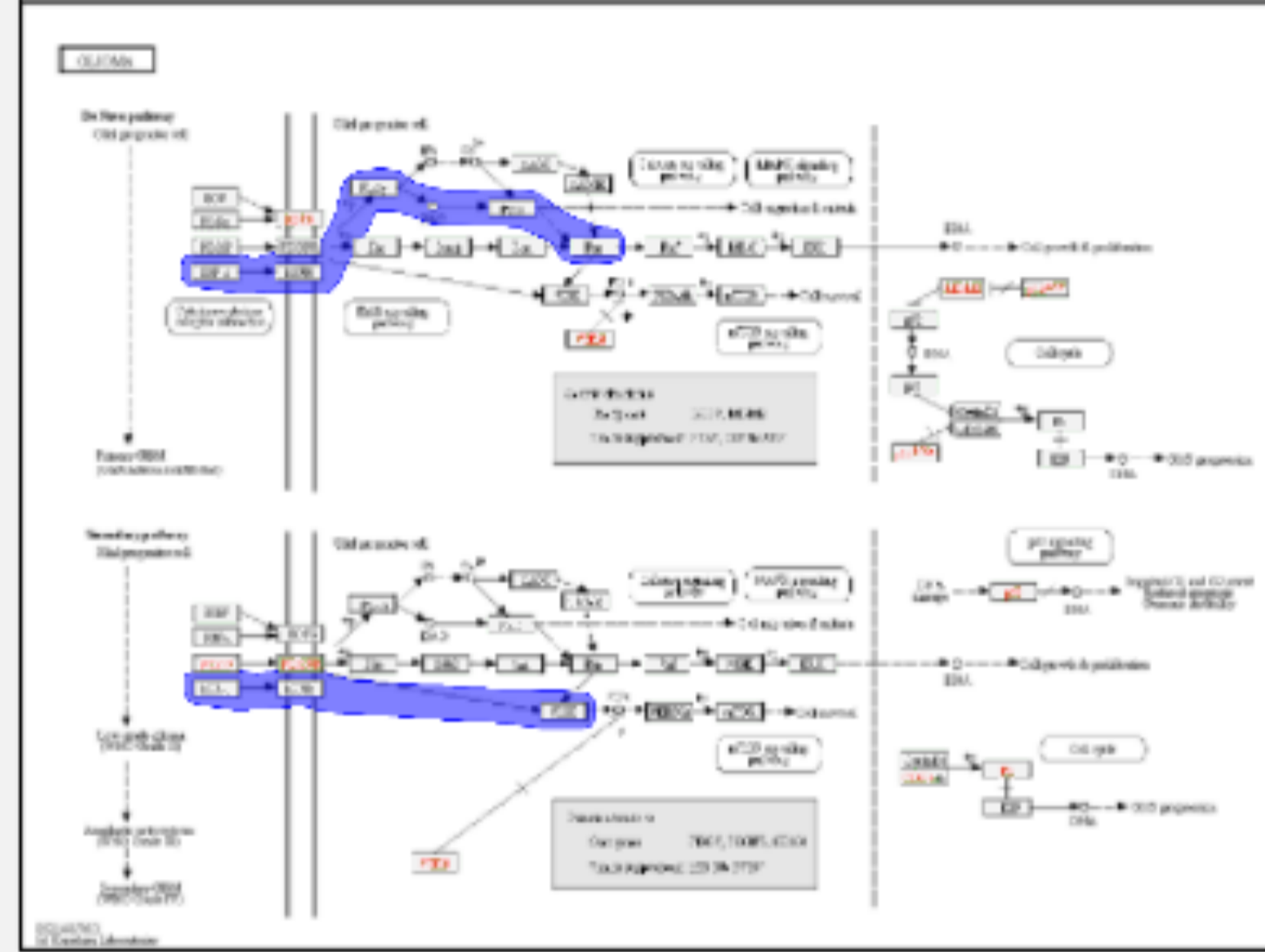

High

Glioma

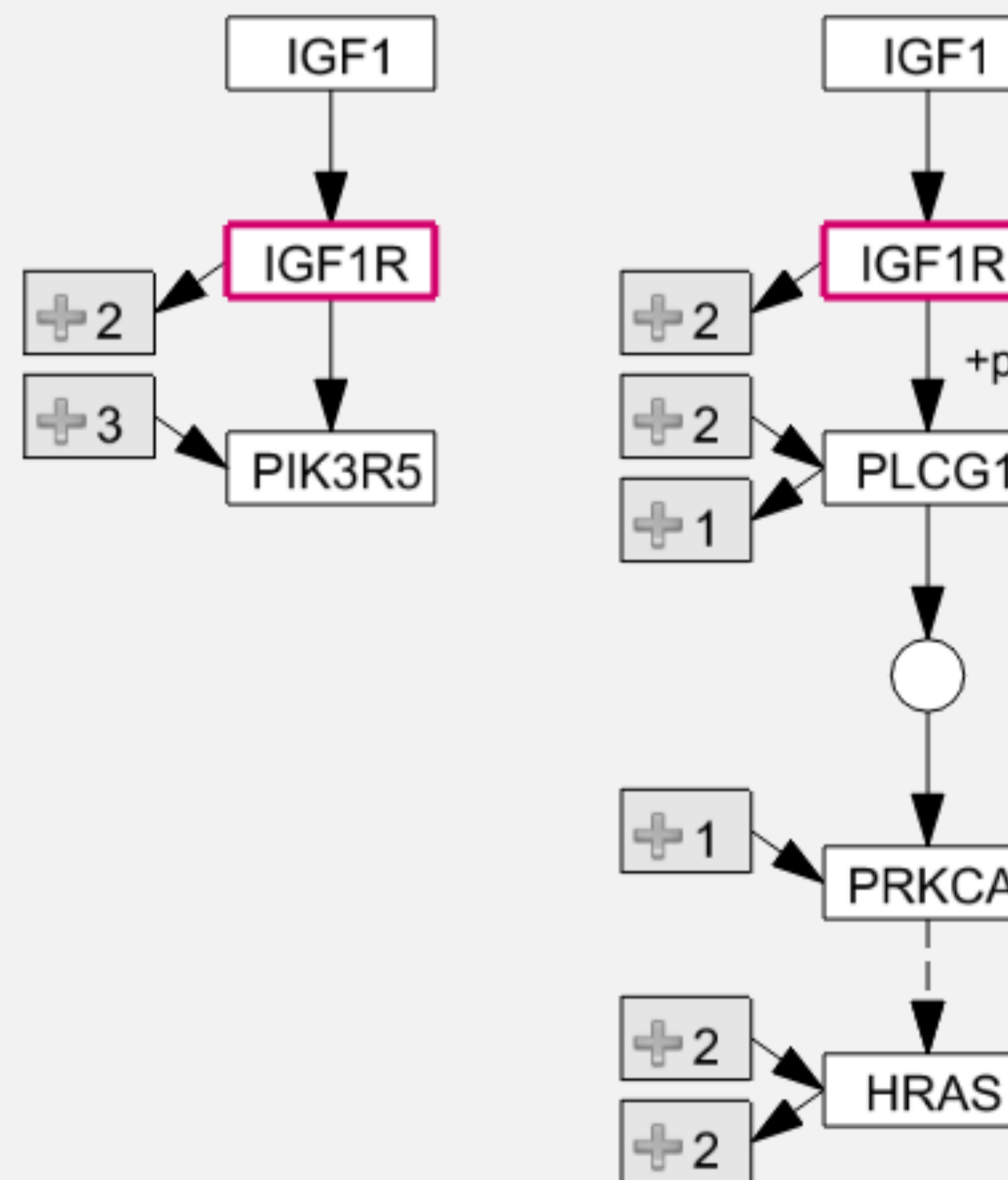

Medium

Glioma

Low

Layout

Glioma

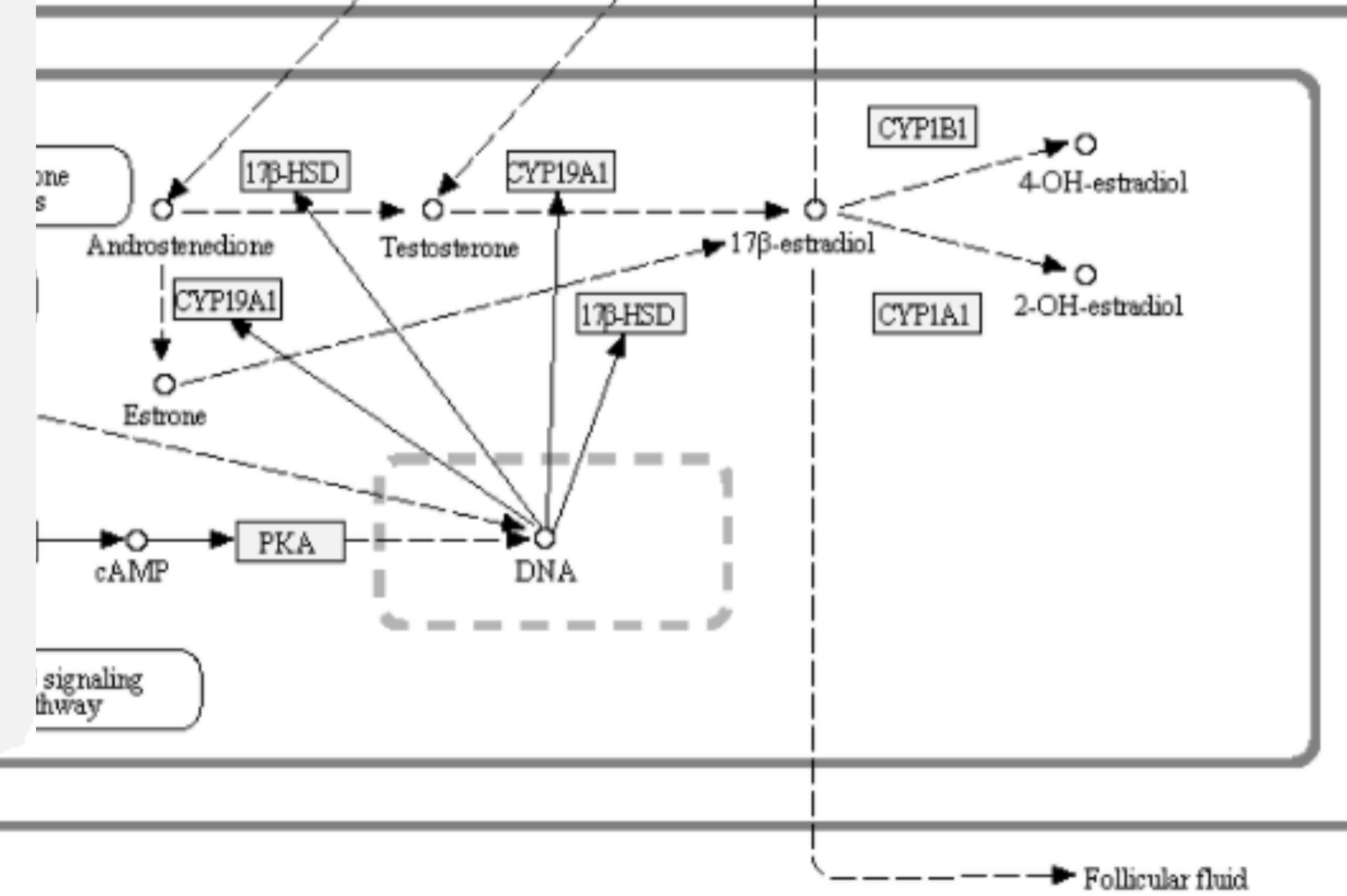
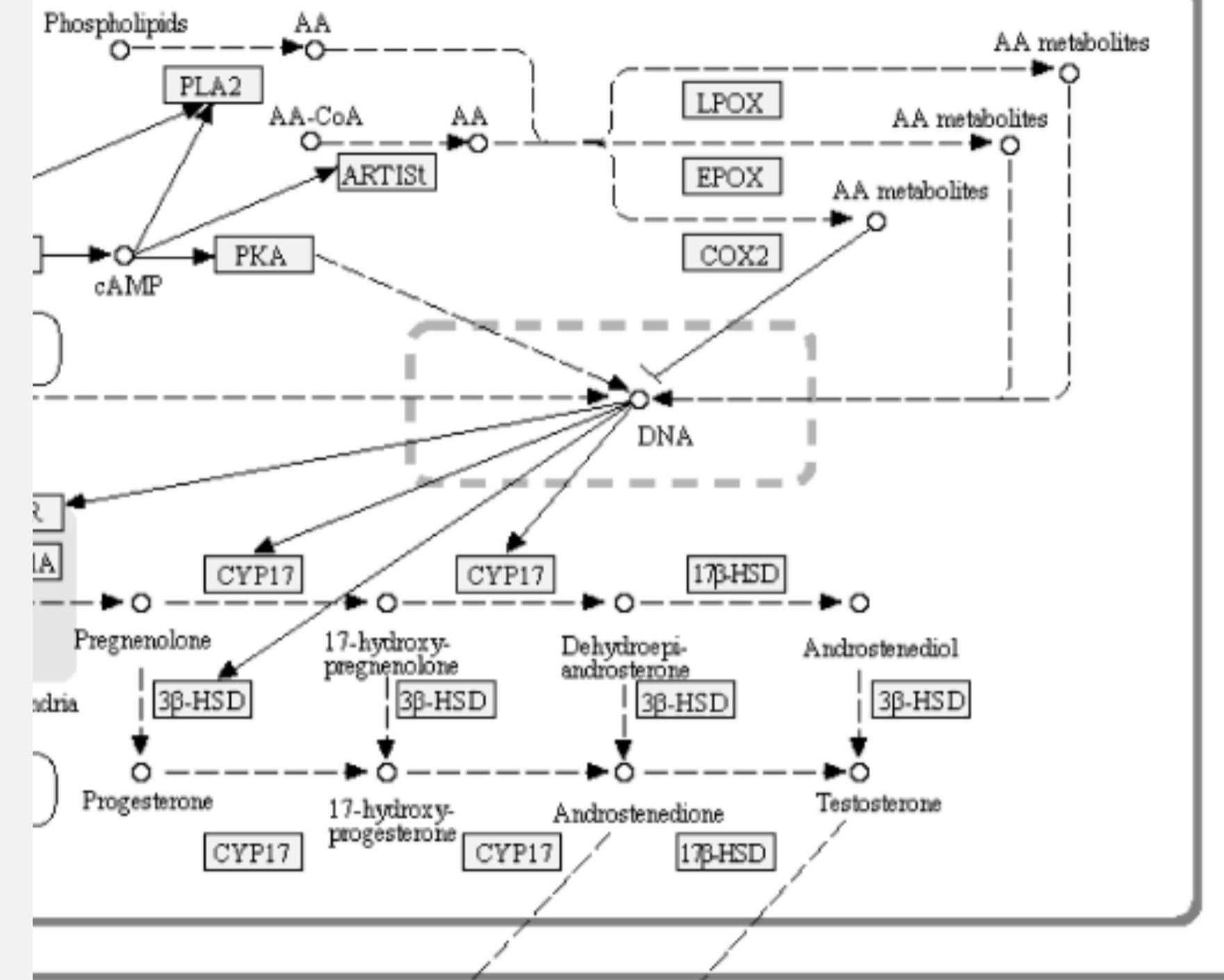
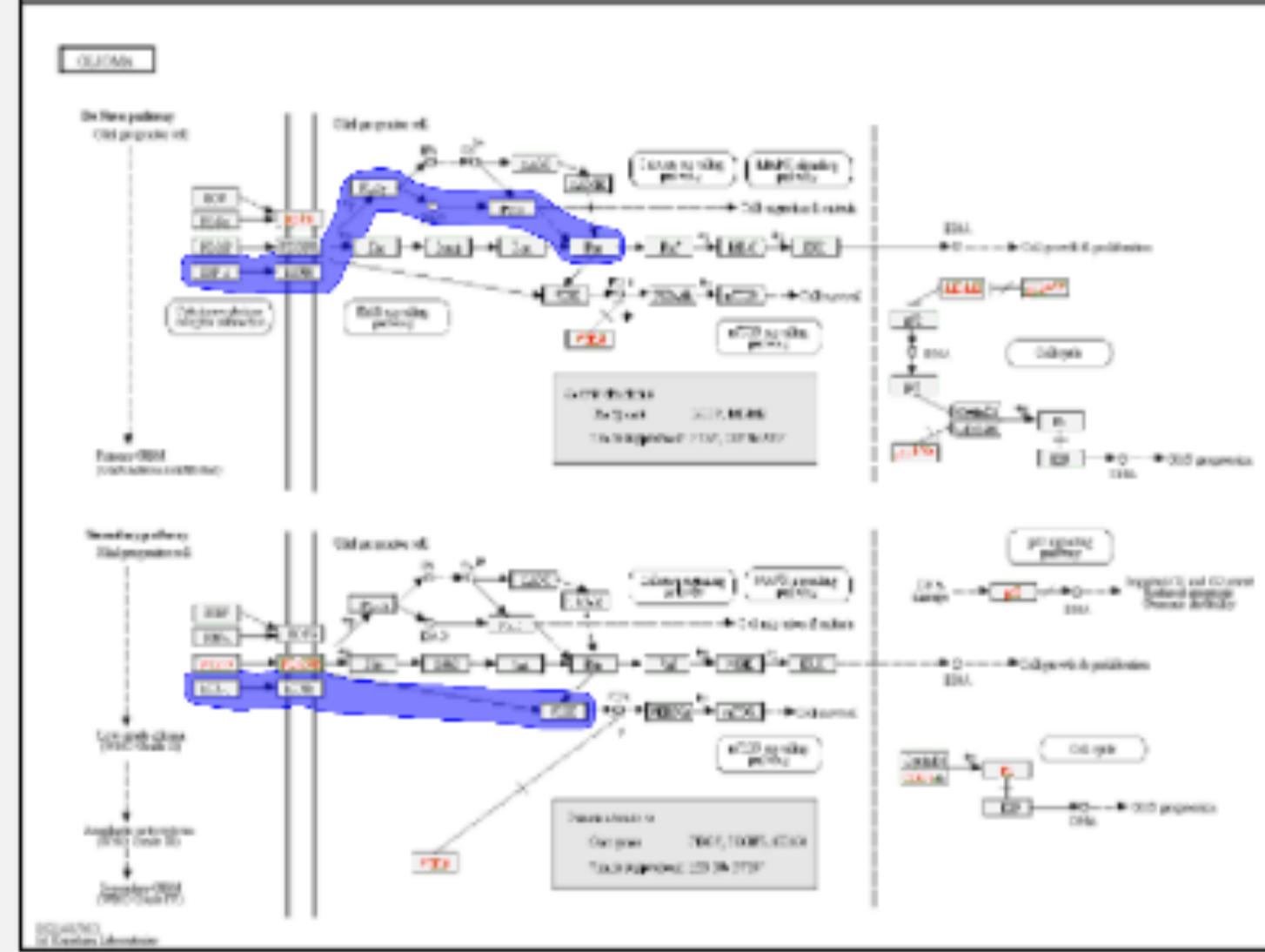

Prostate cancer

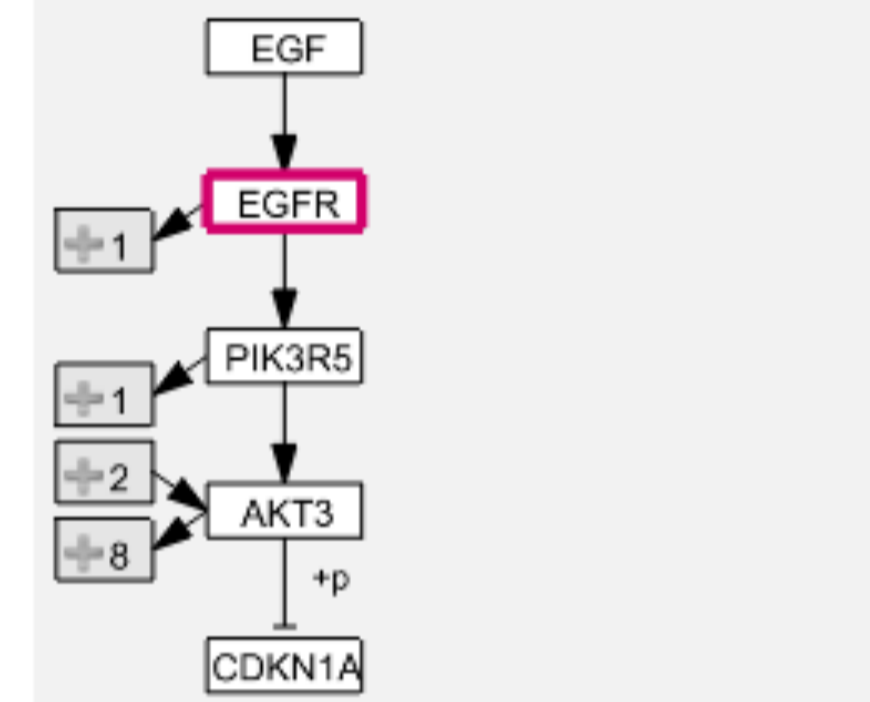
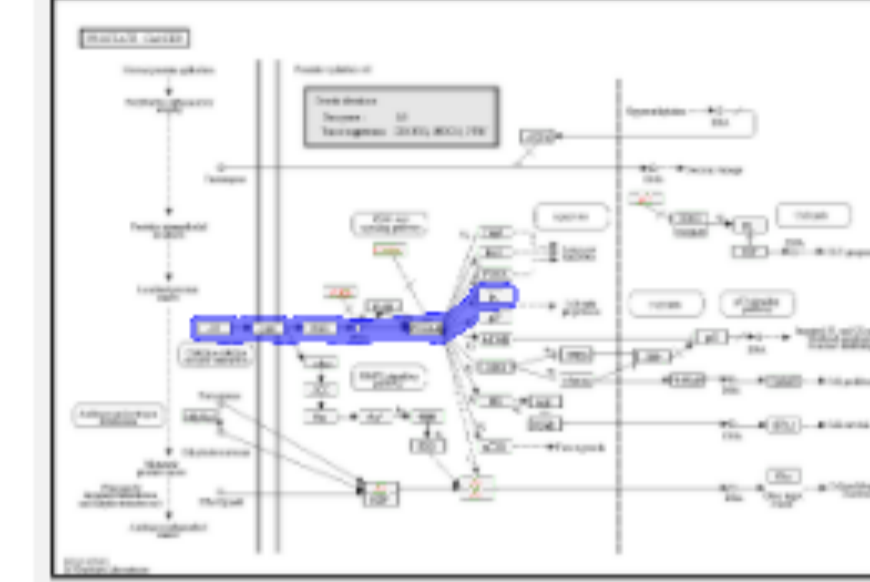

Proteoglycans in cancer

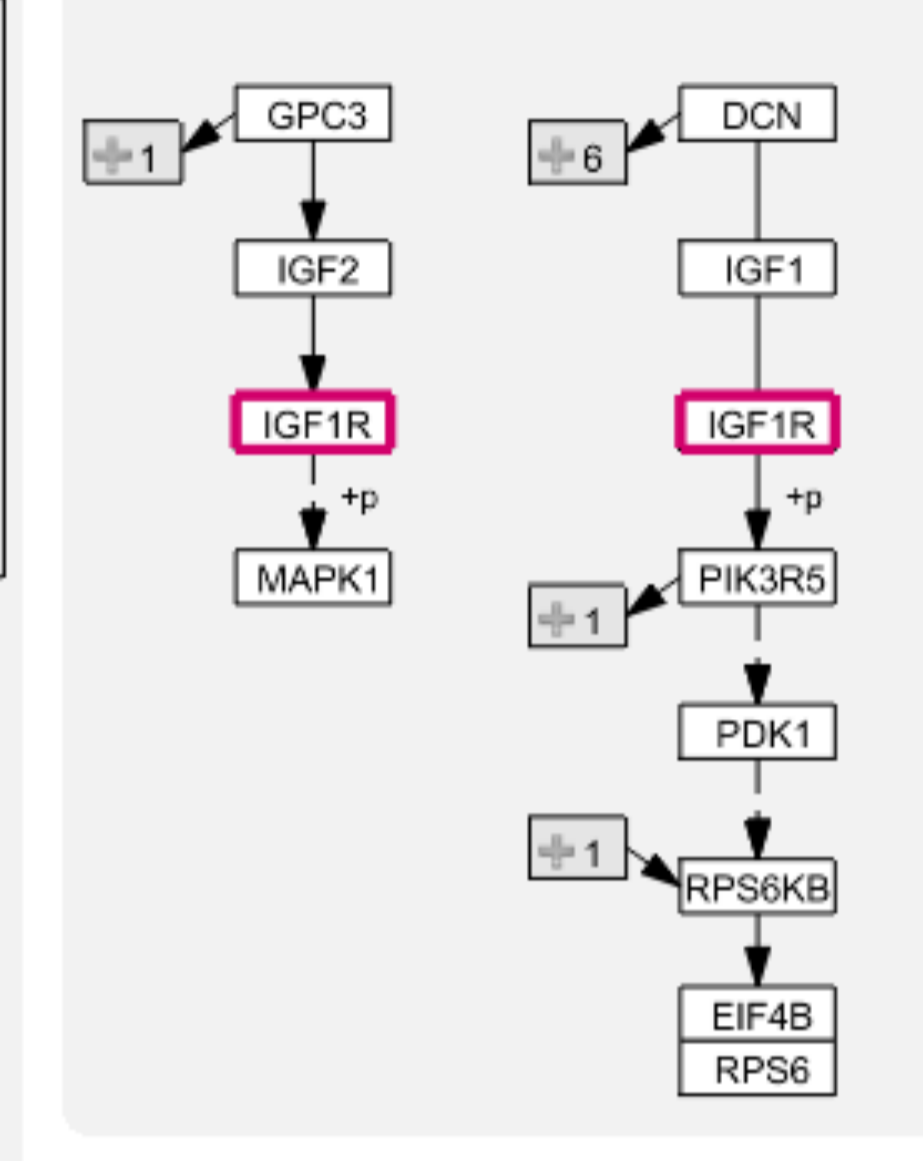

PI3K-Akt signaling pathway

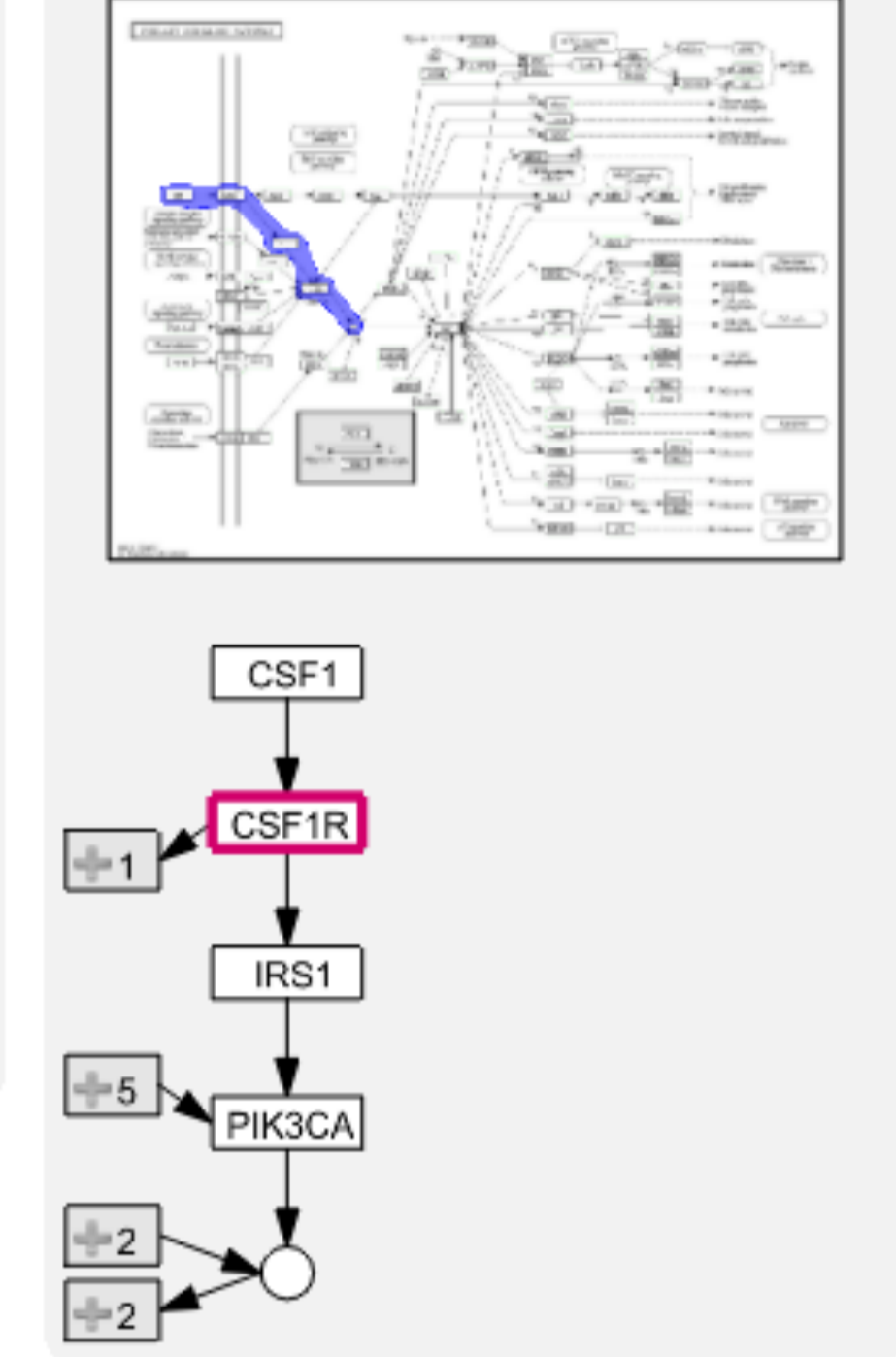

HIF-1 signaling pathway

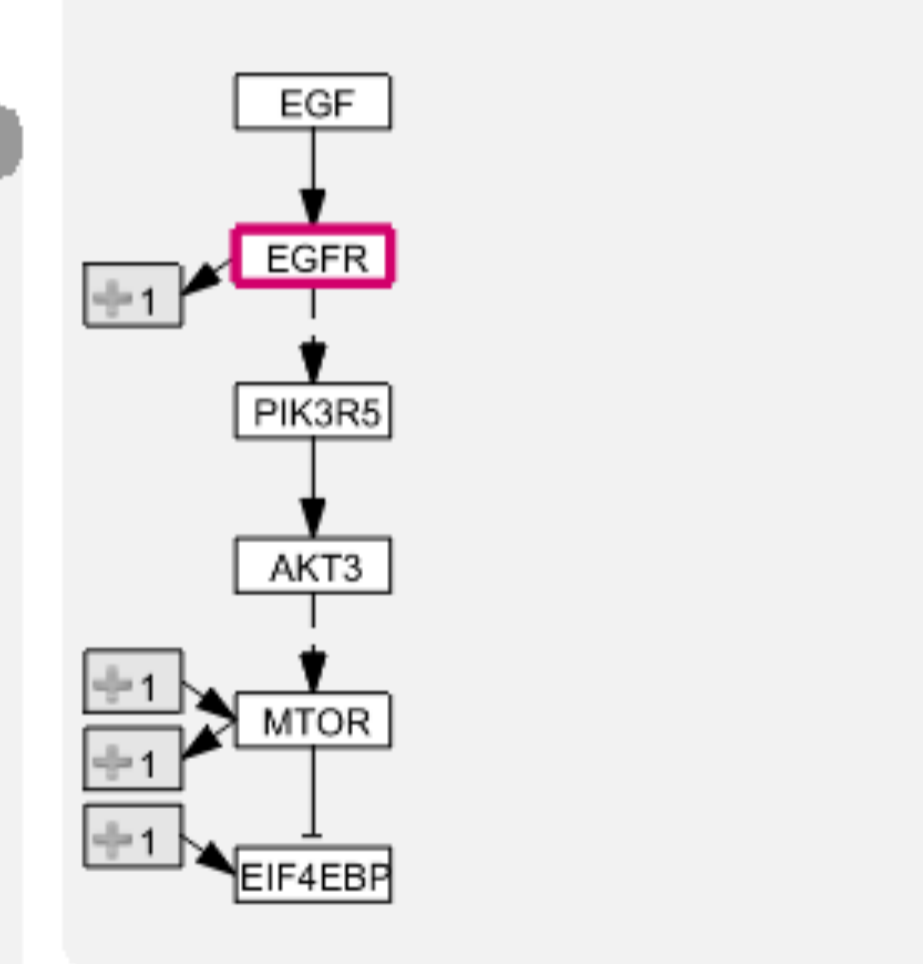

Progesterone-mediated oocyte

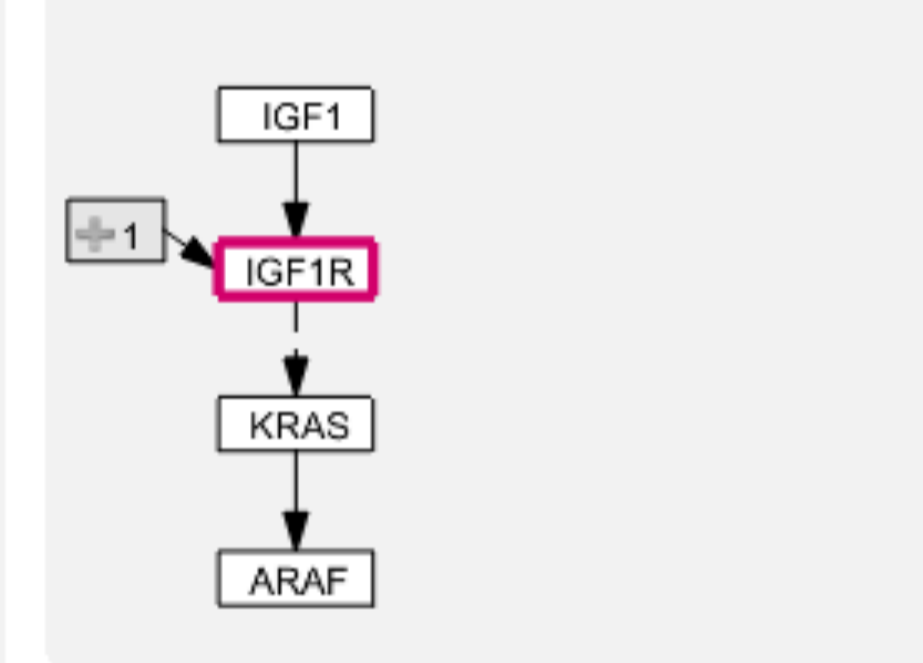

Melanoma

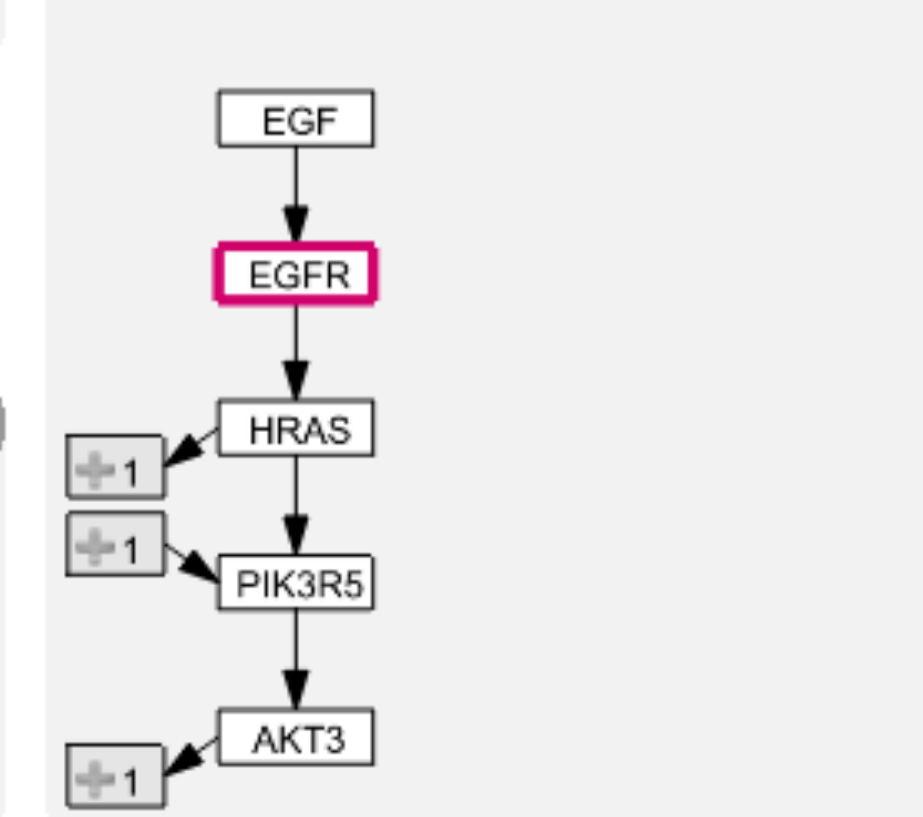

Glioma

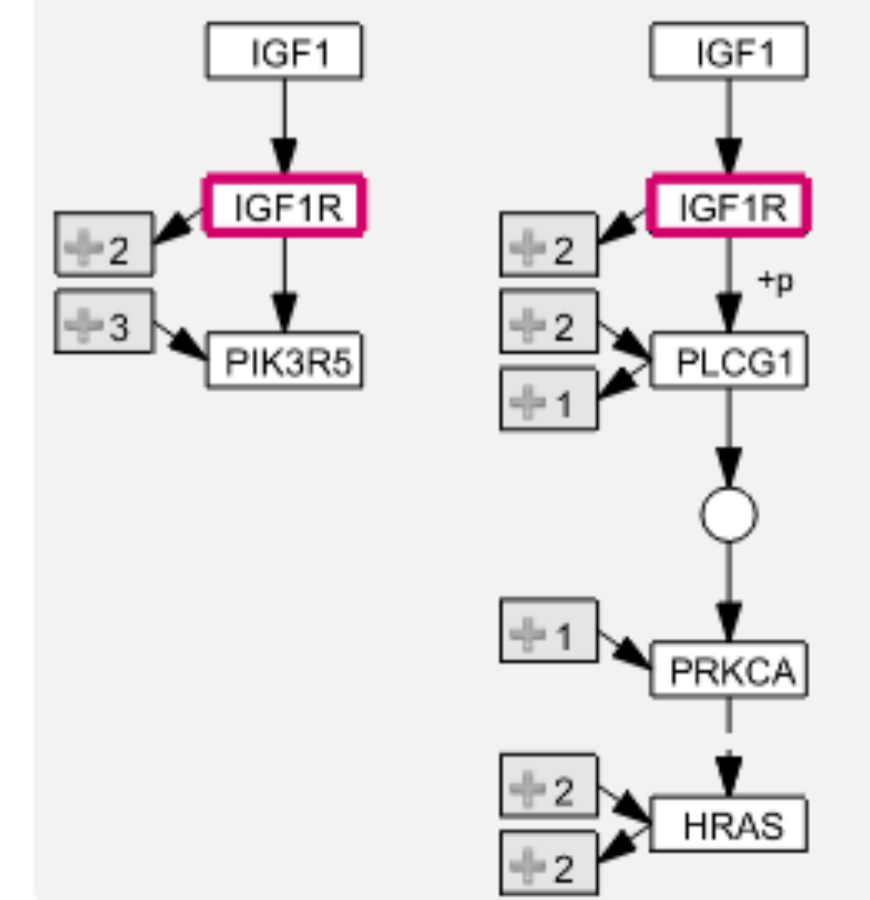
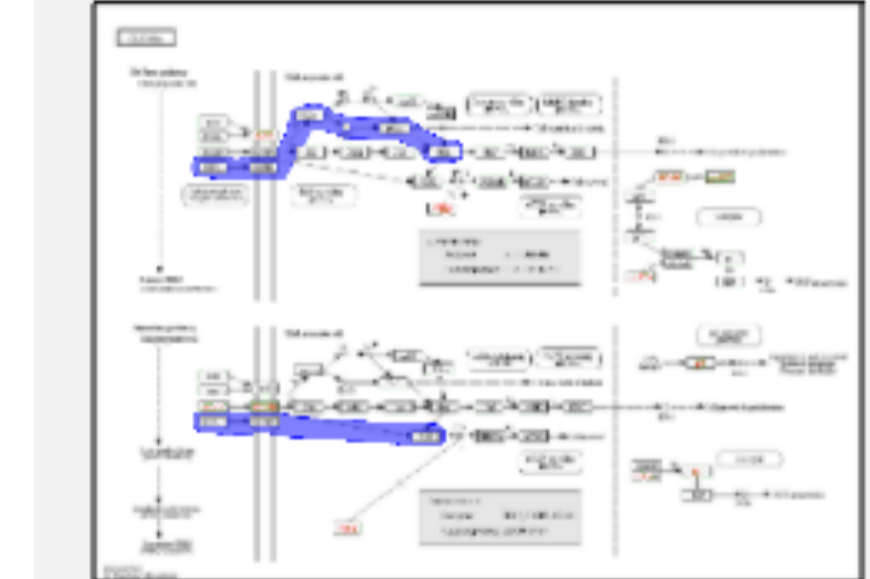

Oocyte meiosis

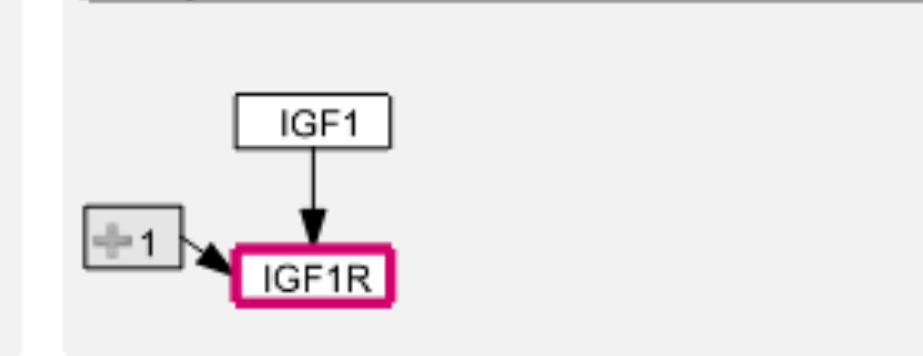

Step 3: Visualizing Relationships

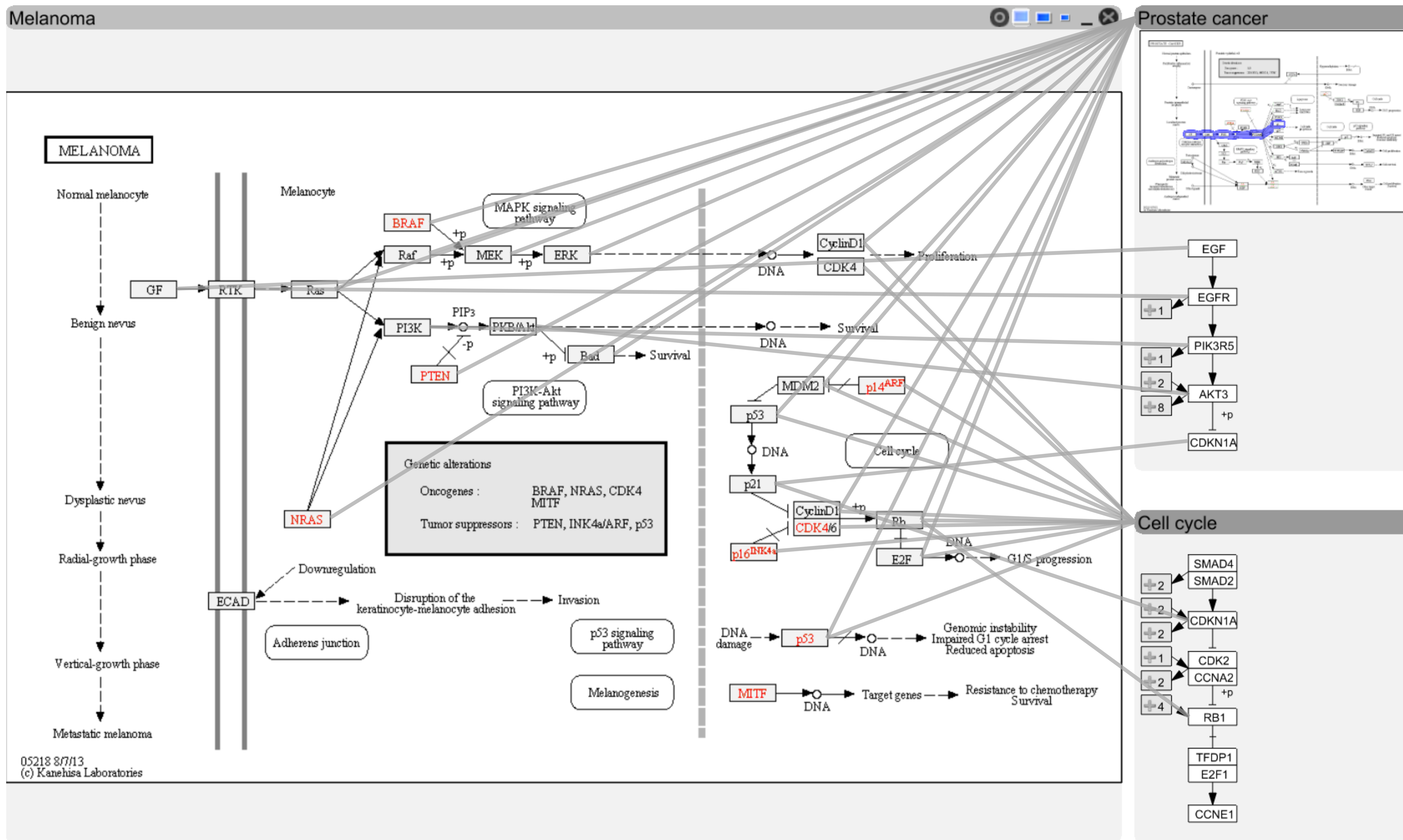

Step 3: Visualizing Relationships

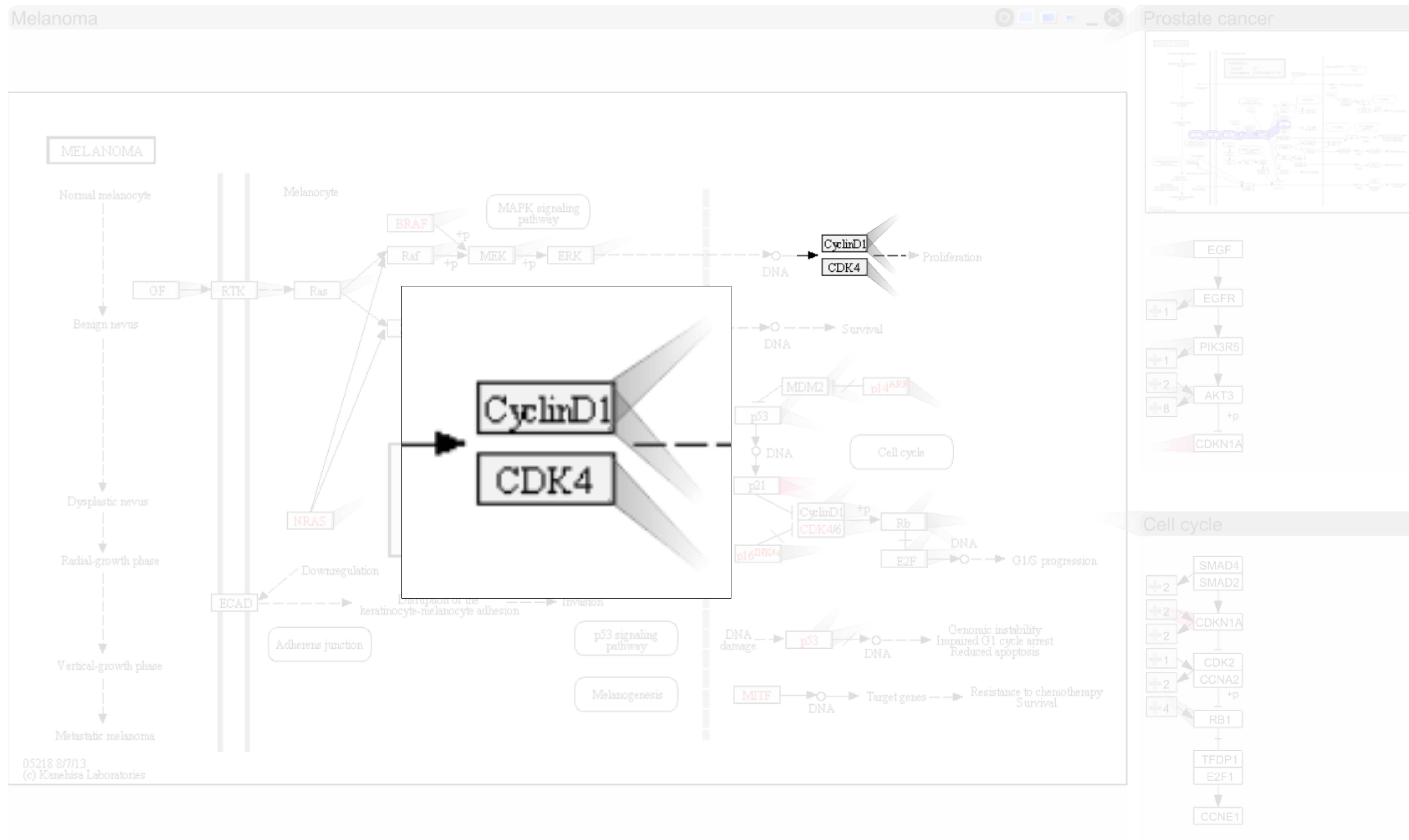

Step 3: Visualizing Relationships

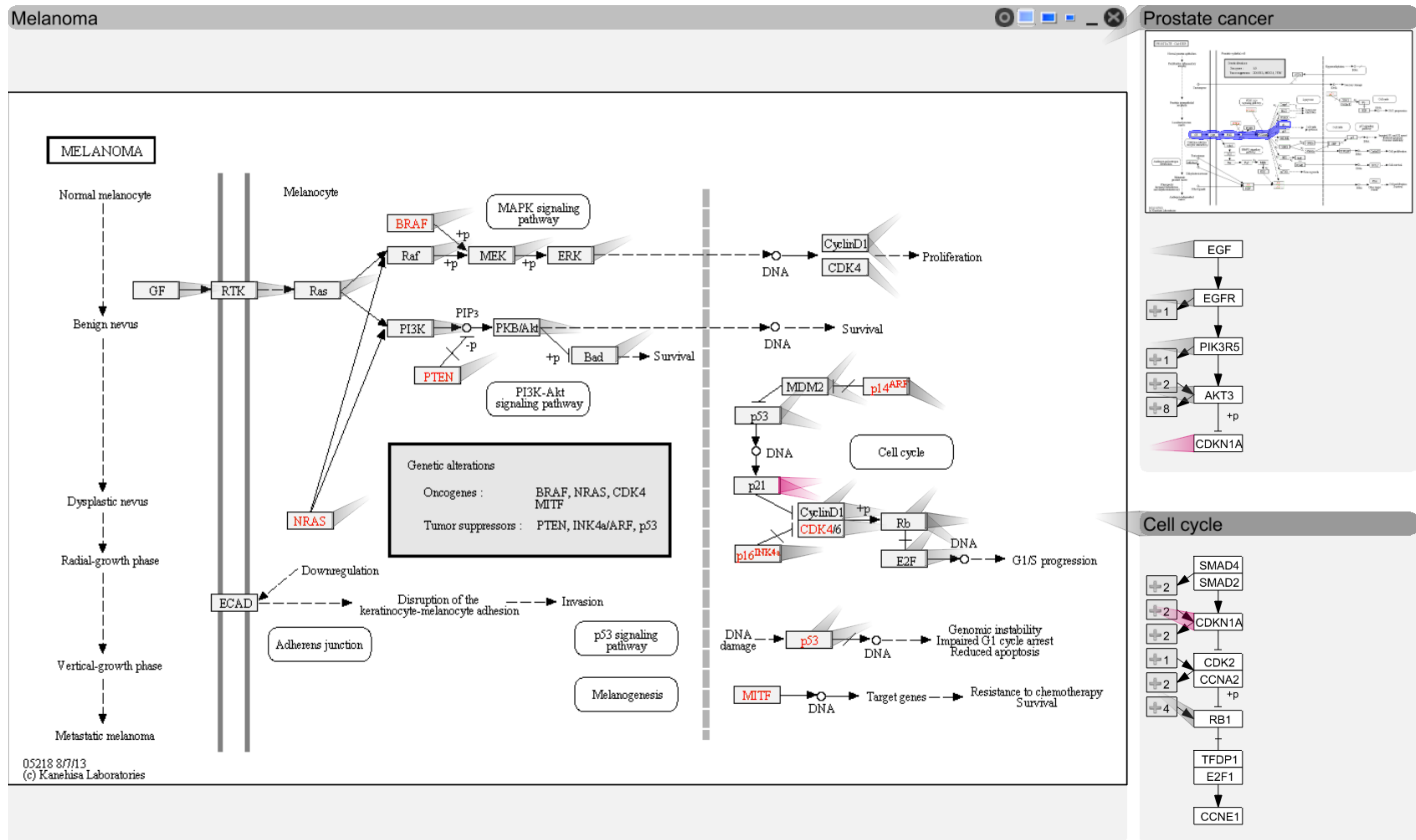

Step 3: Visualizing Relationships

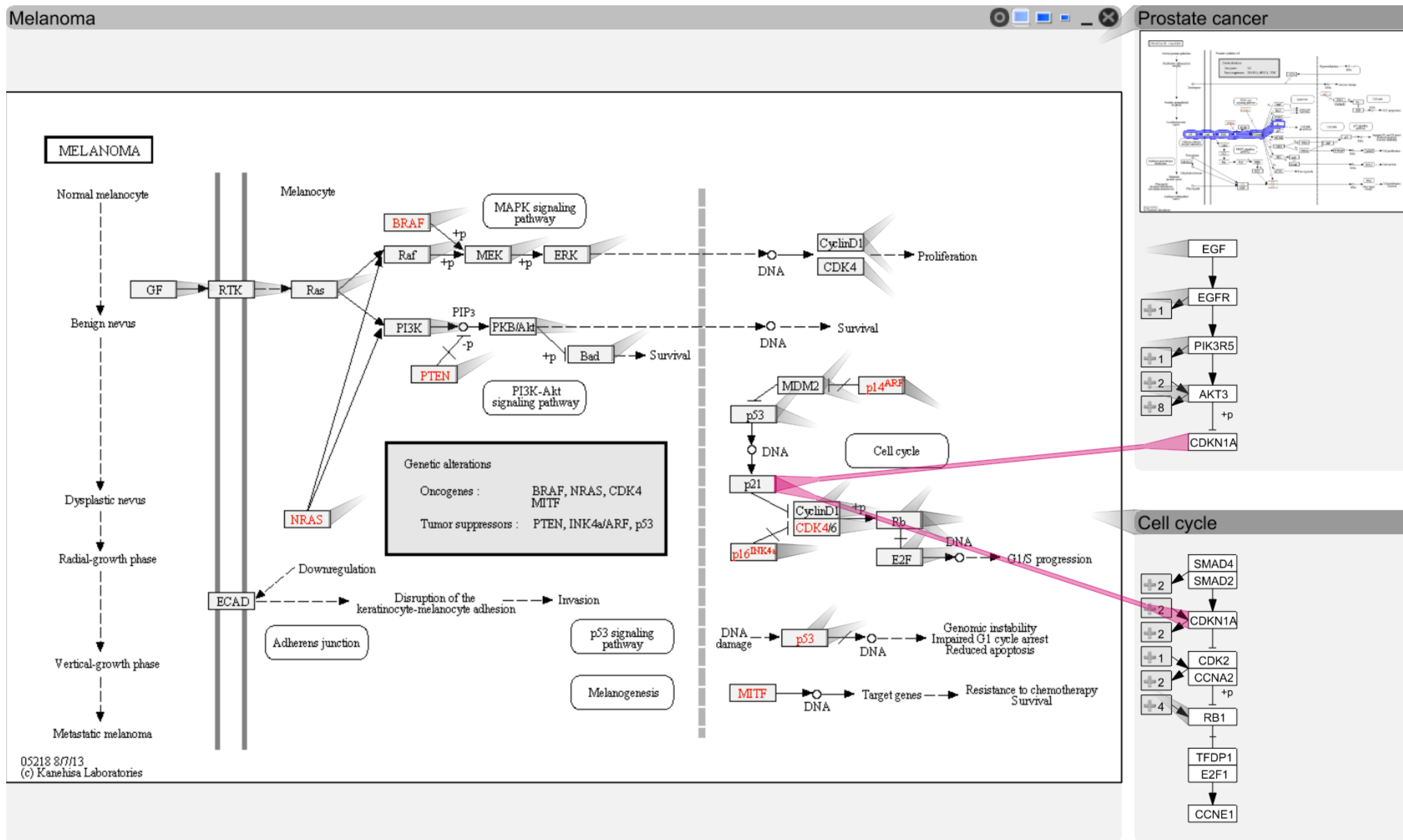

Step 3: Visualizing Relationships

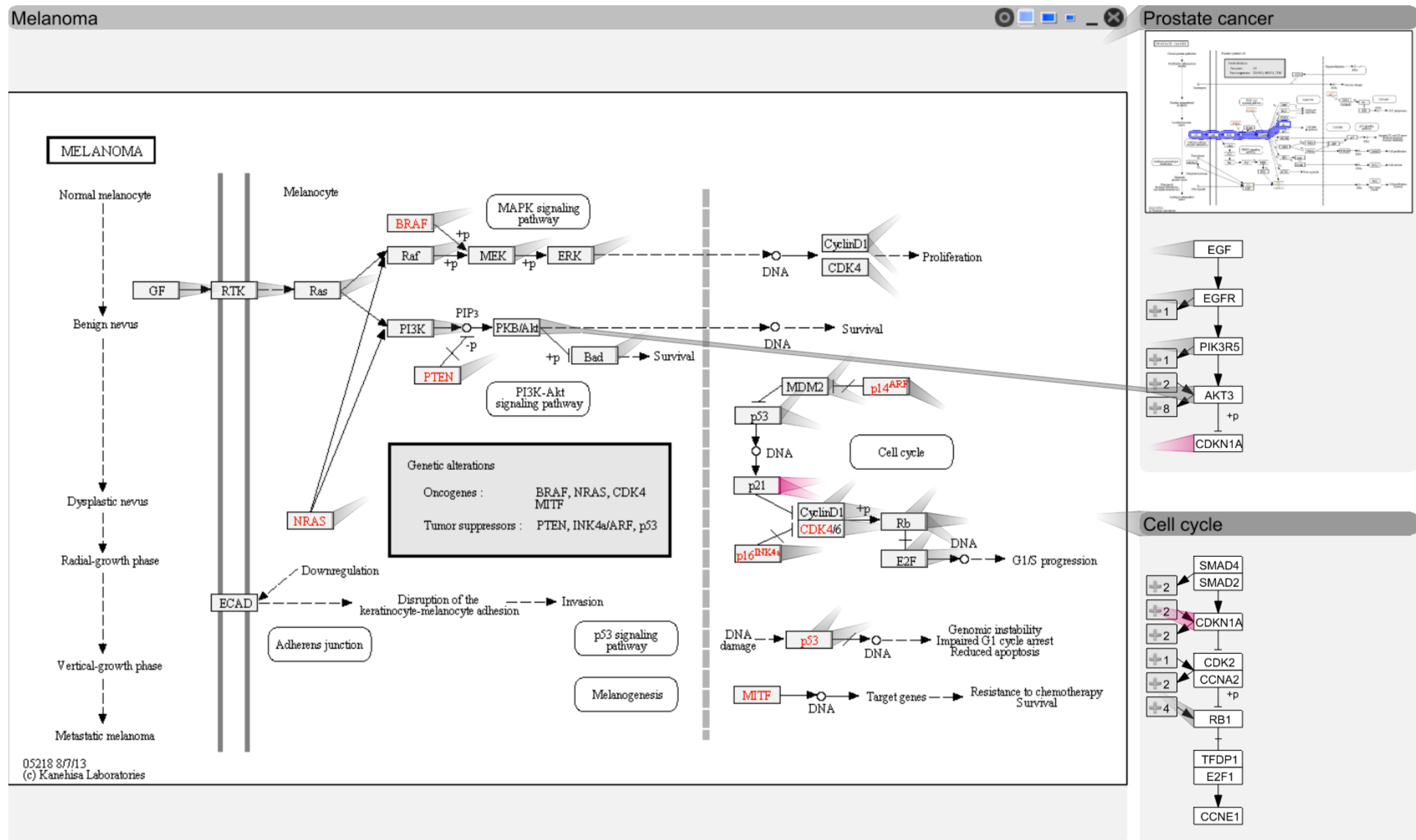

Step 3: Visualizing Relationships

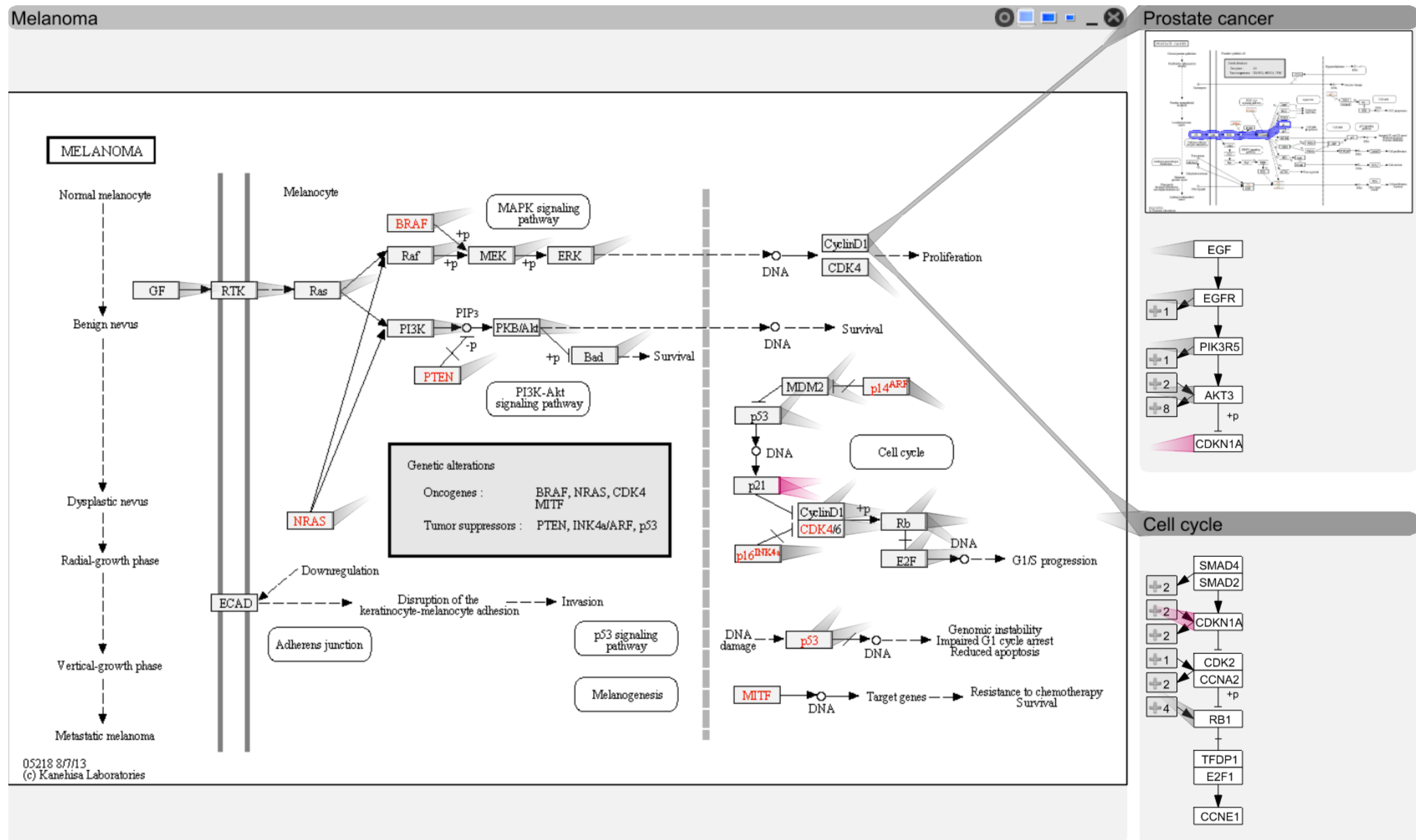

Pathways

- Pathway
- Filter:
- <None>
- 1 C donor
- 2-Oxocarboxylic acid
- ABC transporters
- ABC-family proteins
- ACE Inhibitor Pathwa
- Acetylcholine Synthes
- Acute myeloid leukem
- Adherens junction
- Adipocyte TarBase
- Adipocytokine signali
- Adipogenesis
- Advanced glycosylatio
- Aflatoxin B1 metaboli
- African trypanosomias
- AGE/RAGE pathway
- AhR pathway
- Alanine and aspartate
- Alanine, aspartate an
- Alcoholism
- Aldosterone-regulated
- Allograft rejection
- Allograft rejection
- Alpha 6 Beta 4 signal
- alpha-Linolenic acid
- Alzheimer's disease
- Alzheimers Disease
- amino acid conjugatio
- amino acid conjugatio
- Amino sugar and nucl
- Aminoacyl-tRNA bios
- Amoebiasis
- Amphetamine addicti
- AMPK signaling
- Amyotrophic lateral sc
- Androgen receptor si
- Angiogenesis
- Angiogenesis
- angiogenesis overvie
- Antigen processing an
- APC/C-mediated degra
- Apoptosis
- Apoptosis
- Apoptosis Meta Path
- Apoptosis Modulation
- Apoptosis Modulation
- Apoptosis, anoikis an

Selected Path

Area for displaying the details of the selected pathway.



Visualizing Many Node Attributes

Experi- mental Data and Pathways

[PartI, BioVis '12]

Cannot account for **variation** found in
real-world data

Branches can be **(in)activated** due to
mutation,
changed gene expression,
modulation due to drug treatment,
etc.

Good Old Color Coding

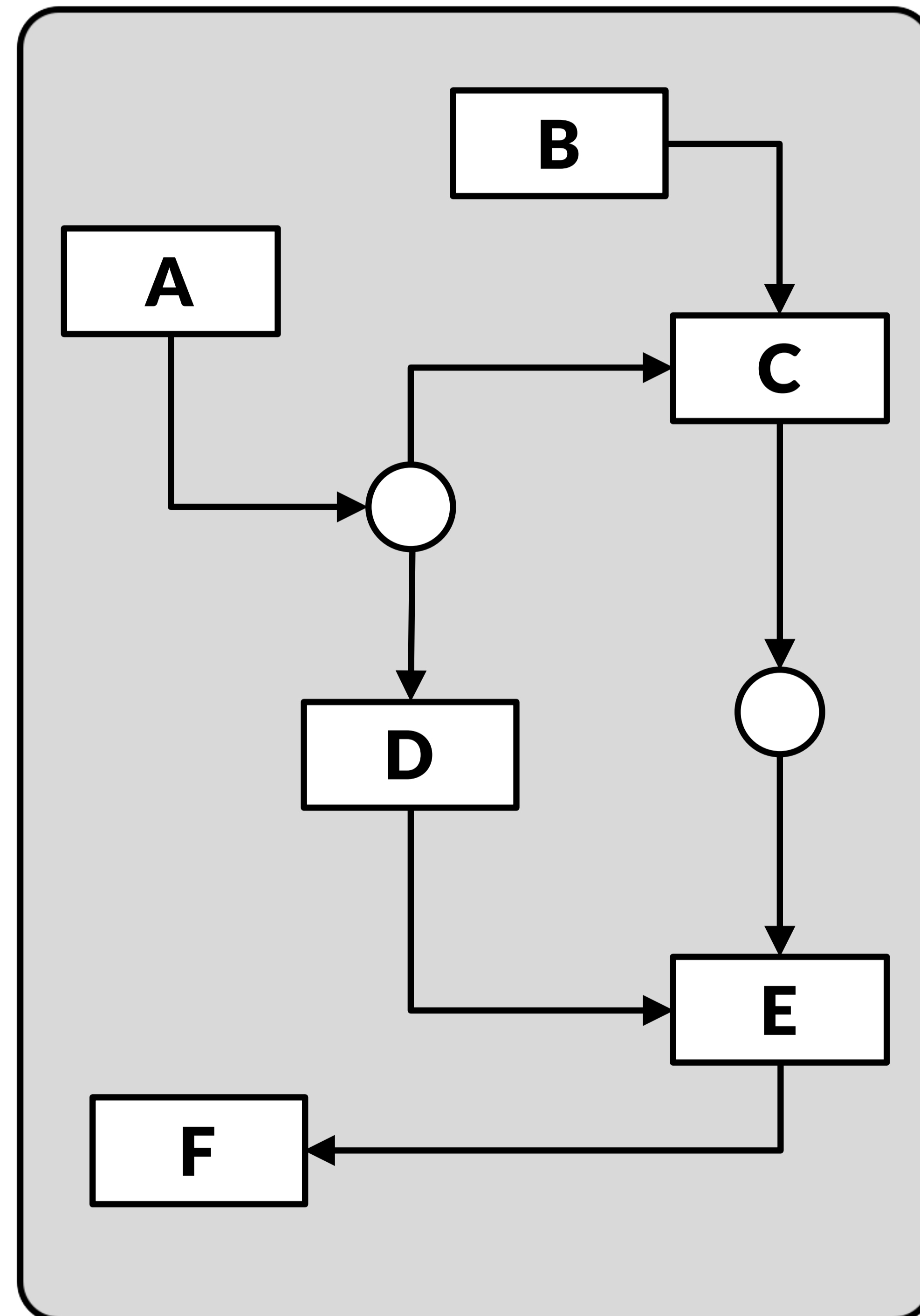

A	-3.4	4.2	5.1	4.2
B	2.8	1.8	1.3	1.1
C	3.1	-2.2	2.4	2.2
D	-3	-2.8	1.6	1.0
E	0.5	0.3	-1.1	1.3
F	0.3	0.3	1.8	-0.3

[Lindroos2002]

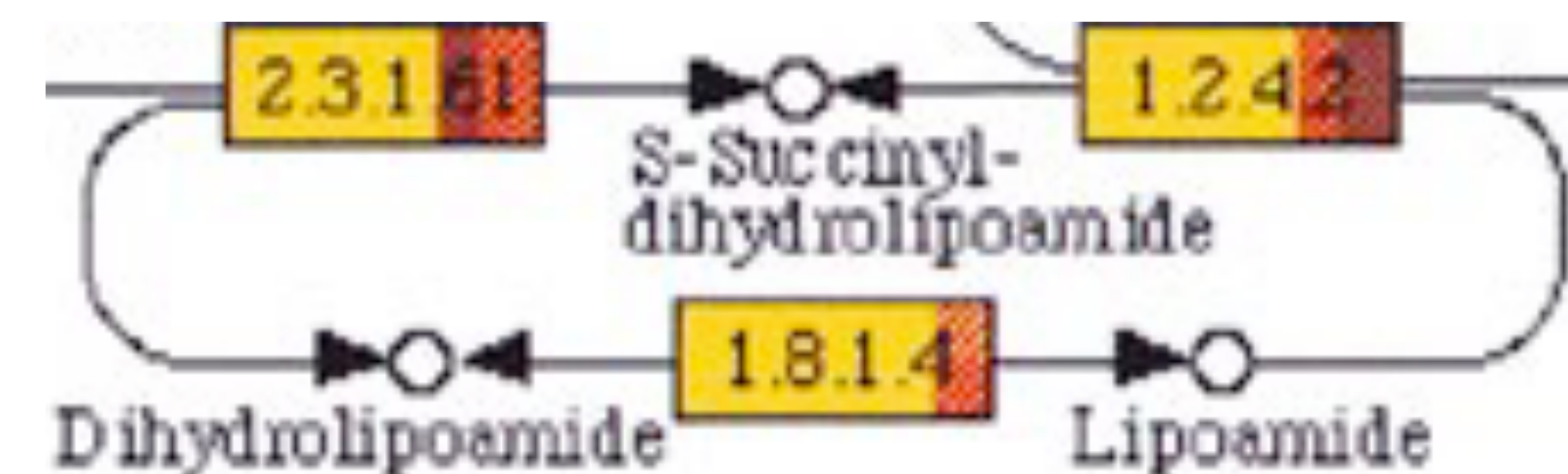

Challenge: Data Scale & Heterogeneity

Large **number of experiments**

Large datasets have more than 500 experiments

Multiple **groups/conditions**

Different **types** of data

Challenge: Supporting Multiple Tasks

Two central tasks:

Explore **topology** of pathway

Explore the **attributes** of the nodes
(experimental data)

Need to support both!

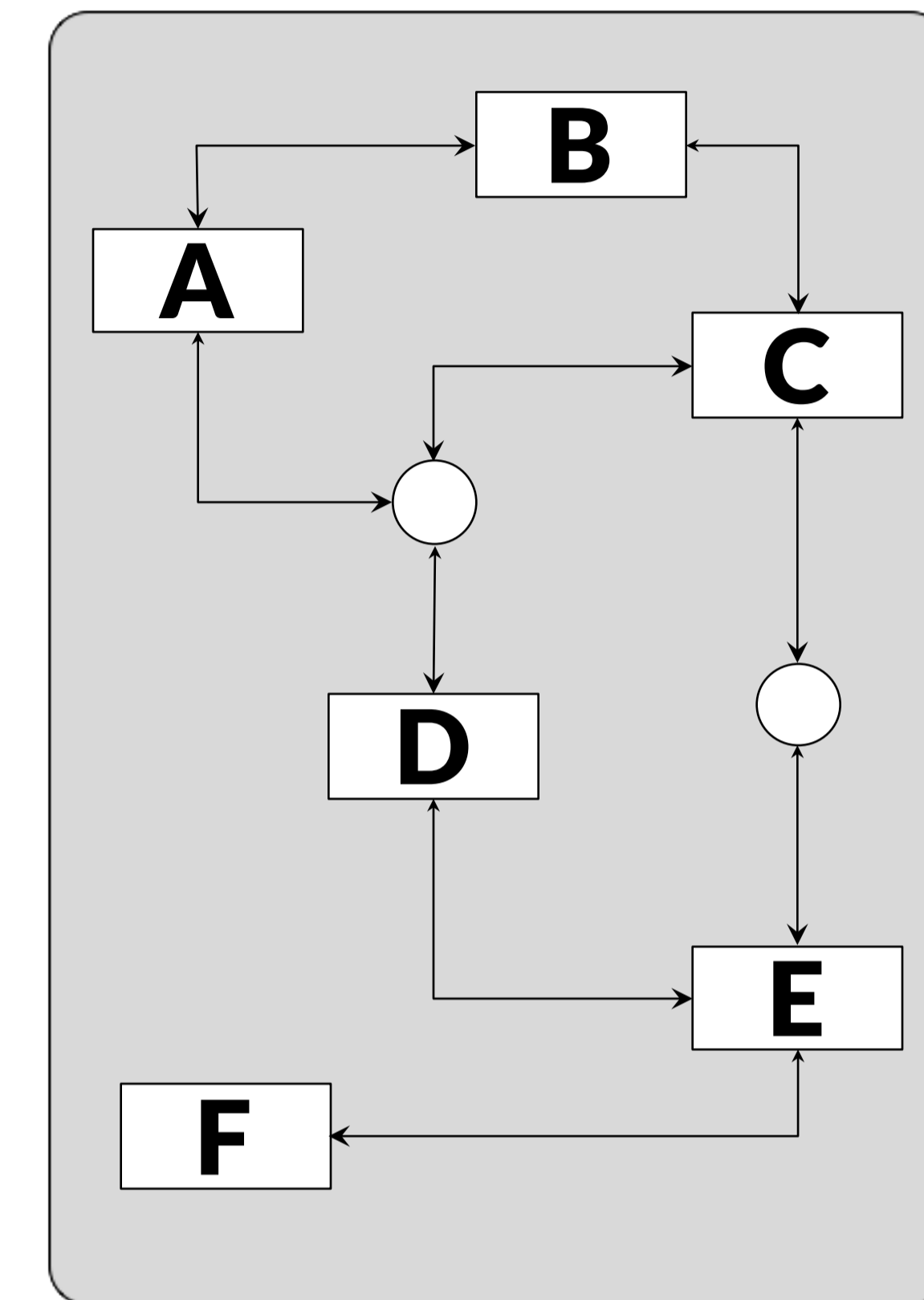

	Sample 1	Sample 2	Sample 3
Gene 1	1	1.1	0.4
Gene 2	2	0.5	1.2
Gene 3	1.4	0.2	0.5
Gene 4	0.3	0.5	0.7

Inspiration

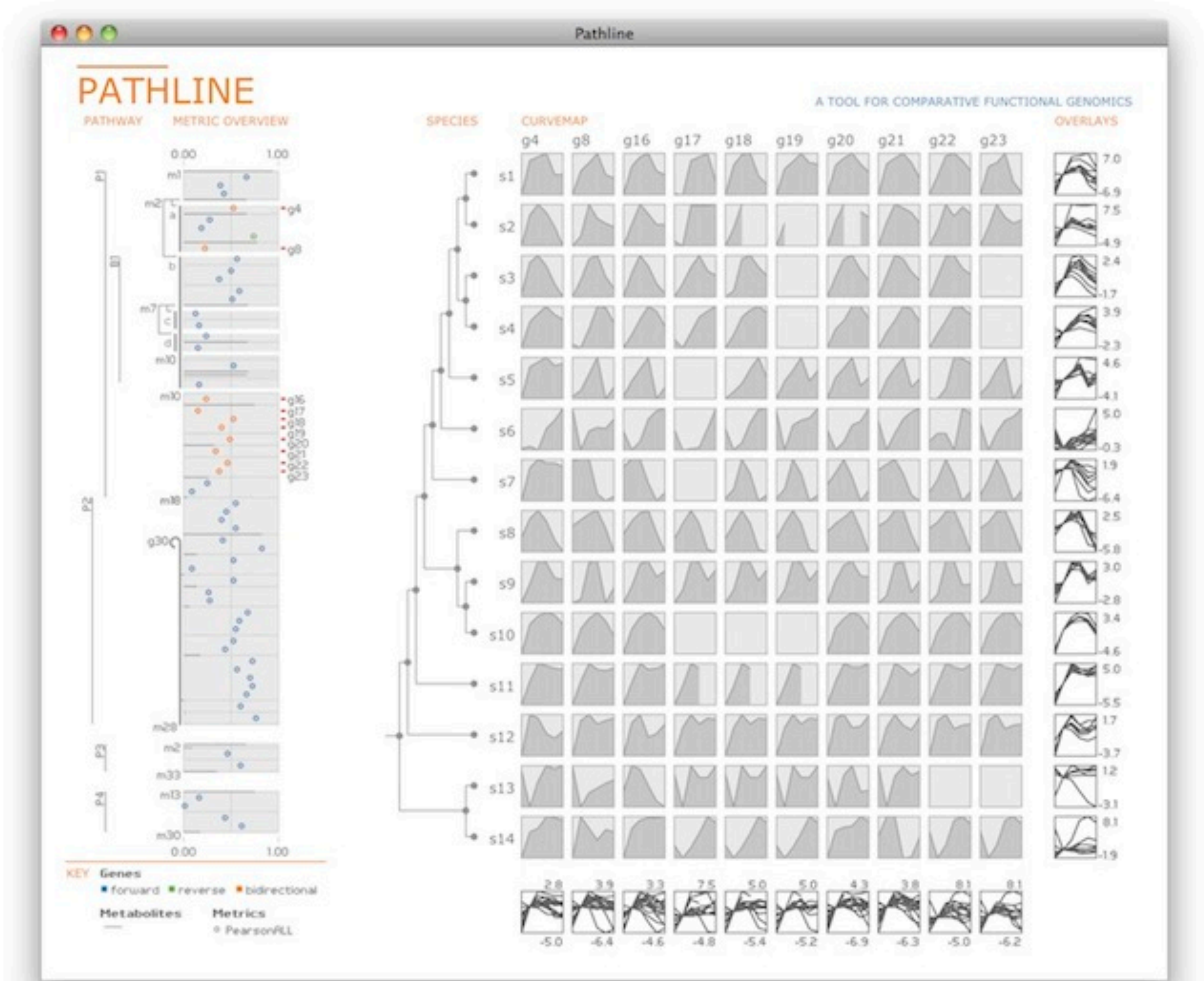

[Meyer 2010]

Concept

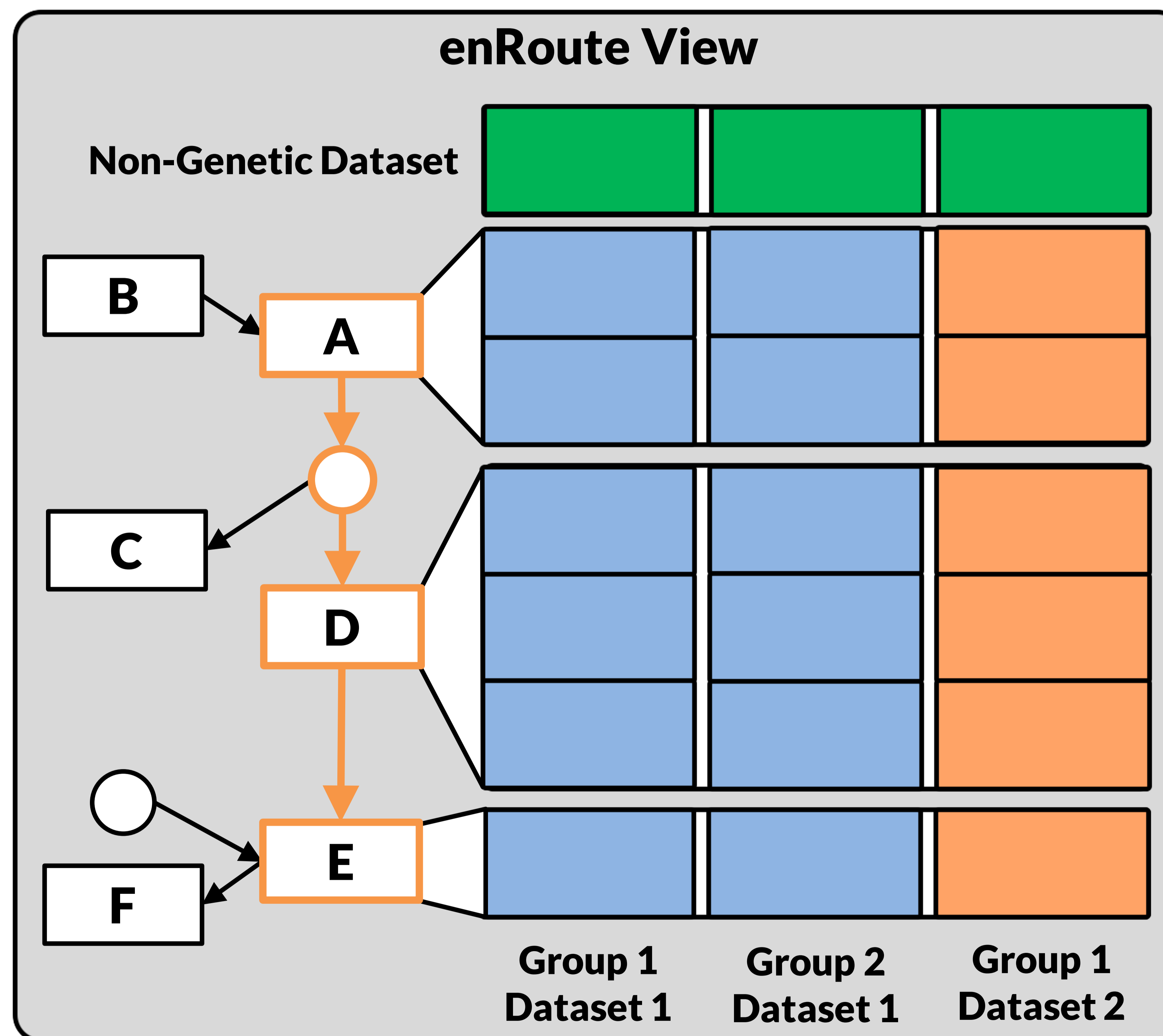
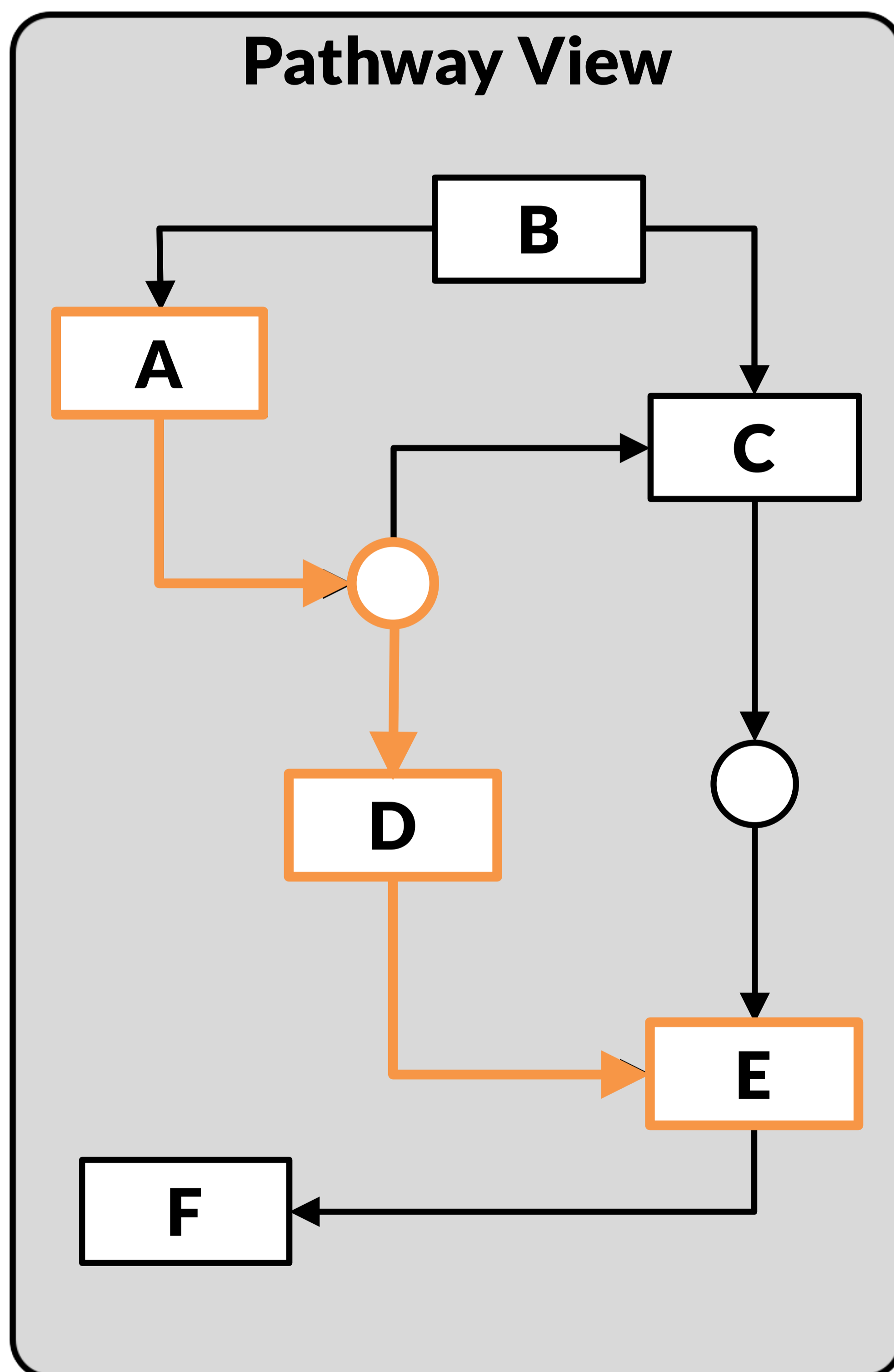

enRoute

Melanogenesis

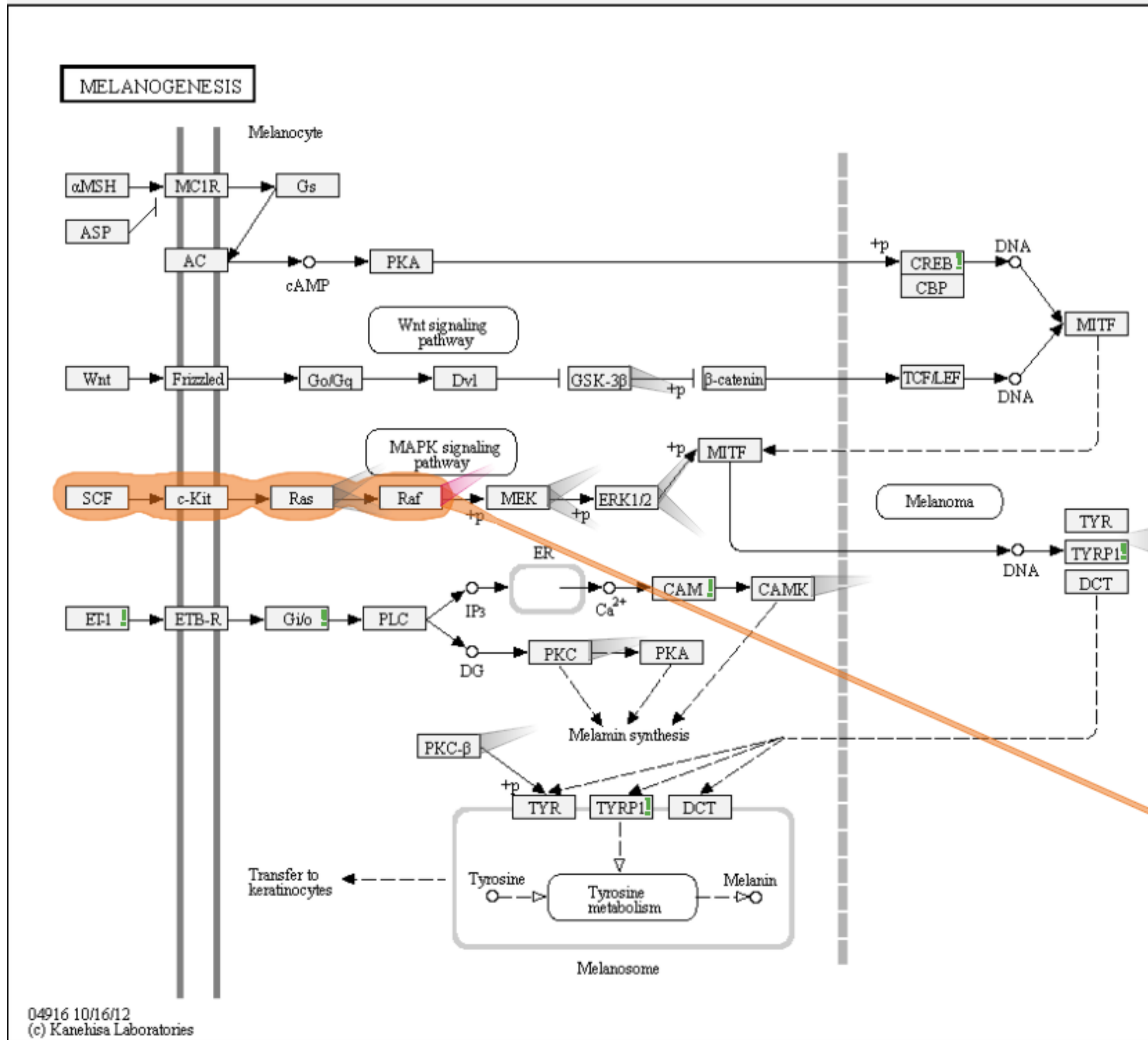

Pancreatic cancer

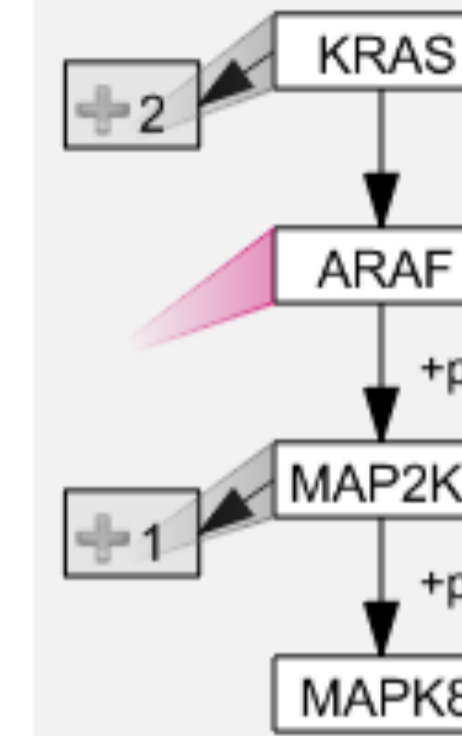

ErbB signaling pathway

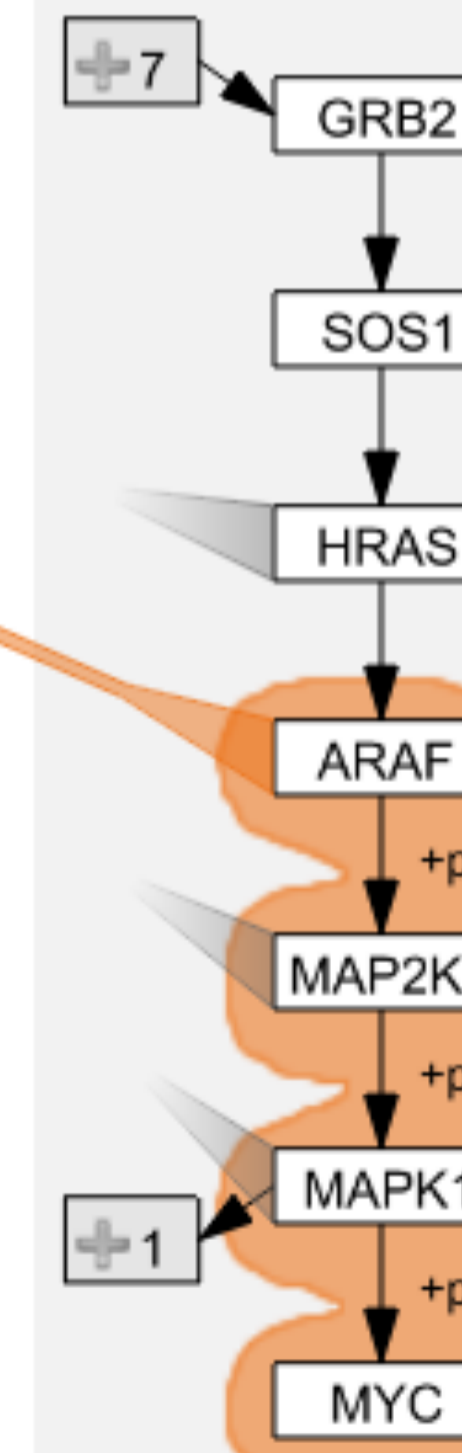

Selected Path

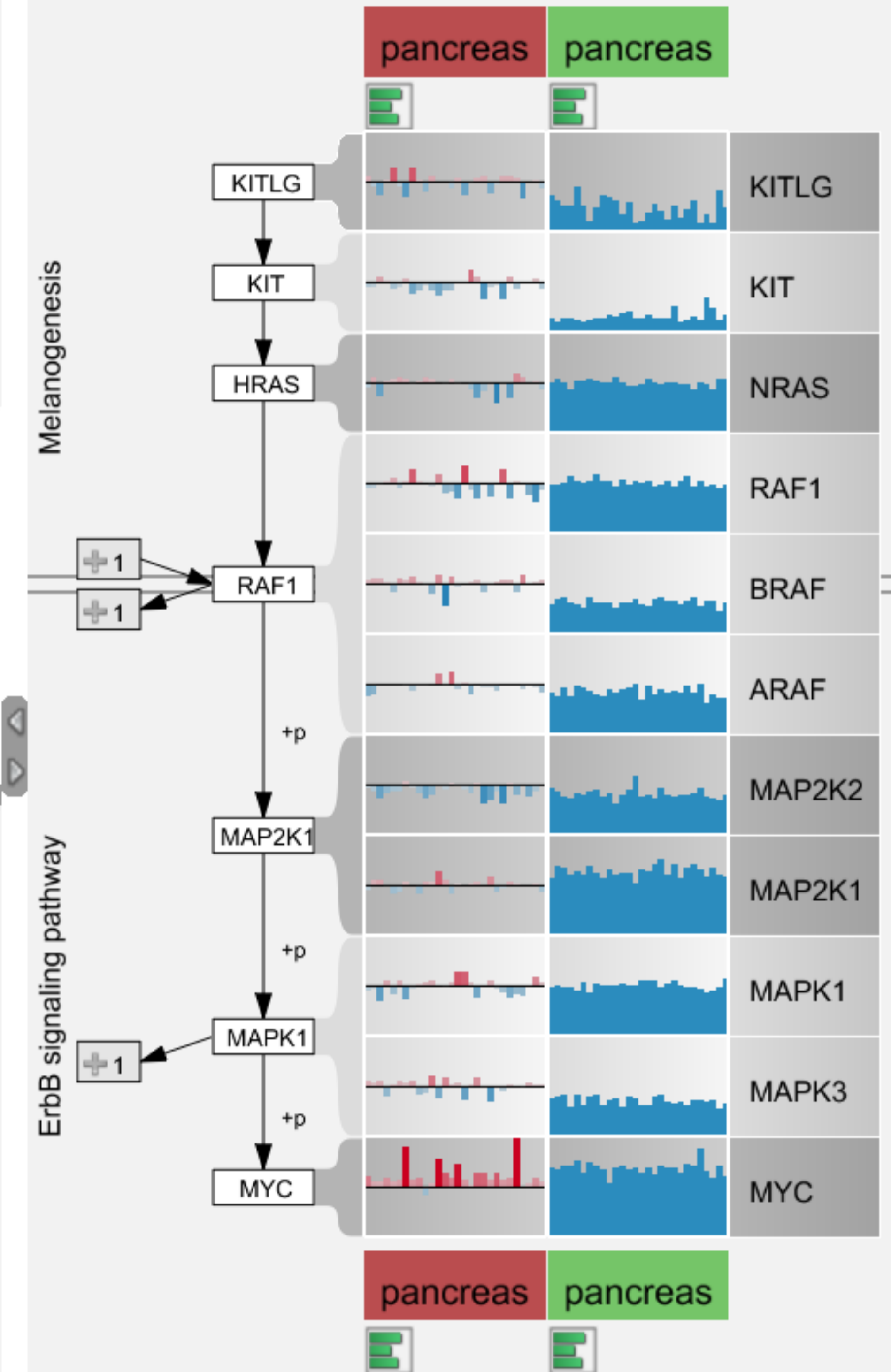

Pathways

- Pathway
- Filter:
- <None>
- 1 C donor
- 2-Oxocarboxylic acid
- ABC transporters
- ABC-family proteins
- ACE Inhibitor Pathwa
- Acetylcholine Synthes
- Acute myeloid leukem
- Adherens junction
- Adipocyte TarBase
- Adipocytokine signali
- Adipogenesis
- Advanced glycosylatio
- Aflatoxin B1 metaboli
- African trypanosomias
- AGE/RAGE pathway
- AhR pathway
- Alanine and aspartate
- Alanine, aspartate an
- Alcoholism
- Aldosterone-regulated
- Allograft rejection
- Allograft rejection
- Alpha 6 Beta 4 signal
- alpha-Linolenic acid
- Alzheimer's disease
- Alzheimers Disease
- amino acid conjugatio
- amino acid conjugatio
- Amino sugar and nucl
- Aminoacyl-tRNA bios
- Amoebiasis
- Amphetamine addicti
- AMPK signaling
- Amyotrophic lateral sc
- Androgen receptor si
- Angiogenesis
- Angiogenesis
- angiogenesis overvie
- Antigen processing an
- APC/C-mediated degra
- Apoptosis
- Apoptosis
- Apoptosis Meta Path
- Apoptosis Modulation
- Apoptosis Modulation
- Apoptosis, anoikis an

Selected Path

Area for displaying the details of the selected pathway.



Pathway List

Focus Pathway

Context Pathways

enRoute View

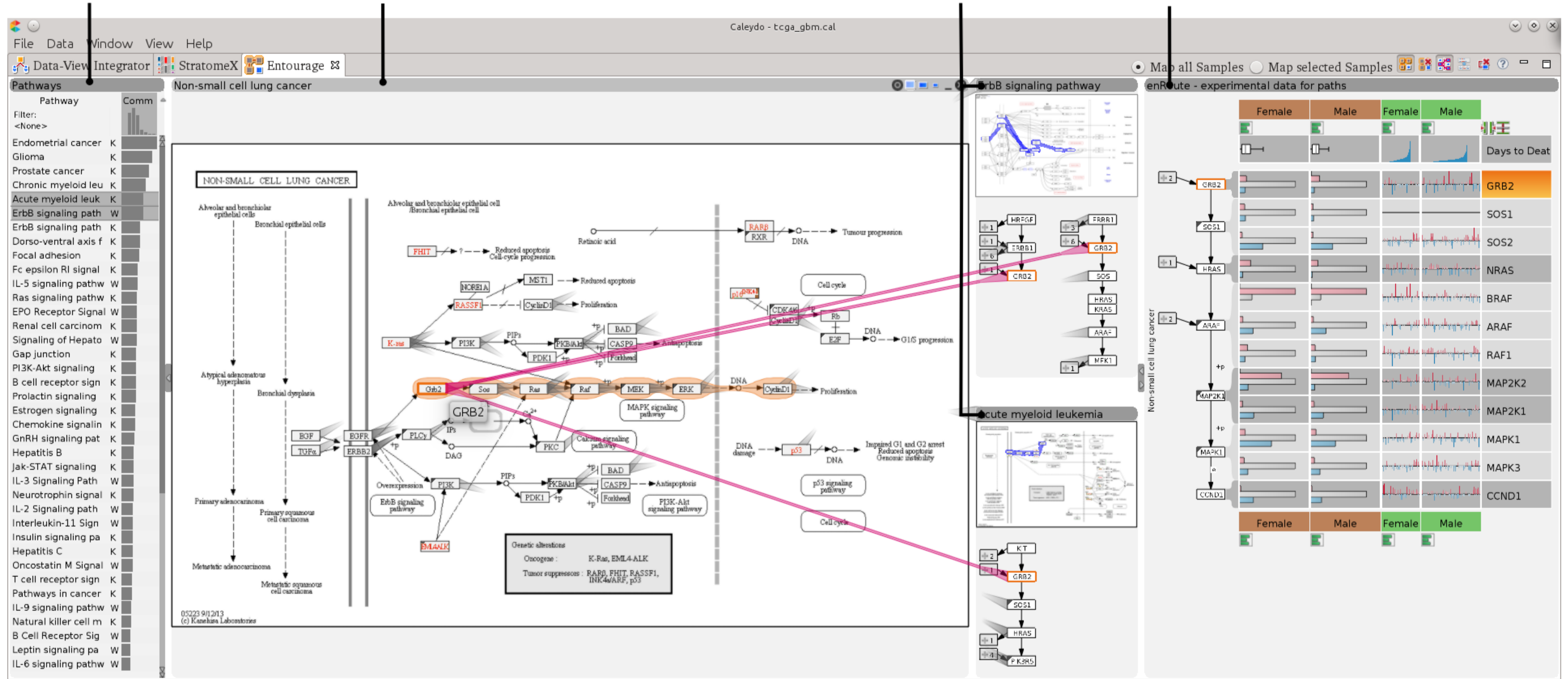

Stratifications - LineUp | **Non-Genetic - LineUp**

Mapping Datasets

- Map onto Pathway
- Map in enRoute
- None
- RPPA
- Mutations
- mRNA-seq
- Copy Number
- mRNA
- Methylation

Stratification

Filter Stratifications

- Methylation
- microRNA
- mRNA
- mRNA-seq
- RPPA
- Clinical
- Copy Number
- Mutations

Ra	Stratification
1.	Ethnicity
2.	Gender
3.	Histological Type
4.	Race
5.	Tumor Tissue Site
6.	Vital Status

Groups

- Select None
- Group
- Size
- Female: 223
- Male: 351

enRoute - experimental data for paths

Gene	Female	Male	Female	Male
GRB2	Bar chart	Bar chart	Line graph	Line graph
SOS1	Bar chart	Bar chart	Line graph	Line graph
HRAS	Bar chart	Bar chart	Line graph	Line graph
BRAF	Bar chart	Bar chart	Line graph	Line graph
ARAF	Bar chart	Bar chart	Line graph	Line graph
RAF1	Bar chart	Bar chart	Line graph	Line graph
MAP2K2	Bar chart	Bar chart	Line graph	Line graph
MAP2K1	Bar chart	Bar chart	Line graph	Line graph
MAPK1	Bar chart	Bar chart	Line graph	Line graph
MAPK3	Bar chart	Bar chart	Line graph	Line graph
CCND1	Bar chart	Bar chart	Line graph	Line graph

Experimental Data Assignment

Case Study: CCLE Data

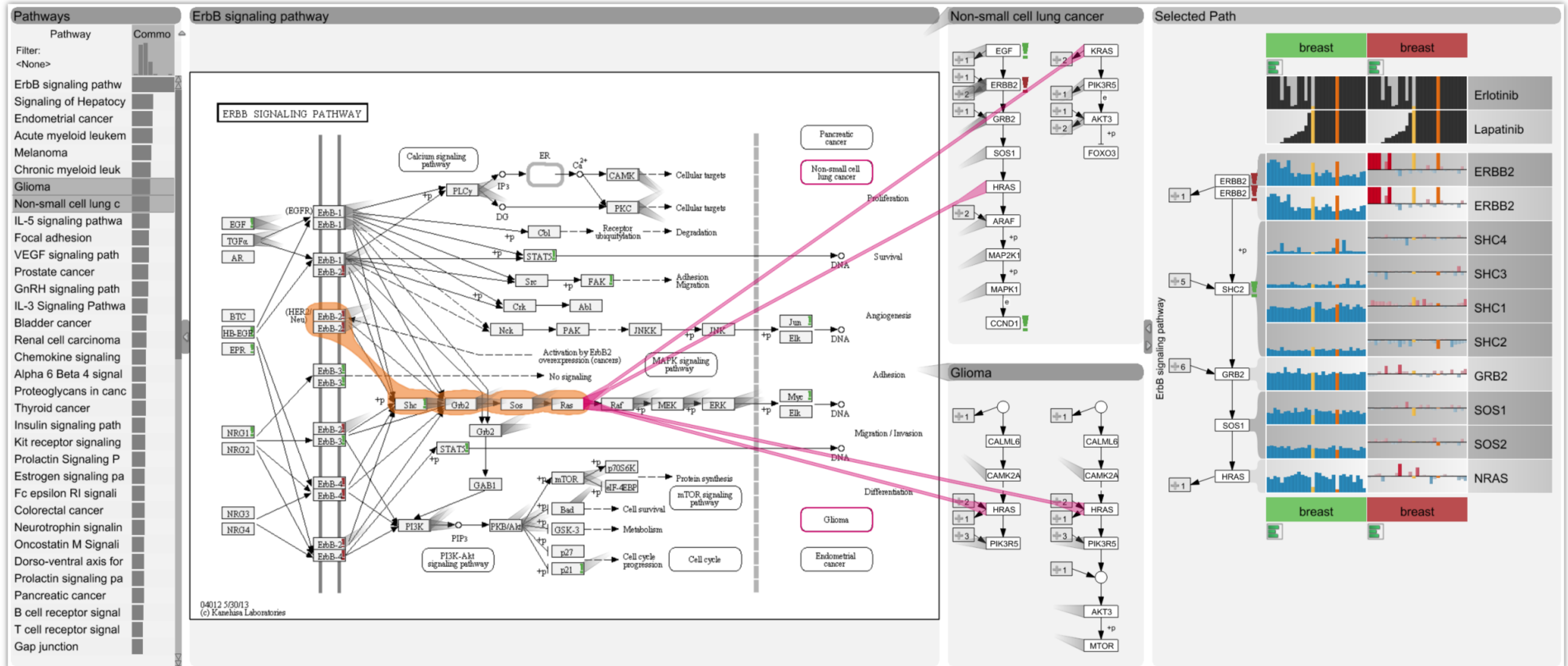

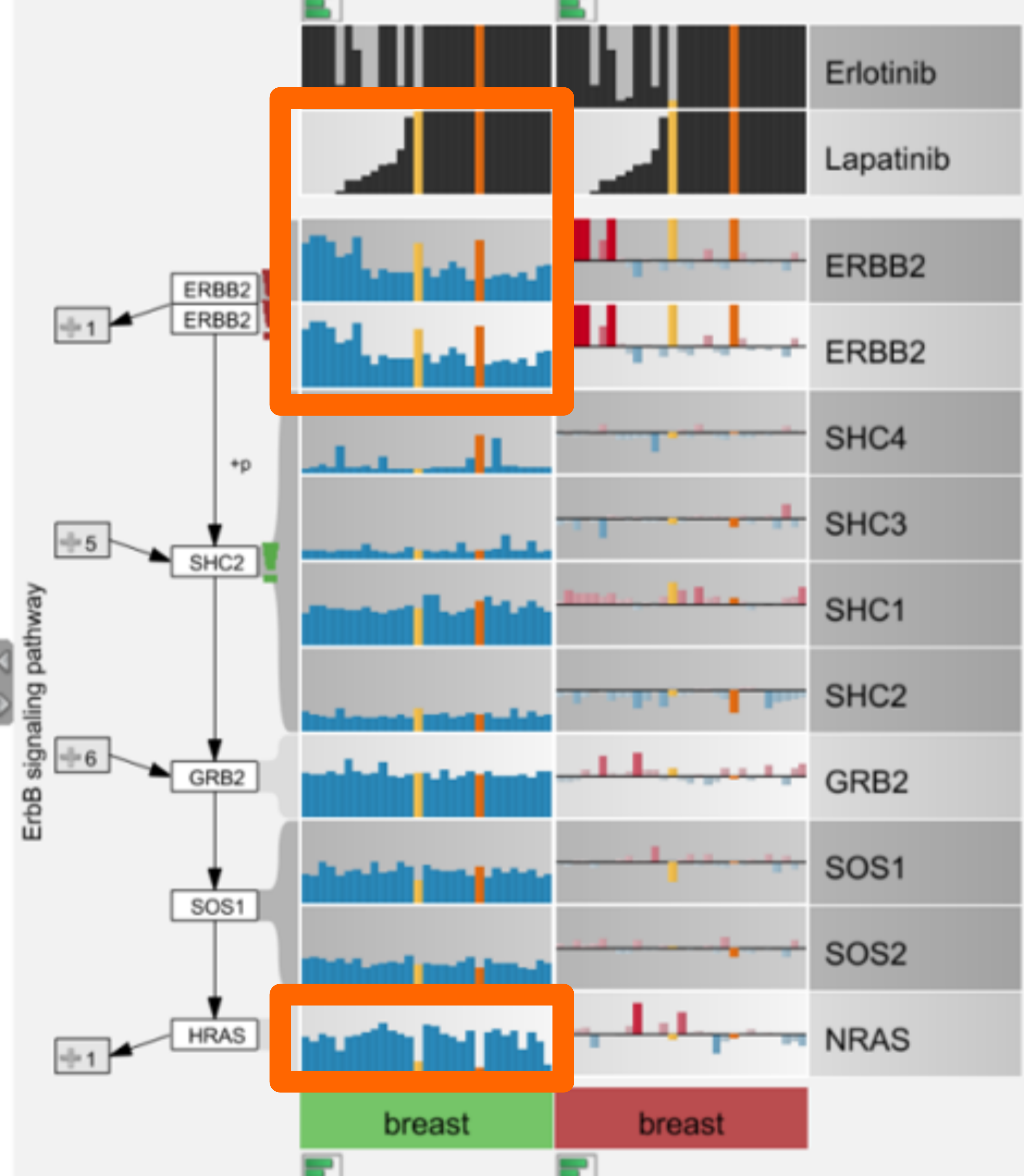
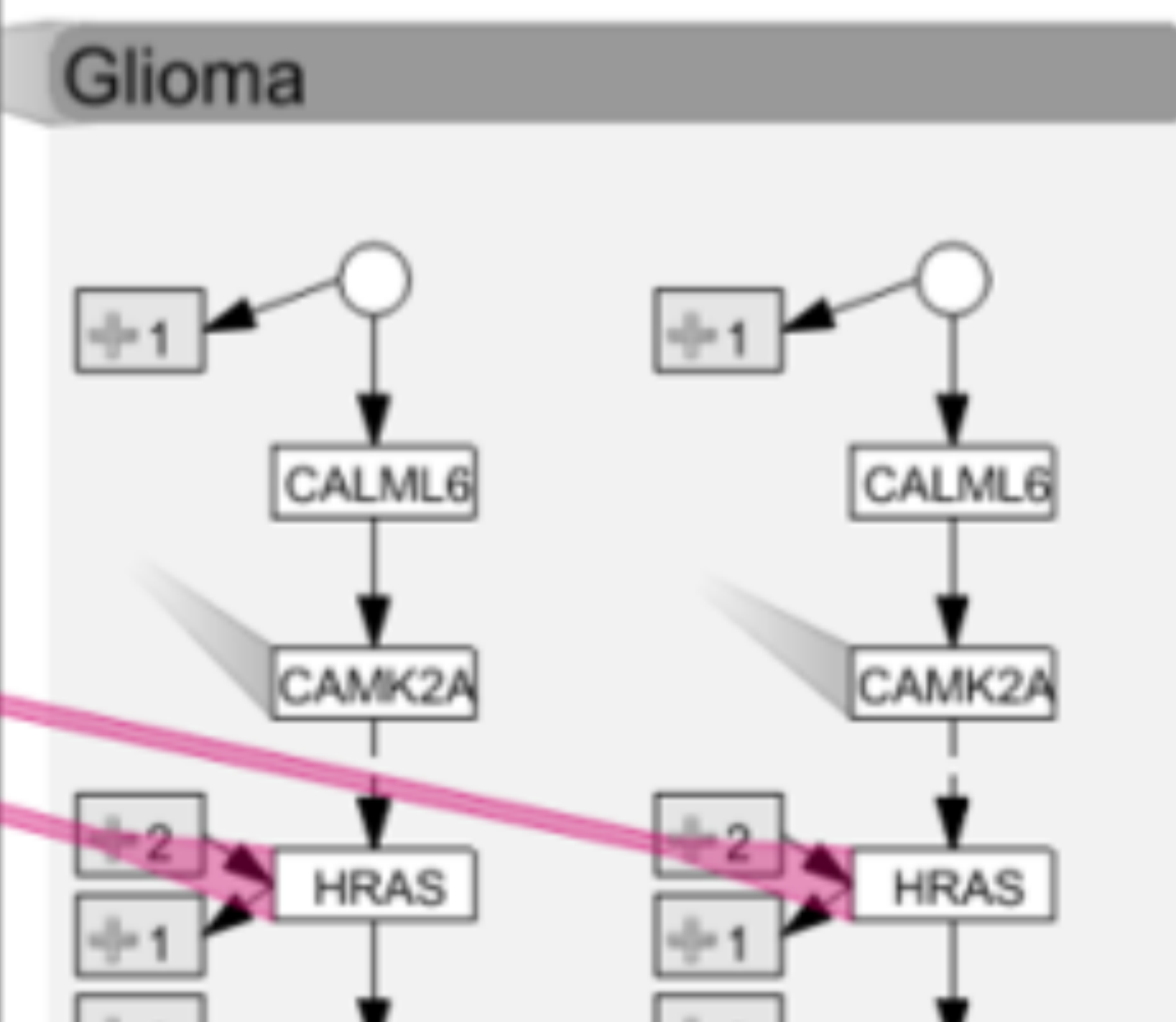
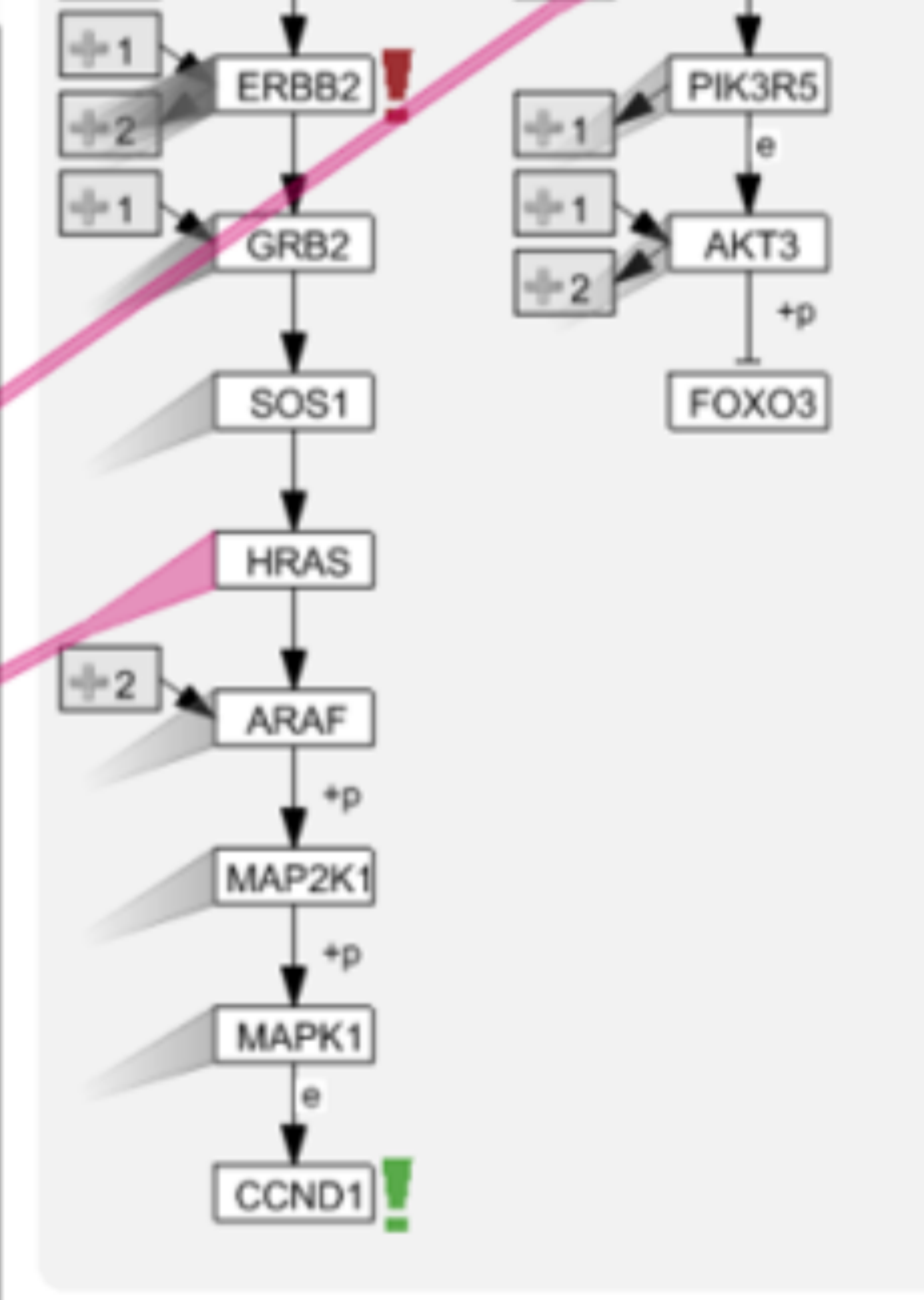

<http://entourage.caleydo.org>

Other Techniques

Creating Integrated Visualizations from Subsets

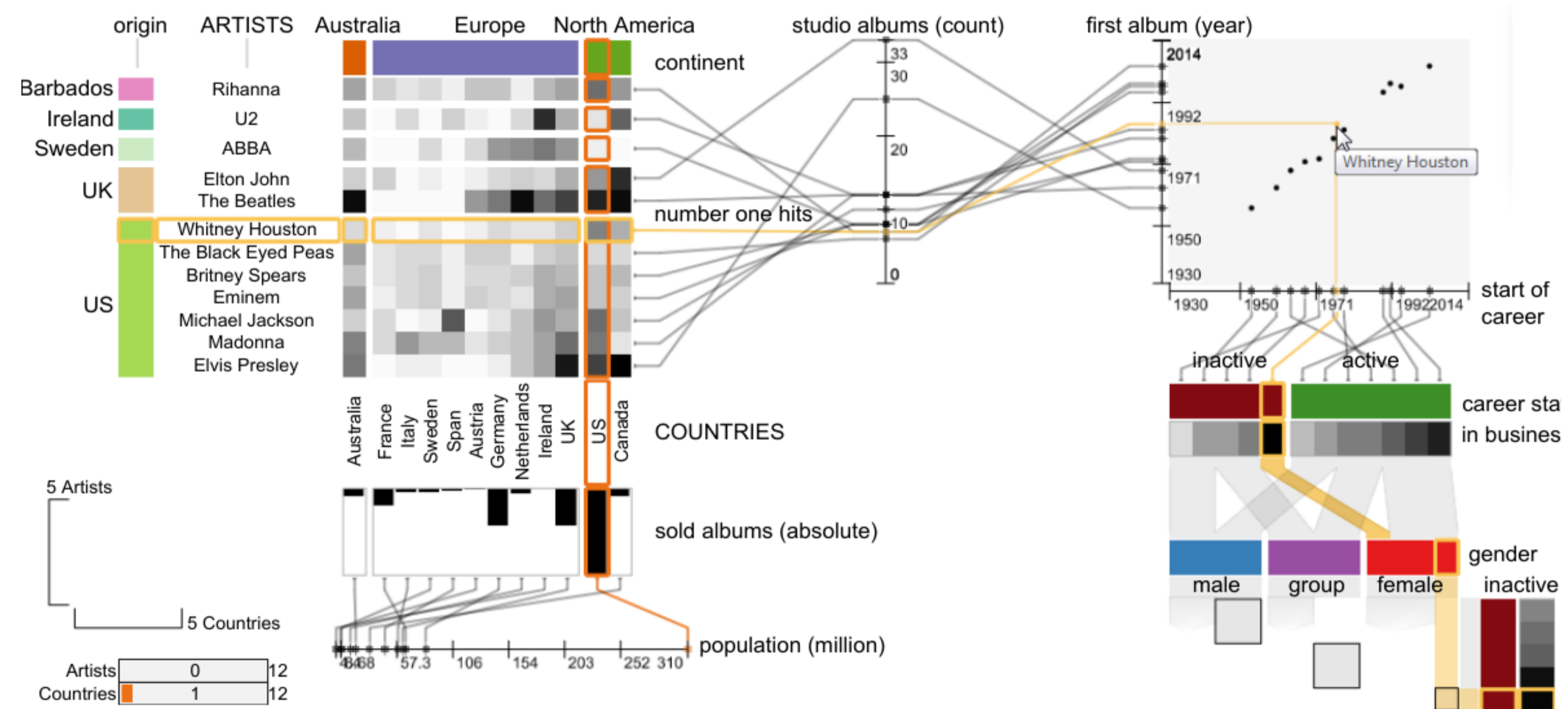

IEEE TVCG (InfoVis '14)
HONORABLE MENTION AWARD

Visualizing Hidden Content

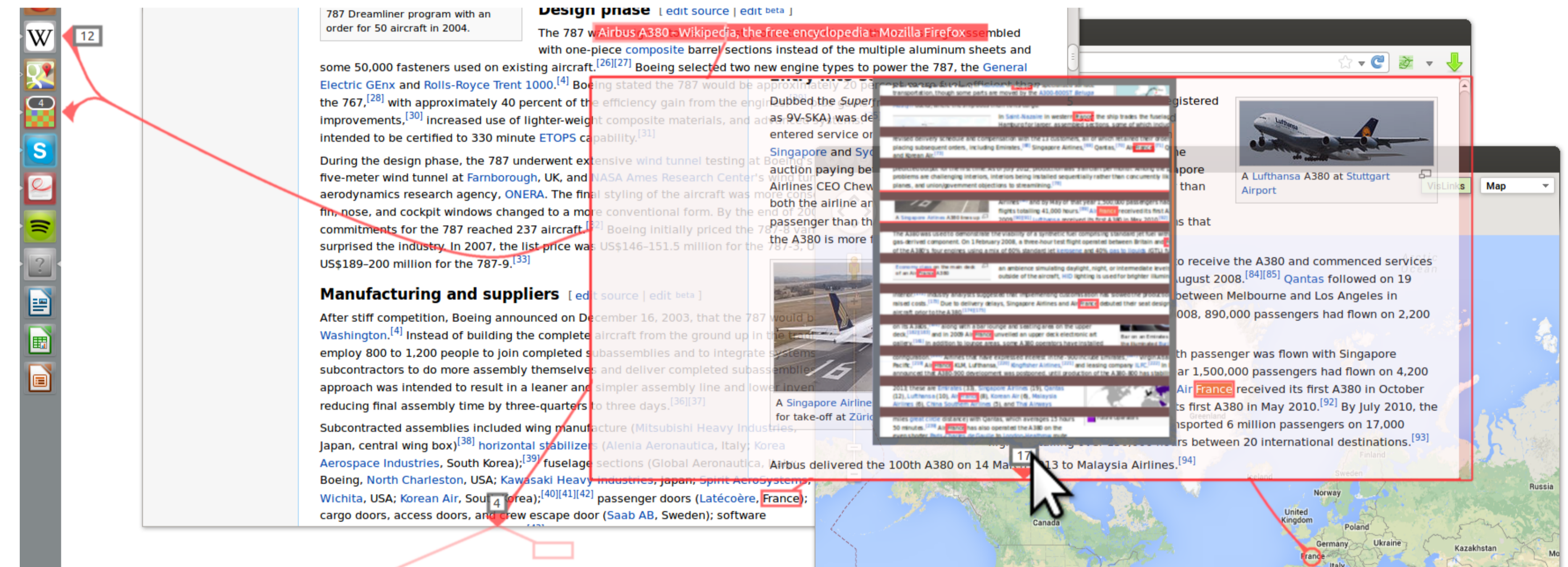

ACM CHI'14
HONORABLE MENTION AWARD

Other Domain Problem Projects

Heterogeneous Datasets Cancer Subtype Analysis

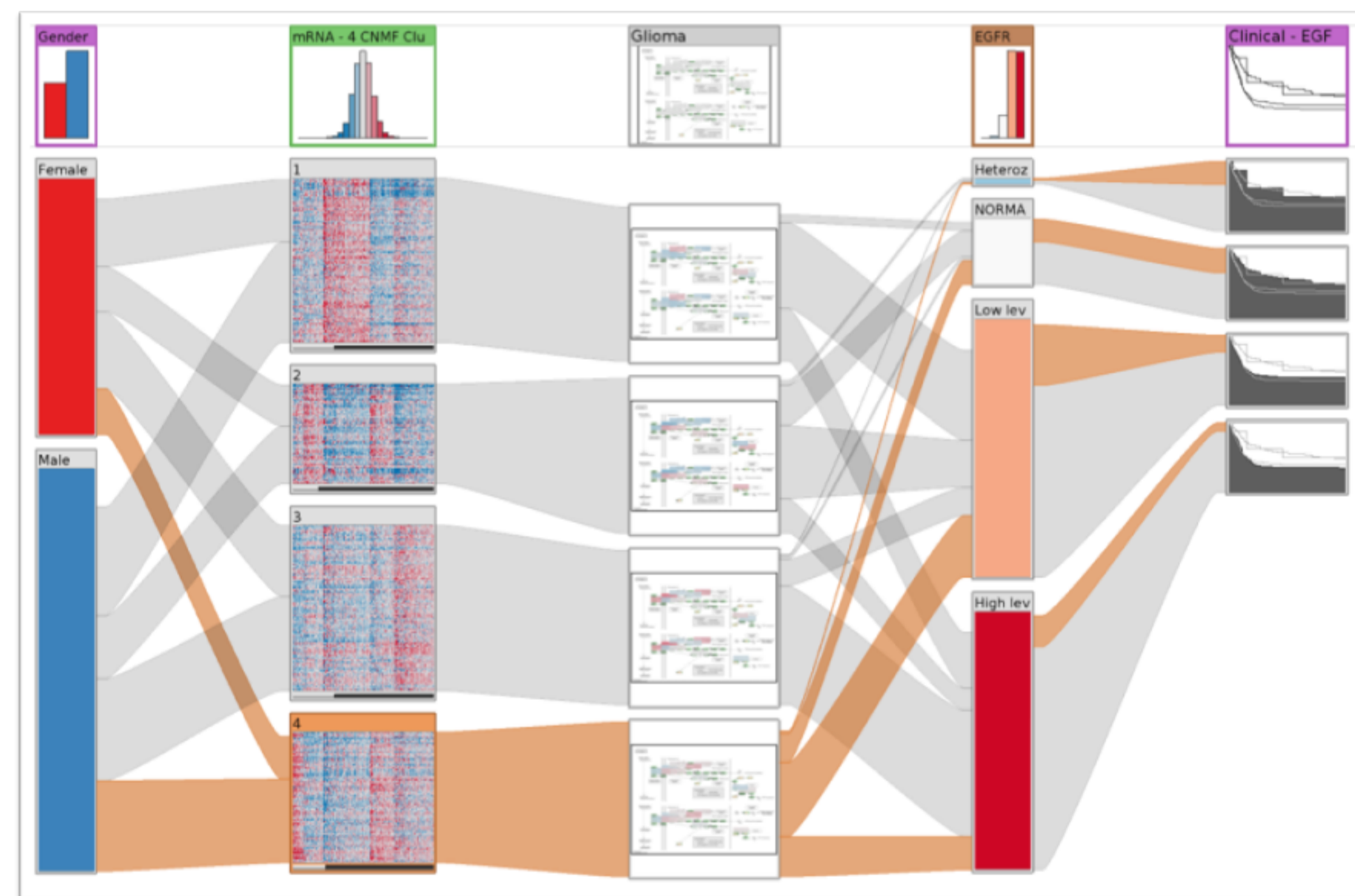

Nature Methods, 2014
CG & A 2014
EuroVis 2012
3rd Best Paper

Faceted Browsing of Graphs Drug Discovery

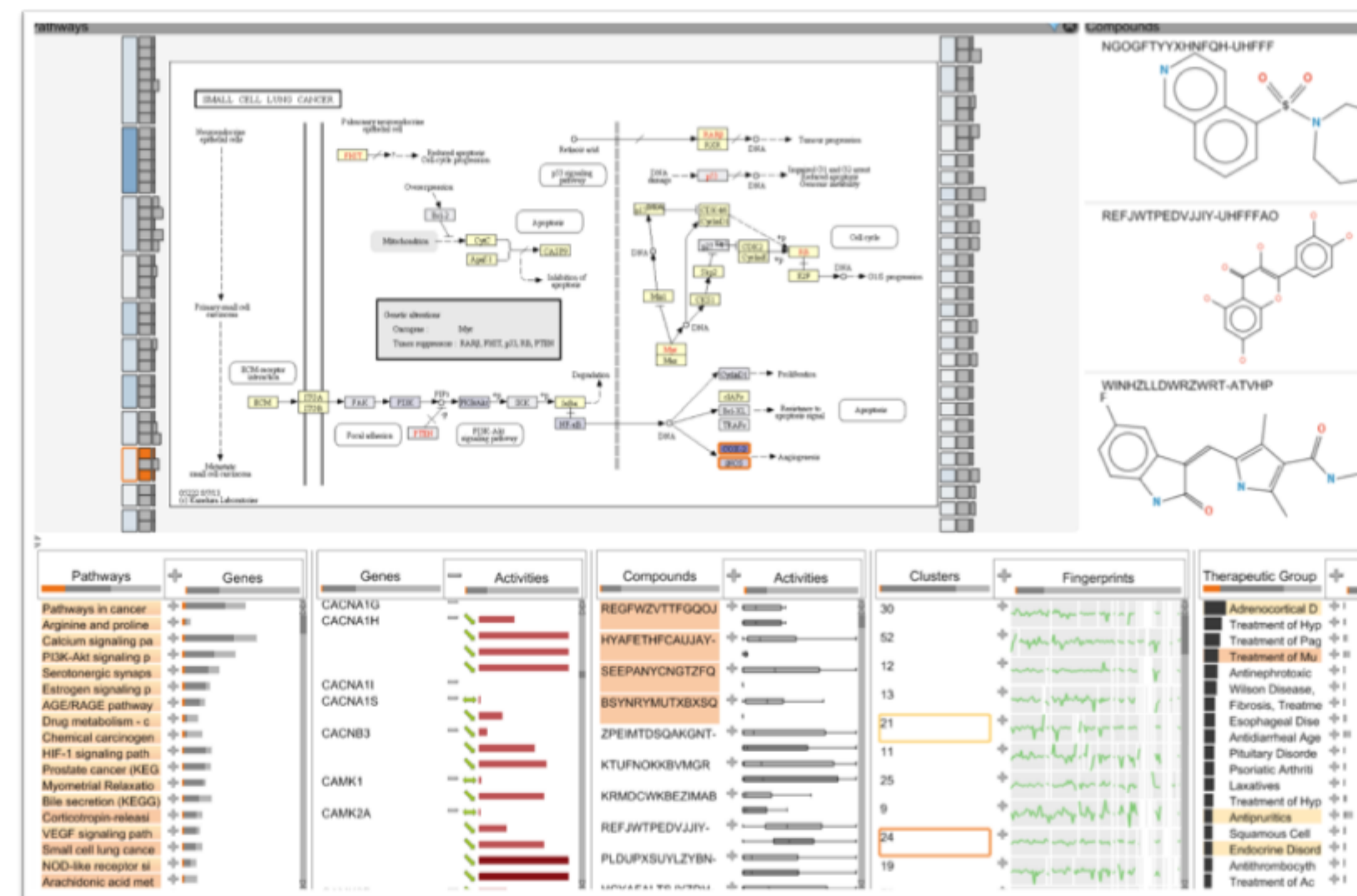

IEEE TVCG (VAST '14)

Protein Sequence Analysis

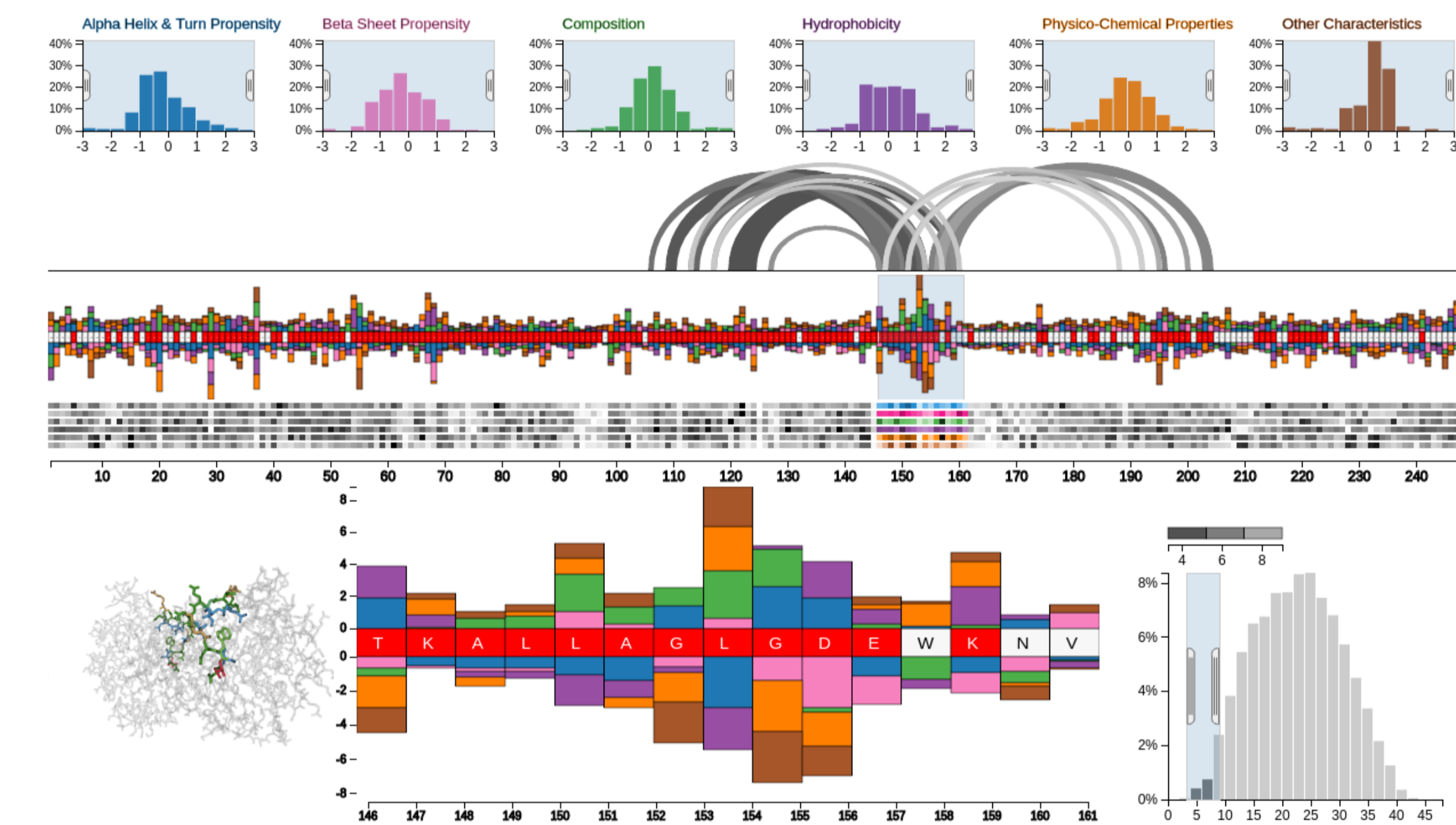

BMC Proceedings 2014

Home

About

Caleydo is an open source visual analysis framework targeted at biomolecular data. The biggest strength of Caleydo is the visualization of interdependencies between multiple datasets. Caleydo can load tabular data and groupings/clustering. You can explore relationships between multiple groupings, between different datasets and see how your data maps onto pathways. Caleydo has been successfully used to analyze mRNA, miRNA, methylation, copy number variation, mutation status and clinical data as well as other dataset types.

All published parts of the software are available as open source. Developers and researchers that want to use or enhance the current tools are invited to contribute. See our [Github page](#) for further details.

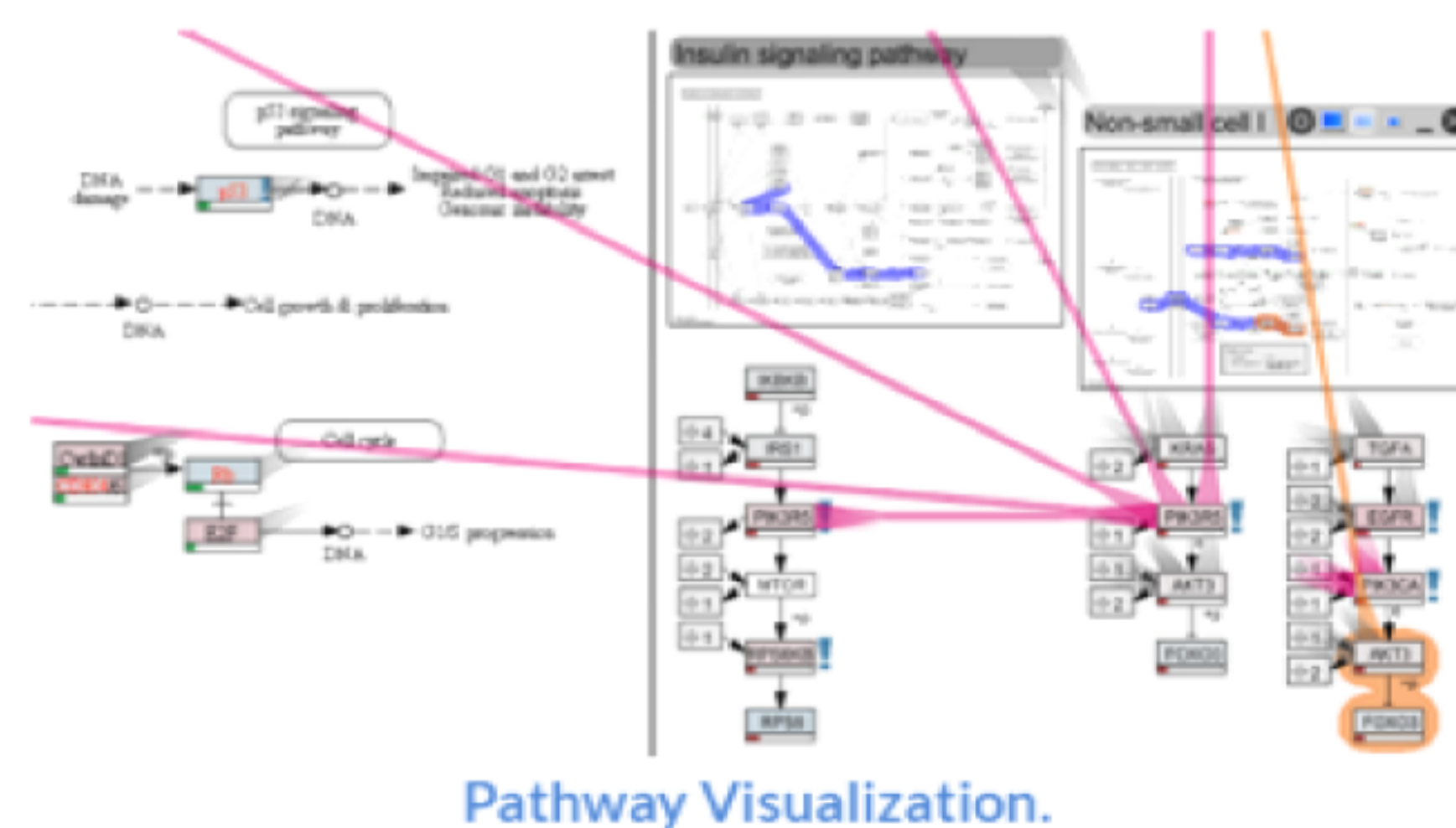

Partners

-  [Graz University of Technology](#)
Graz, Austria
-  [Johannes Kepler University Linz](#)
Linz, Austria
-  [Harvard University](#)
Cambridge, MA, USA
-  [Harvard Medical School](#)
Boston, MA, USA

Projects

-  [StratomeX](#)
Genomic Stratification of Diseases
-  [Entourage & enRoute](#)
Experimental Data in Pathways
-  [LineUp](#)
Multi-Attribute Rankings
-  [ConTour](#)
Relational Data in Drug Discovery
-  [Domino](#)
Exploring Subsets of Tabular Datasets
-  [Furby](#)
Bicluster Exploration
-  [Visual Linking & Hidden Content](#)
Showing Relationships

RESEARCH CHALLENGES

Interacting with Data

**The Future of Data Analysis
is (also) Interactive**

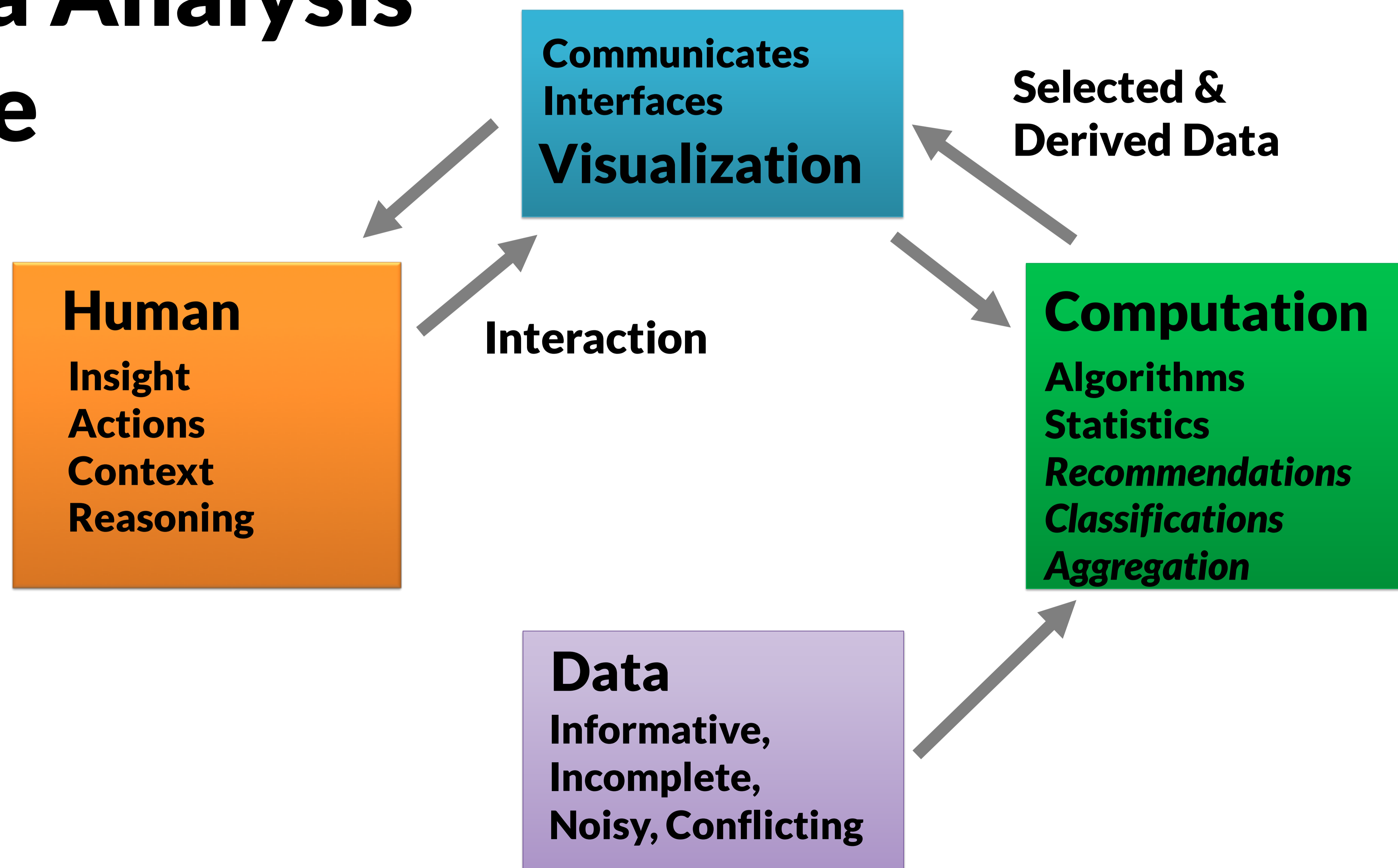

Can we make creating interactive vis systems easier?

Right now: prerogative of skilled software developers

Goal: democratize the creation of visualizations

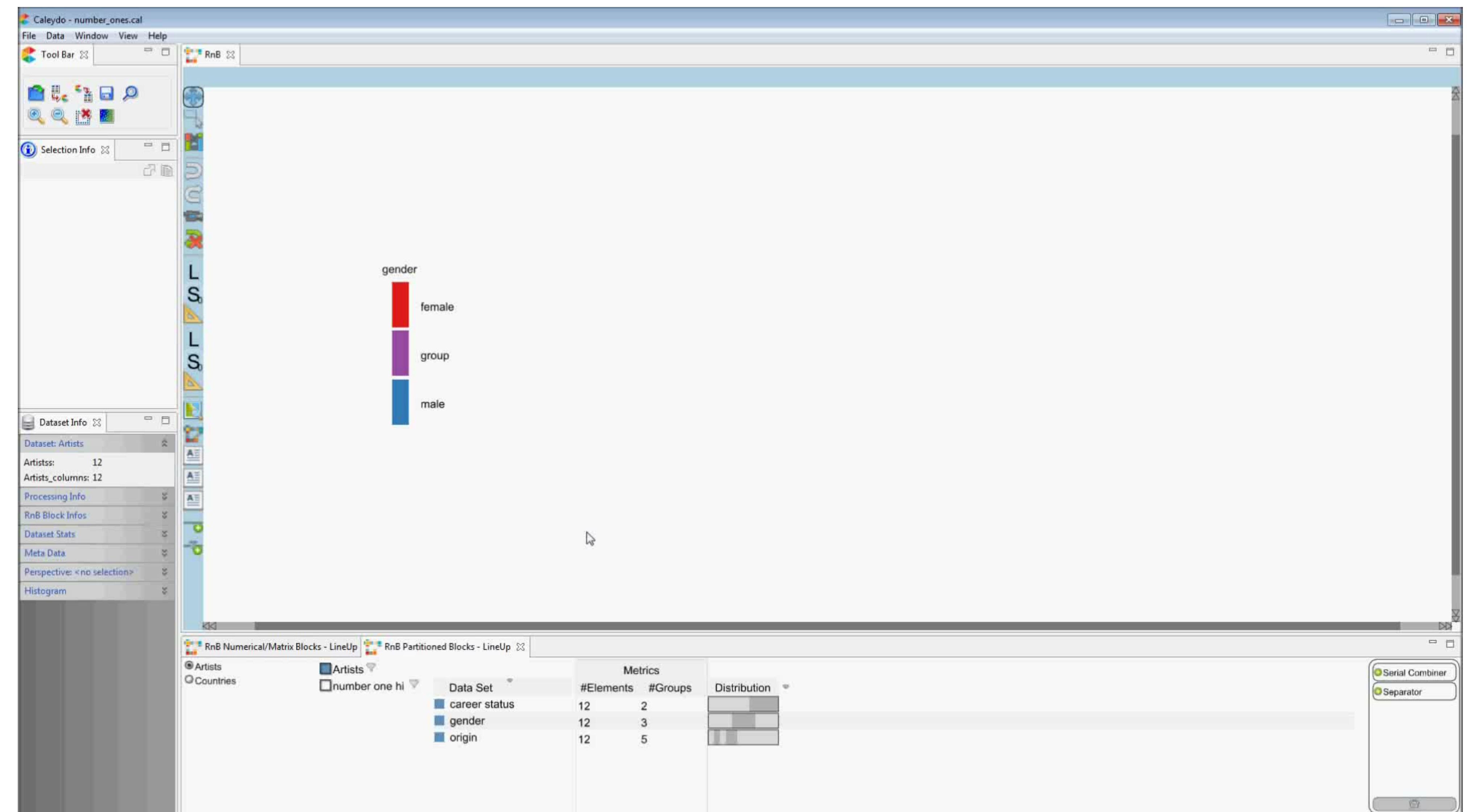

How can we scale to increasingly big datasets?

No local copies of datasets

No in-memory processing

....

Approach:

Automatic slicing into subsets

Query or explore ranked subsets

Pull in relationships for subset

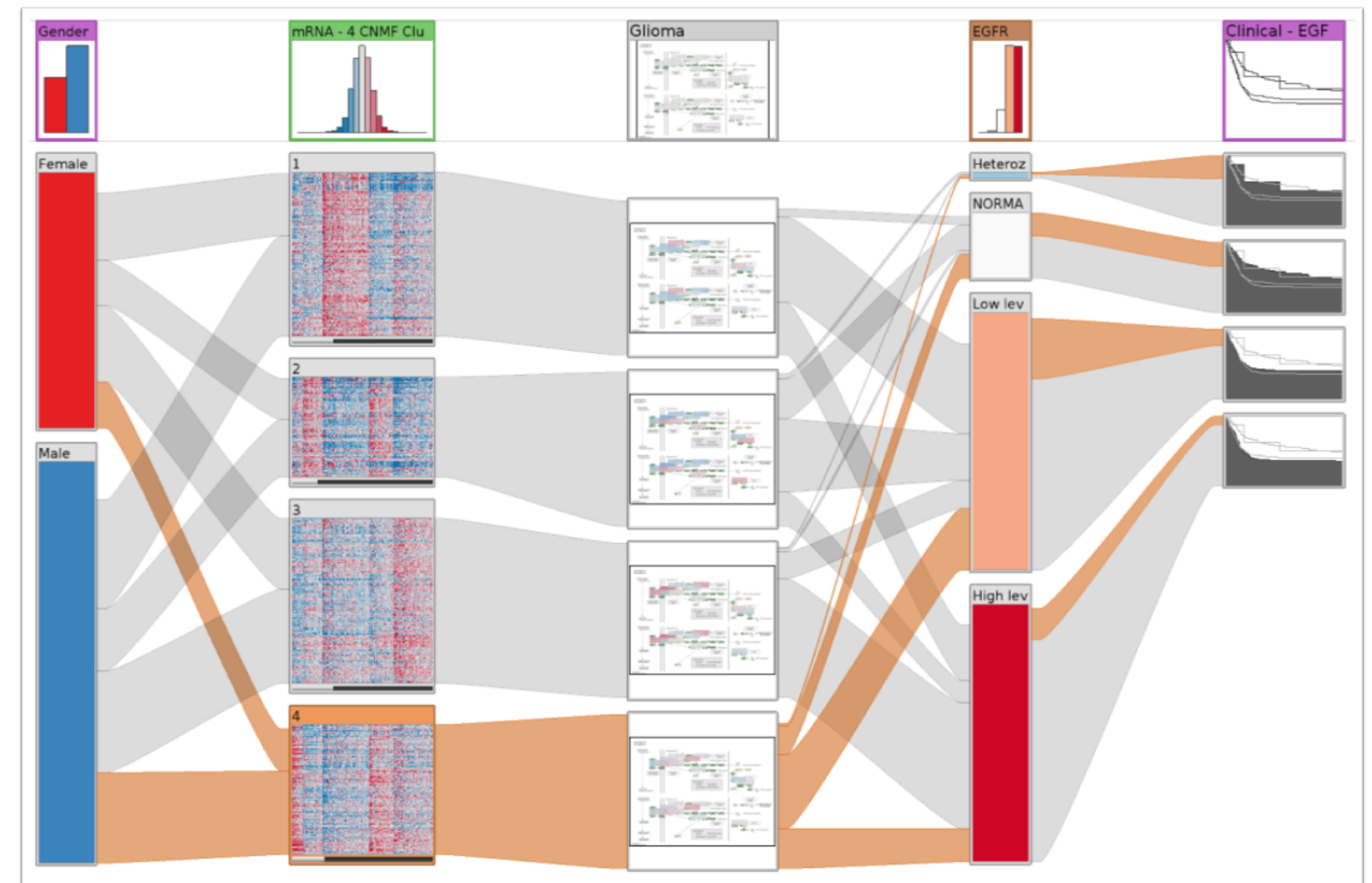
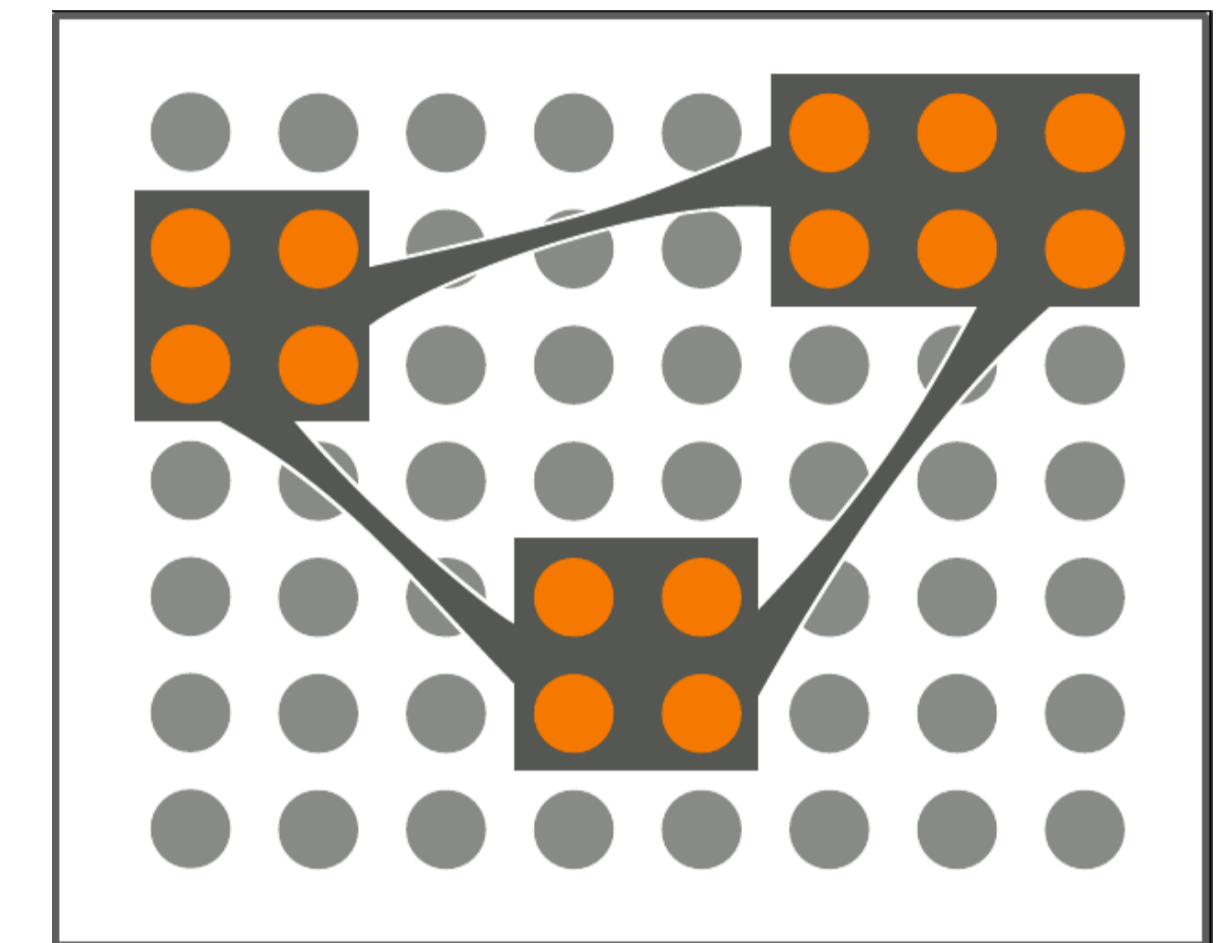



Enabling Scientific Discovery through Interactive Visual Data Analysis

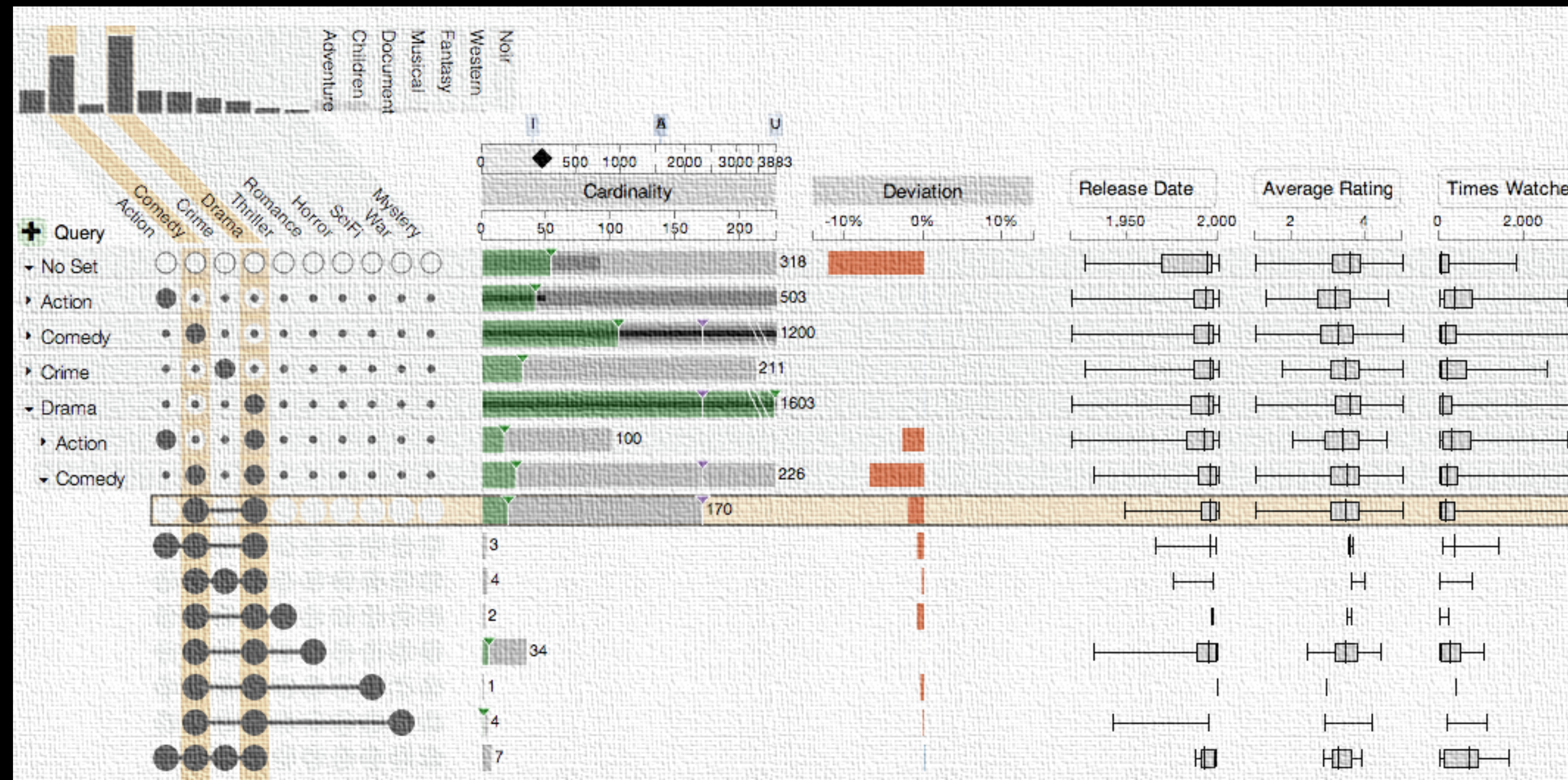

Credits:

Marc Streit, Nils Gehlenborg,
Christian Partl, Samuel Gratzl,
Markus Steinberger, Manuela
Waldner, Hendrik Strobelt, Romain
Vuillemot, Dieter Schmalstieg, Denis
Kalkofen, Mark Borowsky, Anne Mai
Wasserman, Hanspeter Pfister